



PART 9

PARRAMATTA CITY CENTRE



CONTENTS

9	PARRAMATTA CITY CENTRE.....	1
9B	AUTO ALLEY (WEST).....	389

PARRAMATTA CITY CENTRE

9.1	INTRODUCTION.....	1
9.1.1	APPLICATION	1
9.1.2	GENERAL OBJECTIVES.....	2
9.2	DESIGN QUALITY	3
9.3	BUILT FORM.....	5
9.3.1	GUIDING PRINCIPLES.....	5
9.3.2	MINIMUM SITE FRONTAGE	6
9.3.3	THE BUILDING ENVELOPE	6
9.3.4	THE STREET WALL.....	16
9.3.5	THE GROUND FLOOR	18
9.3.6	ABOVE GROUND PARKING.....	32
9.3.7	RESIDENTIAL APARTMENT DESIGN QUALITY.....	33
9.3.8	WINTERGARDENS	34
9.3.9	DWELLING MIX AND FLEXIBLE HOUSING	35
9.4	PUBLIC DOMAIN	36
9.4.1	SOLAR ACCESS TO SIGNIFICANT PARKS AND SPACES	37
9.4.2	AWNINGS AND TREES ON STREETS.....	44
9.4.3	DESIGN OF AWNINGS	49
9.4.4	PEDESTRIAN LANES, SHARED ZONES AND SERVICE LANES.....	51
9.4.5	PEDESTRIAN OVERPASSES AND UNDERPASSES	54
9.4.6	VEHICLE FOOTPATH CROSSINGS.....	54
9.4.7	VIEWS.....	57
9.5	SPECIAL AREAS	60
9.5.1	CITY RIVER.....	61
9.5.2	CIVIC LINK	69
9.5.3	GEORGE STREET.....	83
9.5.4	CHURCH STREET.....	87
9.5.5	MARION STREET	90
9.5.6	CAMPBELL STREET & GREAT WESTERN HIGHWAY	96
9.5.7	AUTO ALLEY	102
9.5.8	STATION STREET WEST.....	110
9.5.9	CREEK CORRIDORS	114
9.5.10	PARK EDGE HIGHLY SENSITIVE AREA.....	116
9.5.11	CHURH STREET NORTH.....	125
9.6	HERITAGE.....	138
9.6.1	GUIDING PRINCIPLES.....	138

9.6.2	UNDERSTANDING THE PLACE.....	140
9.6.3	HERITAGE RELATIONSHIPS.....	141
9.6.4	DEMOLITION	144
9.6.5	AMALGAMATION OF LOTS.....	145
9.6.6	DEVELOPMENT TO BENEFIT A HERITAGE ITEM	146
9.6.7	INTERPRETATION	148
9.7	FLOOD RISK MANAGEMENT	149
9.7.1	ASSESSMENT AND MINIMISATION OF FLOOD HAZARDS, RISKS AND POTENTIAL FOR HARM.....	150
9.7.2	LAND USE AND BUILDING LEVELS	153
9.7.3	SENSITIVE AND CRITICAL USES	155
9.7.4	FLOOD WARNING AND EMERGENCY RESPONSE PLANNING	155
9.7.5	DEVELOPMENT IN AND NEAR FLOODWAYS, RIPARIAN ZONES AND NATURALISED CHANNELS	158
9.7.6	CONTROLS FOR FLOODWAYS.....	158
9.7.7	CONTROLS FOR PARRAMATTA RIVER BANK AND FORESHORES	160
9.7.8	CAR PARK BASEMENTS IN FLOOD PRONE AREAS	161
9.8	ENVIRONMENTAL SUSTAINABILITY.....	164
9.8.1	HIGH PERFORMING BUILDINGS.....	164
9.8.2	DUAL WATER SYSTEMS.....	166
9.8.3	ALL ELECTRIC BUILDINGS.....	167
9.8.4	ELECTRIC VEHICLE CHARGING INFRASTRUCTURE	168
9.8.5	URBAN COOLING	169
9.8.6	SOLAR LIGHT REFLECTIVITY (GLARE).....	176
9.8.7	NATURAL REFRIGERANTS IN AIR CONDITIONING.....	177
9.8.8	BIRD FRIENDLY DESIGN	178
9.8.9	WIND MITIGATION	179
9.9	VEHICULAR ACCESS, PARKING AND SERVICING	184
9.9.1	VEHICLE DRIVEWAYS AND MANOEUVRING.....	184
9.9.2	ON SITE CAR PARKING.....	185
9.9.3	BICYCLE PARKING AND END OF JOURNEY FACILITIES	186
9.10	SITE SPECIFIC CONTROLS	184
9.10.1	PARRAMATTA SQUARE	191
9.10.2	57, 63 AND 83 CHURCH STREET AND 44 EARLY STREET	204
9.10.3	180 GEORGE STREET	215
9.10.4	2-10 PHILLIP STREET	219
9.10.5	184-188 GEORGE STREET	233
9.10.6	2-6 HASSALL STREET.....	239
9.10.7	12A PARKES STREET	245

9.10.8	14-20 PARKES STREET, HARRIS PARK.....	249
9.10.9	55 AIRD STREET	253
9.10.10	142-154 MACQUARIE STREET, 118 HARRIS STREET AND 135 GEORGE STREET	258
9.10.11	33-34 MARION STREET	277
9.10.12	2 O'CONNELL STREET, PARRAMATTA	280
9.10.13	12 HASSALL STREET	287
9.10.14	20 MACQUARIE STREET	294
9.10.15	197 AND 207 CHURCH STREET AND 89 MARSDEN STREET	305
9.10.16	18-40 ANDERSON STREET	317
9.10.17	89-91 GEORGE STREET	329
9.10.18	8-14 GREAT WESTERN HIGHWAY	339
9.10.19	8-12 VICTORIA ROAD AND 2A VILLIERS STREET	347
9.10.20	470 CHURCH STREET, PARRAMATTA	352
9.10.21	65-79 MACQUARIE STREET, 38 HUNTER STREET, 195 CHURCH STREET AND 45 HUNTER STREET, PARRAMATTA (ST JOHN'S ANGLICAN CATHEDRAL).....	356

9.1 INTRODUCTION

9.1.1 APPLICATION

The controls in this Part apply to the Parramatta City Centre the Land Application Map, below. The controls in this Part support the controls contained in Part 7 of *Parramatta LEP 2023*.

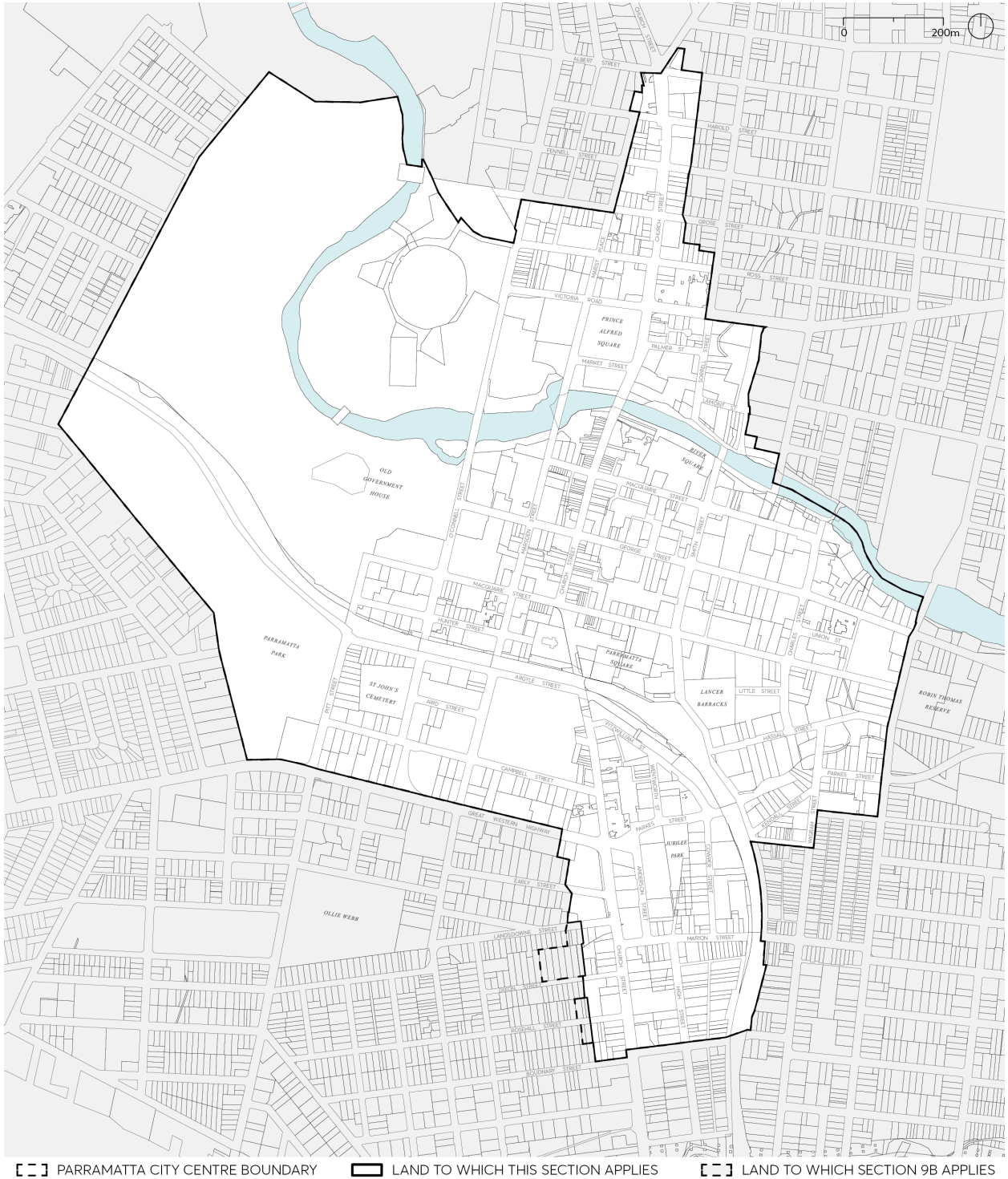

Figure 9.1.1 – Land Application Map – Parramatta City Centre

A further exception to the application of this Part is that the controls for the Park Edge Highly Sensitive Area (situated within the deferred Area A) are contained in this Part (see 9.5.10 – Park Edge Highly Sensitive Area). The intent of the CBD Planning Proposal process was to retain existing DCP and LEP controls for the Park Edge precinct. So the controls for this precinct reflect the controls that applied to this precinct prior to the introduction of Part 9.

9.1.2 GENERAL OBJECTIVES

The City of Parramatta aims to foster the development of a lively, diverse and healthy City Centre, one which celebrates a sense of place and local character in both the public and private realms. The way people experience the city is an underlying consideration for all the objectives and controls in this Part of the DCP.

The clarity and quality of public spaces is essential to this conception of a City Centre focused on people. The public spaces – streets, squares and parks – are the basic and enduring structuring spaces of a city, of which streets are the most prevalent. The interaction of buildings and public spaces is critical in shaping the activities of the City Centre, which occur most intensely at the lower levels, where detail design plays an important part in the creation of an engaging pedestrian environment.

General Objectives

- O.01 Create a legible, coherent and attractive City Centre characterised by lively streets of human scale and detail, and a distinctive skyline of tall, slender towers set back from the streets.
- O.02 Ensure that the spaces of the public domain - streets, squares and parks - are of high quality and amenity.
- O.03 Contribute to a thriving City Centre at street level with a well-designed interface at active frontages.
- O.04 Prioritise pedestrian movements to enhance pedestrian safety and enjoyment of the city.
- O.05 Promote urban and architectural design quality through planning procedures that foster design excellence.
- O.06 Protect public parks and places from undue environmental impacts from development.
- O.07 Reinforce the distinctive attributes and qualities of Special Areas in the City Centre.
- O.08 Protect and celebrate heritage and provide for its conservation and interpretation.
- O.09 Manage flood waters to protect and enhance the quality of the public domain and private property in the City Centre.
- O.10 Limit the impact of growth and development on the City Centre environment with reduced energy and water use, greenhouse gas emissions and urban heat.
- O.11 Protect and improve the natural environment.

9.2 DESIGN QUALITY

The promotion of good design in the built environment is an objective in the *Environmental Planning and Assessment Act 1979* and good design is a central aim for all development in the City Centre.

Design is a complex synthesis of multiple factors - technical, social, environmental, historic, aesthetic and economic. It responds to the context, physical as well as cultural, and generates sustainable living and working environments. It is concerned not only with how buildings look but includes fundamental considerations of amenity for occupants and how buildings contribute to the development of quality urban places.

Good design generates spaces with a sense of appropriateness in which people naturally feel comfortable. It has detail and material quality, is long lasting, and it creates financial return through the making of places that people value.

Good design also incorporates an understanding that individual buildings should relate to each other as well as contribute to a larger whole. This conception of the importance of collective urban form is an underlying principle of the City Centre controls.

Design quality procedures aim to include design quality as an integral part of development in the City Centre. An important aspect of this is to ensure that design intent is documented in detail and carried through all stages of projects to completion.

Objectives

- O.01 Ensure that development individually and collectively contributes to the architectural and overall urban design quality of the City Centre.
- O.02 Incorporate design quality in public and private development as a central consideration through all stages of the process from design to completion.
- O.03 Ensure that this DCP section is used as the basis for all Design Excellence competition processes.
- O.04 Promote quality design through a competitive design process for large and prominent developments.

Controls

- C.01 All Design Competition briefs must contain a reference to the objectives and controls in Part 9 of this DCP.
- C.02 All Design Competition briefs should comply with the City Centre DCP controls in this Part.
- C.03 All Architectural Reference Design building envelopes included in any Design Competition should be consistent with all City Centre DCP controls.
- C.04 Architectural Reference Design building envelopes with variations to the controls in this Part will only be permitted where Council is satisfied the variations are minor and the objectives of Part 9 are clearly satisfied.

- C.05 Where Council is not satisfied that proposed variations are consistent with the objectives in this Part, an applicant may pursue the following processes to allow Council to determine the appropriateness of the variation from the City Centre DCP controls prior to any Design Competition proceeding:
- a) the preparation and approval of a Site Specific DCP; or
 - b) the preparation and approval of a Stage 1 Concept DA.
- C.06 The Parramatta City Centre DCP controls (except where they are varied by a site specific DCP or Stage 1 Concept Development Application applicable to the site) will then form the primary basis of assessment of all Design Excellence winning schemes within the City Centre.

Note – Refer also to Section 9.3.3.2 – Building Separation

9.3 BUILT FORM

9.3.1 GUIDING PRINCIPLES

The Active frontages clause for the Parramatta City Centre require active ground floor street frontages for a large part of the City Centre. In these areas, the envisaged city form is broadly made up of two components: a lower stratum of defined streets and public spaces, and an upper one of tall, slender towers. The street wall, aligned with and attached to adjacent street walls, is the collective architectural component that defines the street and forms its character. The towers, set back from the street wall and free standing, generate a different type of city form of detached towers above the streets.

In areas zoned MU1 Mixed Use that are not required to have active frontages, buildings with residential ground floors are possible. Where this occurs, the building is set back from the street, potentially generating a more fragmented built form at the lower levels. Here the role of landscape takes on added importance in defining the street, enriching its character and ensuring long term amenity.

The controls in this section apply to all developments in the Parramatta City Centre unless modified by Special Area controls.

The following principles apply to all development in the Parramatta City Centre:

- P.01 In streets with active ground floor frontages, the development model for the city is for the lower 4-6 storeys to collectively define and articulate the spaces of the public domain, with towers set back as clearly distinct free-standing buildings.
- P.02 In streets with active ground floor frontages, street walls are designed at appropriate heights to create spatially defined streets that are well proportioned, humanly scaled and finely grained, with facades of tactile material quality.
- P.03 Towers are set back above street walls to reinforce the scale of the streets, mitigate wind and urban heat impacts, enable views to the sky and protect amenity in streets and public places.
- P.04 The design of the street wall responds, where relevant, to the existing heritage context.
- P.05 Building depth, bulk and separation creates a city form that protects amenity, daylight penetration, views to the sky and privacy between adjoining developments and minimises the negative impacts of buildings on the amenity of the public domain.
- P.06 Towers are proportioned to maximise their slenderness of form.
- P.07 The design and materials selection of buildings and the public domain contribute to a high quality, durable and sustainable urban environment.
- P.08 The gross floor area permissible under the applicable maximum FSR for each Development Lot in some circumstances may not be achievable when all planning, urban design and assessment considerations are taken into account. These may include, but are not limited to, matters such as street and tower setbacks, width of street frontage, the shape and size of the

site, heritage curtilage, significant trees being retained, and significant archaeology on the site.

9.3.2 MINIMUM SITE FRONTAGE

Objectives

O.01 Ensure sites are of sufficient width to achieve:

- a) The necessary standard of amenity in relation to privacy, solar access, ventilation and outlook.
- b) Adequate building separation in accordance with this section of the City Centre DCP controls.
- c) Street activation to the required extent.
- d) Safe and efficient access and servicing.

O.02 Ensure development does not compromise potential development on adjacent sites.

Controls

C.01 A development lot must have a minimum street frontage width of 35 metres.

C.02 A corner lot must have a minimum frontage width of 35 metres for both streets.

C.03 Where a site has the minimum frontage width or more, it must nonetheless be demonstrated that the objectives of the control can still be satisfied.

C.04 Any development proposal for a site with less than 35 metres street frontage width must demonstrate how adjacent sites can be developed to their full potential.

9.3.3 THE BUILDING ENVELOPE

The building envelope resulting from the setbacks and heights outlined in this section constitute a three-dimensional volume within which, together with all other applicable controls, a coherent built form must be designed.

9.3.3.1 STREET SETBACKS

The primary distinguishing characteristic for purposes of establishing street setbacks relates to ground floor usage. There are two principal categories:

- The building has an active ground floor frontage with an attached street wall (that is, a street wall with zero side setback); or
- The building has a residential ground floor frontage.

In areas with active street frontages the street wall is the part of the development that has most impact on the street and public domain experience. Together with the attached adjacent street walls, all built to the street alignment, it defines and articulates the street with appropriate scale and detail. Above the street wall, towers must be set back and designed as separate detached buildings.

In areas with residential ground floors, the building must be set back from the street alignment, allowing an arrangement which balances the need for resident privacy as well as engagement with the street, and also provides the necessary space for landscape amenity, both for residents and the street.

In areas where ground floor usage is uncertain, primarily areas at the fringes of the City Centre zoned MU1 Mixed Use and not identified with an active street frontage on the Active Frontages Map, existing and possible future context must be taken into account in determining appropriate built form and ground floor arrangements.

Street setbacks and building separation controls outlined in this section contribute to the reduction of heat in the urban environment. View of sky is a significant factor in mitigating urban heat, refer Section 9.8 – Environment Sustainability.

Objectives

- O.01 Reinforce the spatial definition of streets and public spaces.
- O.02 Emphasise the street as a distinct spatial entity and design the street wall frontage with an appropriate human scale and sense of enclosure for the street.
- O.03 Ensure consistent street frontages along the street alignment.
- O.04 Recognise the variation in street frontage heights throughout the city and allow flexibility to respond to context.
- O.05 Protect daylight access at street level and permit views of sky from the street by providing setbacks above street frontage height that promote separation between buildings and assist in mitigating urban heat.
- O.06 Ensure that building form achieves comfortable public domain conditions for pedestrians, with adequate daylight, appropriate scale, and mitigation of urban heat and wind effects of tower buildings.
- O.07 Create a clear delineation between public and private space.
- O.08 Reinforce important elements of the local context including public spaces, heritage buildings, monuments and landscape elements.
- O.09 Provide space in residential areas for landscape amenity that also contributes to the public domain.
- O.10 Ensure that built form enables a healthy environment for street trees.

Controls

- C.01 For all buildings that have an active frontage:
- a) Street setbacks and heights must comply with Figure 9.3.3.1.1, except where stated otherwise in the Special Areas Section of this Part.
 - b) The street wall must be built to the street boundary a minimum of 14 metres and a maximum of 21 metres above the footpath level.
 - c) The tower above the street wall must be set back a minimum of 6 metres from the street boundary wall.
 - d) Only one step in the built form between the street wall and tower is permissible.
 - e) Setbacks above the street wall on corner sites apply to both streets.
 - f) The street wall on corner sites must incorporate a set back from the corner intersection for its full height, which may be splayed or curved, refer to Figure 9.3.3.1.2.
 - g) Development applications must be accompanied by a streetscape analysis to determine the most appropriate street wall height within the permissible range.
 - h) Refer to Sections 9.3.4 and 9.3.5 for controls relating to the design of the street wall and the ground floor.
- C.02 Where a development with an active frontage is affected by a widening notation on the Land Reservation Acquisition Map in *Parramatta LEP 2023*, a street wall with a recessed ground floor frontage may be considered, refer Figure 9.3.3.1.3. The detailed profile of the street wall must be determined in relation to the requirements and circumstances of each site and must be capable of consistent application for the block. Applicants should contact Council at the start of the design process to establish the street profile for the development.

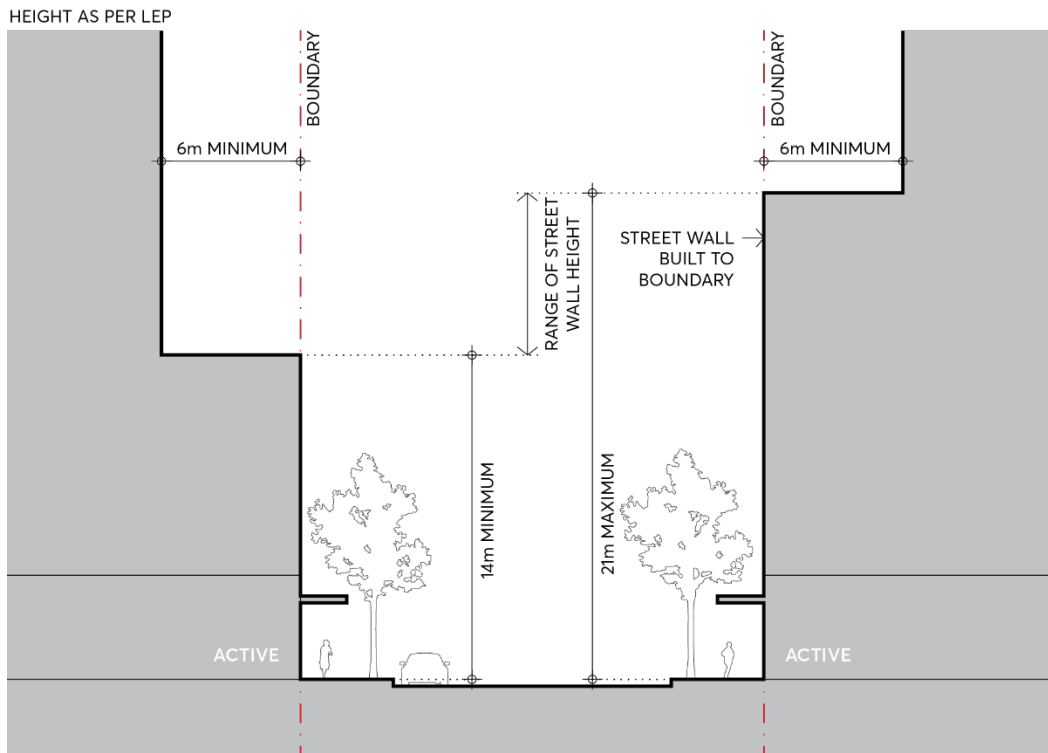

Figure 9.3.3.1.1 – Street Setbacks and Street Wall Height – Active Ground Floor Street Frontage

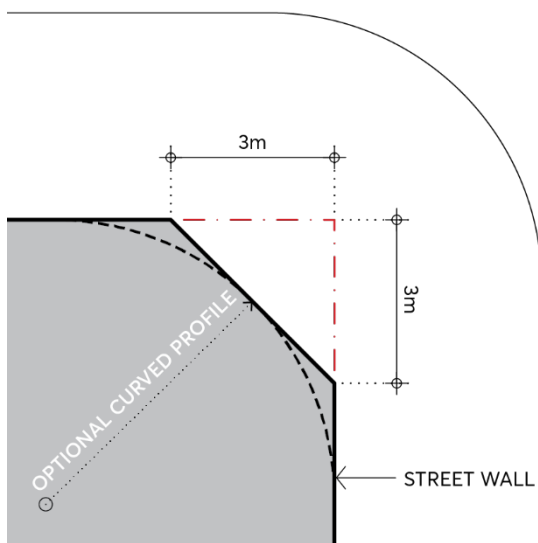
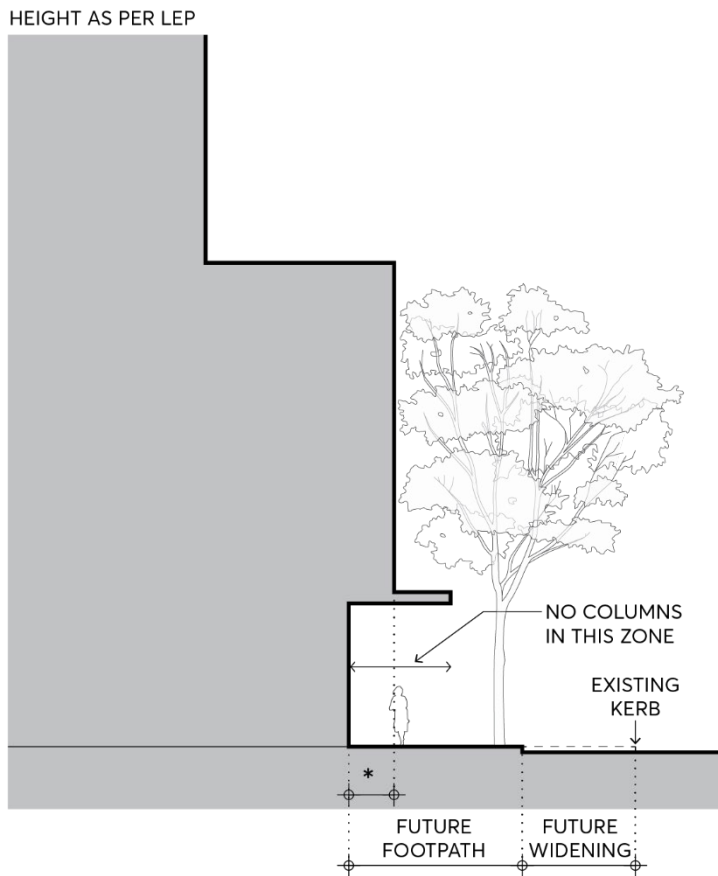

Figure 9.3.3.1.2 – Street Wall Corners



*A RIGHT OF WAY WITH BASEMENT BELOW MAY BE PERMITTED TO ACCOMMODATE FUTURE FOOTPATH WIDTH & SUPPORT STREET TREE PLANTING

Figure 9.3.3.1.3 – Street wall subject to LRA

C.03 For all buildings with a lane frontage:

- a) Street setbacks and heights must comply with Figure 9.3.3.1.4.
- b) The street wall must be built to the lane boundary a minimum of 14 metres and a maximum of 21 metres above the footpath level as shown in Figure 9.3.3.1.4.
- c) The tower above the street wall must be set back a minimum of 3 metres from the street wall as shown in Figure 9.3.3.1.4.
- d) The above setbacks are subject to building separation controls in Section 9.3.3.2.
- e) Only one step in the built form between the street wall and tower is permissible.

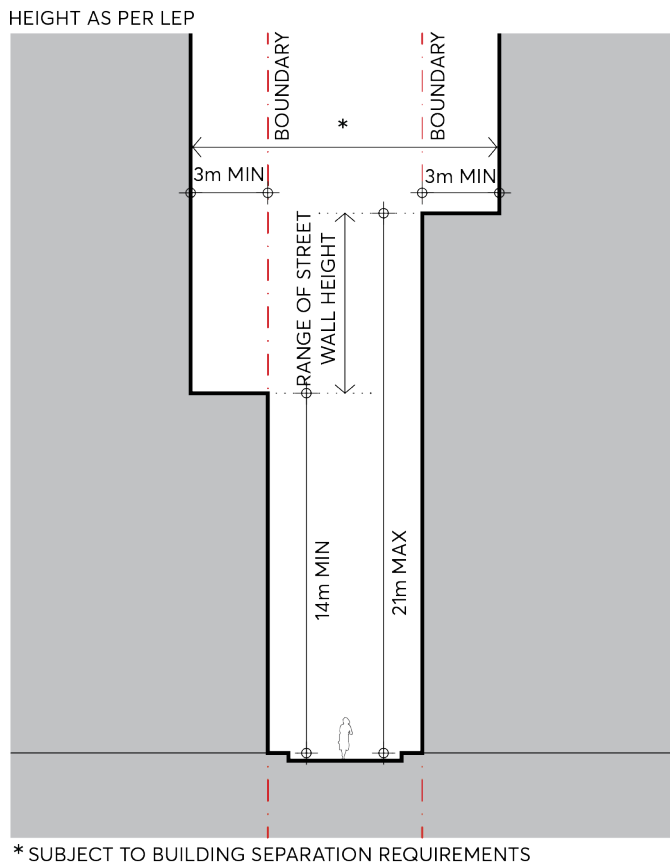

Figure 9.3.3.1.4 – Laneway Setbacks

C.04 For all buildings that have a residential ground floor street frontage:

- a) Street setbacks must comply with Figure 9.3.3.1.5.
- b) The building must be set back a minimum of 6 metres from the street boundary as shown in Figure 9.3.3.1.5.
- c) A 1 metre articulation zone is permitted forward of the setback, in which building elements may occupy a maximum of one third of the area of the facade. Services or lift shafts are not permitted in the articulation zone as shown in Figure 9.3.3.1.5.
- d) Refer to Section 9.3.5 – The Ground Floor for controls relating to the design of the ground floor.

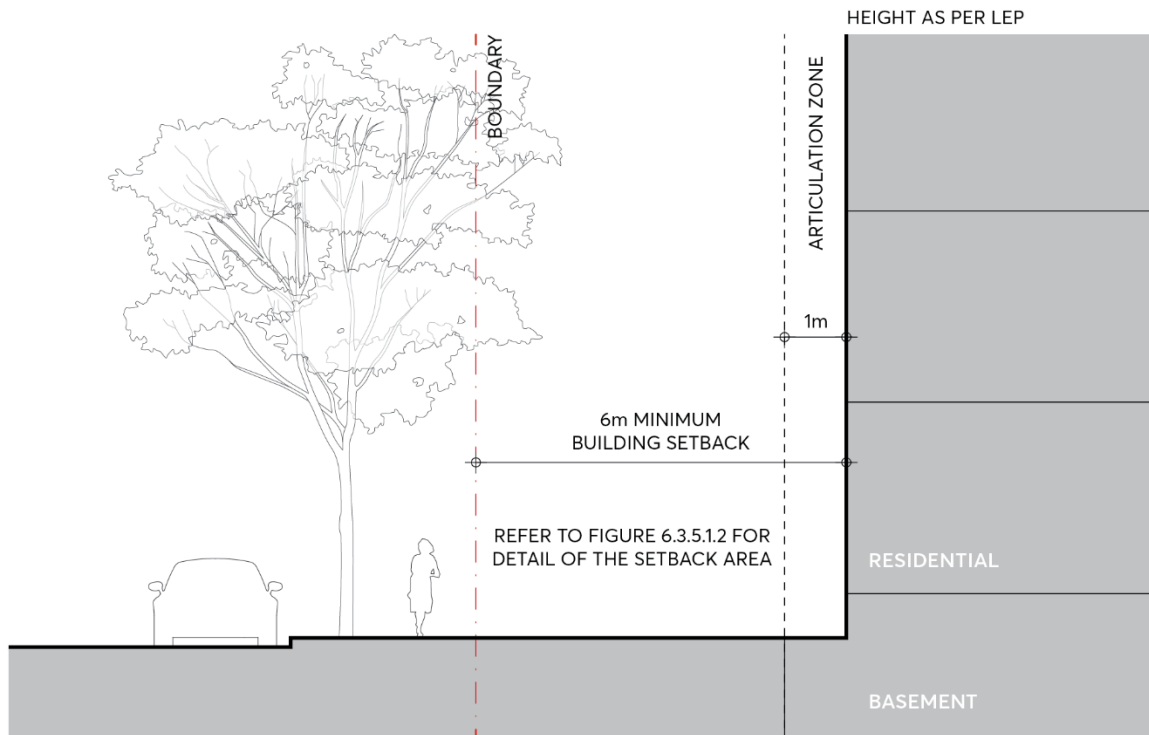

Figure 9.3.3.1.5 – Street Setbacks - Residential Ground Floor street frontage

- C.05 For sites that are zoned MU1 Mixed Use and are not required to have active ground floor street frontages in the LEP, an analysis of existing and likely future context must be submitted to determine the most appropriate ground floor uses, setbacks, and built form at the street frontage.
- C.06 Setbacks must be measured perpendicular to the boundary and extend to the outer faces of the building including balconies, sunscreens, and the like.

9.3.3.2 BUILDING SEPARATION

Objectives

- O.01 Protect the amenity of streets and public places by providing a healthy environment for street trees, and allowing adequate daylight and views to the sky.
- O.02 Provide adequate privacy, access to light, air and outlook for the occupants of buildings, neighbouring properties and future buildings.
- O.03 Ensure towers are sufficiently separated so that tower buildings are seen in the round.
- O.04 Ensure development does not prejudice the re-development of adjoining sites in the future.

Controls

- C.01 For commercial buildings in the E2 Commercial Centre zone, building separation above street wall height must be a minimum of 12 metres. The separation distance must be apportioned equally between adjacent sites to determine side and rear boundary setbacks. Refer Figure

- 9.3.3.2.1 A Commercial E2 zone. However, for commercial buildings in the E2 Commercial Centre zone seeking additional FSR consistent with Clause 7.28A in *Parramatta LEP 2023*, building separation above street wall height must be a minimum of 15 metres. The separation distance must be apportioned equally between adjacent sites to determine side and rear boundary setbacks. Variations to this will be considered but only when varied by a site specific DCP or Stage 1 Concept Development Application applicable to the site, and then forms the primary basis of assessment of a Design Excellence winning scheme.
- C.02 For residential buildings in the MU1 Mixed Use zone that have a residential ground floor, building separation must be a minimum of:
- a) 12 metres up to 4 storeys.
 - b) 18 metres over 4 storeys.
- C.03 The above separation distances must be apportioned equally between adjacent sites to determine side and rear boundary setbacks. Refer Figure 9.3.3.2.1 B Residential MU1 zone.
- C.04 For mixed use buildings in the MU1 Mixed Use zone that have an active ground floor street frontage:
- a) Building separation above street wall height must be a minimum of 18 metres. The separation distance must be apportioned equally between adjacent sites to determine side and rear boundary setbacks.
 - b) An analysis of existing and possible future context must be submitted to determine the most appropriate built form below the street wall height at the side and rear boundaries.
- Refer Figure 9.3.3.2.1 C Mixed Use MU1 zone.
- C.05 Only one step in the built form is permissible.
- C.06 Separation must be measured to the outside face of the building including balconies, vertical and horizontal circulation, internal voids, and external walls.
- C.07 Separation must be measured perpendicular to the boundary to the outer faces of the building including balconies.
- C.08 For purposes of these controls, serviced apartments and build-to-rent apartments must be treated as a residential building.
- C.09 An existing adjacent building, even if heritage listed, cannot be used to justify a reduced setback which could compromise the development potential of the adjacent site in the future.

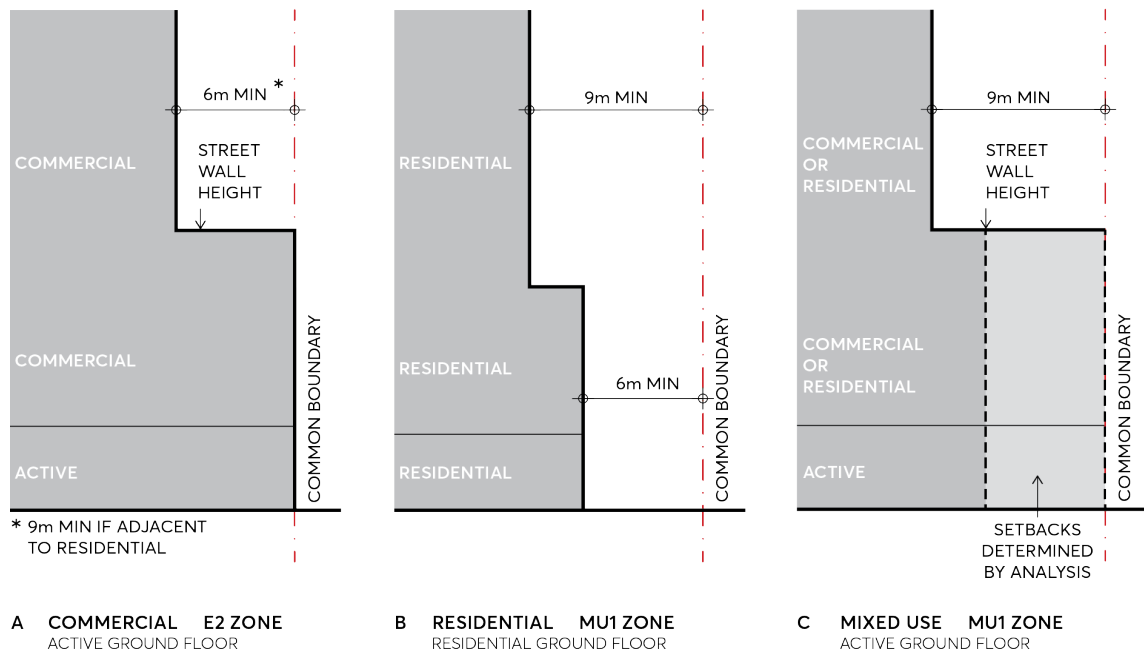

Figure 9.3.3.2.1 (A, B and C) – Building Separation

9.3.3.3 TOWER SLENDERNESS

The overarching objective of the City Centre controls is to generate a city form with well-defined streets of high amenity, and a skyline populated by tall slender towers.

The slenderness of towers is important both to achieve elegance of form as well as to maximise amenity and environmental performance. Plan area, plan proportion, and height are contributing factors in the perception of tower slenderness.

Objectives

- O.01 Generate towers of slender proportions to achieve elegance of built form.
- O.02 Mitigate the potential adverse effects that buildings may have on the public domain, including overshadowing, views to sky, urban heat, and wind effects.
- O.03 Achieve living and working environments with good internal amenity, including solar access, natural ventilation, outlook and external amenity of open spaces,
- O.04 Minimise the need for artificial heating, cooling and lighting.

Controls

- C.01 The maximum floorplate area for a commercial tower in the E2 Commercial Centre zone must be 2500 square metres.
- C.02 The maximum floorplate area for a commercial tower in the MU1 Mixed Use zone must be 2000 square metres.
- C.03 The maximum floorplate area for a residential tower must be:

- a) 800 square metres for a building which is less than 75 metres high.
 - b) 950 square metres for a building which is between 75-105 metres high.
 - c) 1100 square metres for a building which is greater than 105 metres high.
- C.04 Maximum floor plate areas are subject to achievement of the setback and separation controls as outlined in Sections 9.3.3.1 and 9.3.3.2.
- C.05 The maximum floorplate length for a commercial tower in the E2 Commercial Centre zone must be 60 metres.
- C.06 The maximum floorplate length for any tower in the MU1 Mixed Use zone must be 45 metres.
- C.07 The floorplate must be measured to the outside face of the building including balconies, vertical and horizontal circulation, internal voids, and external walls.
- C.08 Tower forms that are modulated into discrete elements are not considered as separate towers for purposes of these controls.

9.3.3.4 FLOOR HEIGHTS

Objectives

- O.01 Provide adequate amenity for building occupants.
- O.02 Ensure that floor heights support a range of uses and enable a change of use over time.
- O.03 Ensure that above ground parking has adequate ceiling heights to enable it to be converted to future residential accommodation.

Controls

C.01 Minimum floor to floor heights must be as follows:

	Minimum Floor to Floor Height (metres)
Commercial	3.8m
Residential	3.1m
Ground floor active street frontage	4.5m
Above ground parking:	
In the E2 Commercial Centre zone	3.8m
In the MU1 Mixed Use zone	3.1m

9.3.4 THE STREET WALL

Together with the public domain, the attached street wall with active ground floor frontage is the built element that shapes the way most of the city is experienced. As the primary means of providing definition and spatial enclosure to the streets and other public spaces, it is the principal architectural component of collective civic intent. That is, it must operate in concert with other street walls to form a satisfyingly rich experience for the public spaces of the city, and its modulation, articulation and character must be guided by this understanding of its role. Its design must be derived from the general characteristics that make successful streets: spatial definition of the street, human scale, urban grain, facades of tactile material quality articulated with depth and shadow.

Seen this way, the street wall can be thought of as a separate project to the design of the tower and can be distinct and different in character from the tower, but it should complement other street walls. In the foreground, it acts as a mitigating element for the set back tower building, able to define the street at the appropriate height and protect the street from the wind effects of the tower. The street wall height is set at a range that allows some flexibility with a maximum that generates a street width to height ratio in the order of 1:1.

Erosions or interruptions of the street wall generally work to undermine the vitality and definition of the street and are not favoured.

Objectives

- O.01 Define the space of the street and public spaces and articulate their edges.
- O.02 Design the street wall to provide appropriate scale, material quality and detail.
- O.03 Create visual interest and variety in the streetscape within an overall framework of consistency in the definition of the street and its character.
- O.04 Design the street wall to achieve fine grain modulation in the street.
- O.05 Encourage walkability by locating active uses in streets.
- O.06 Provide comfort and shelter for pedestrians.
- O.07 Minimise large expanses of inactive frontage.

Controls

- C.01 The street wall must:
 - a) Be built to the street alignment along its full frontage at all levels. Minor recesses in the profile for modulation and articulation are permissible.
 - b) Be modulated vertically in segments that relate to a fine grain subdivision pattern where the site frontage is more than 25 metres. Refer to Figure 9.3.4.1 – The Street Wall.
 - c) Be of predominantly masonry character with no lightweight panel construction or curtain walling.
 - d) Be articulated with depth, relief and shadow on the street facade. A minimum relief of 150mm between the masonry finish and glazing face must be achieved.

- e) Utilise legible architectural elements and spatial types - doors, windows, pilasters, sills, plinths, frame and infill, etc. - not necessarily expressed in a literal traditional manner.
 - f) Include an awning in accordance with Section 9.4.2 – Awnings and Trees on Streets.
 - g) Include a ground floor facade design which intensifies the walking experience with particular richness in detail, refer to Section 9.3.5 – The Ground Floor.
- C.02 Undercrofts or other interruptions of the street wall which expose the underside of the tower and amplify its presence on the street are not permitted.
- C.03 Green walls, screens and the like must not be used as an applied cover that masks the architectural attributes of the street wall facade. Greenery may be incorporated in the street wall so as to complement its required character as set out in C.01 and C.02 above.
- C.04 All development applications must include a streetscape analysis to determine the most appropriate street wall height and provide details of the street wall. Submissions must include:
- a) The street wall elevation at 1:200 scale in context showing existing buildings on the block.
 - b) A detailed street wall elevation at 1:100 scale including immediately adjacent buildings accurately drawn.
 - c) Sections through the street wall and awning at 1:50 scale including the public domain.
 - d) Detail street wall facade plans and sections at 1:20 scale, including ground floor active frontage and awning details, refer Sections 9.3.5, 9.4.2 and 9.4.3.

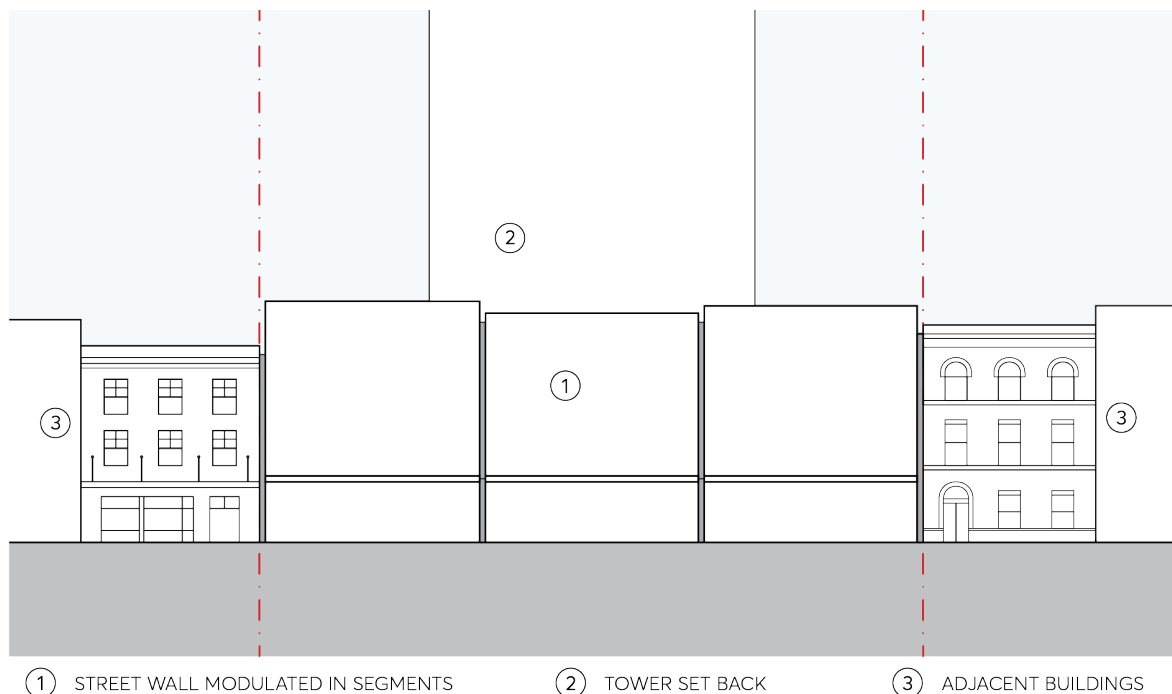

Figure 9.3.4.1 – The Street Wall

9.3.5 THE GROUND FLOOR

The active ground floor of the street wall is the part of the building that interfaces directly with the street or public domain. As such it has the most impact on the pedestrian experience, and its design must respond to the need for a lively, interesting and comfortable environment. Much of the success of this frontage, also critical to the success of the city, relies on a considered level of detail design and realization.

In the case of residential frontage at the ground floor, a different set of parameters applies, but its success is equally reliant on detailed consideration and treatment. Here, the building is set back from the street to afford a balance of privacy as well as engagement with the street for ground level residents, at the same time allowing space for a generous tree canopy providing amenity for the street and residents.

A large part of the City Centre is flood affected, which, among other implications, may significantly affect the design of the ground floor in these areas. Objectives and controls for the design of ground floors are covered below for sites that are not flood affected in Section 9.3.5.1 – Non Flood Affected Sites, followed by correlated provisions which apply for sites that are flood affected in Section 9.3.5.2 – Flood Affected Sites.

Ground level design and detail must be integrated with public domain requirements, refer Section 9.4 – The Public Domain.

9.3.5.1 NON FLOOD AFFECTED SITES

9.3.5.1.1 ACTIVE GROUND FLOOR FRONTAGE

The factors that make for a thriving active ground floor street environment are well established: a scale appropriate to the pedestrian, narrow shopfronts and many doors, a mix of tenancy types, good transparency to the inside, quality materials with expressed detail, vertically articulated facades (which make distances along the street appear shorter), and a plinth for the glazed frontages.

Where required, shelter and weather protection for pedestrians on footpaths must be provided by awnings. Colonnades are generally not favoured on streets as they restrict views of retail frontage and fragment the street interface, thereby undermining the intensity of public activity at the frontage. There may be limited situations where colonnades are considered reasonable, such as where they allow continuity of important view corridors.

Objectives

- O.01 Provide for the amenity, interest and liveliness of the street environment.
- O.02 Ensure a positive experience for pedestrians with the necessary fine grain environment of the street.
- O.03 Enable sensory engagement with the street.
- O.04 Provide an active ground floor frontage that is accessible and integrated with the design of the public domain.

- O.05 Maximise the extent of active frontages in the public domain.
- O.06 Ensure appropriate scale and proportion of foyers and lobbies in relation to site frontage.
- O.07 Promote activity, connectivity and variety in the public domain.
- O.08 Increase the number of safe routes of travel throughout the Parramatta City Centre.
- O.09 Increase passive surveillance of the street and enhance safety.
- O.10 Ensure security measures do not inhibit passive surveillance of the street.

Controls

- C.01 The following numeric parameters apply to active ground floor frontage:
 - a) Active uses must fully occupy the ground floor frontage not taken up by services or vehicular access.
 - b) The minimum depth of tenancy must be 4 metres, and tenancies must have an unobstructed view to a depth of 4 metres from the footpath.
 - c) Where the street frontage is identified as having an active frontage on the Active Frontages Map in *Parramatta LEP 2023*, the maximum internal tenancy width allowed for must be 6 metres. Where active street frontage is not nominated on the Active Frontages Map, the maximum internal tenancy width allowed for must be 10 metres.
 - d) Foyers and lobbies in the E2 Commercial Centre zone must be a maximum of 20% of the frontage width.
 - e) Foyers and lobbies in the MU1 Mixed Use zone must be a minimum of 3 metres and a maximum of 8 metres of the frontage width.
 - f) Where food and beverage premises have operable elements they must not be greater than 80% of the individual tenancy width.
- C.02 The active ground floor frontage must be considered in detail and the following must be incorporated in its design, refer Figure 9.3.5.1.1:
 - a) A nominal 500mm interface zone at the frontage must be set aside to create interest and variety in the streetscape, to be used for setbacks for entries, opening of windows, seating ledges, benches, and general articulation.
 - b) The ground floor levels and facade masonry frame must allow for tenancy widths as noted above in C.01.
 - c) The facade must have a high level of expressed detail and tactile material quality.
 - d) The base of the facade must achieve a well resolved meeting with the footpath that takes account of any slope. A horizontal plinth, integrated in the design, must be incorporated at the base of glazing to the footpath.
 - e) A clear path of travel must be provided in the public domain as defined in the [Public Domain Guidelines](#).
 - f) Legible entrances must be formed in the frontage.

- g) Fire escapes and service doors must be seamlessly incorporated into the facade with quality materials.
- h) The facade must not have deep recesses for entry lobbies that compromise safety.
- i) Colonnades are not permitted on streets. Awnings must be provided where required in accordance with Section 9.4.2 – Awnings and Trees on Streets.
- j) All required services must be incorporated in the design of the ground floor frontage at DA stage, refer Section 9.3.5.4 – Services and Utilities.
- k) Parking security grilles or doors must be aligned to the building edge as closely as safety constraints permit.
- l) Security doors or grilles must be designed to be fitted internally behind the shopfront, fully retractable and a minimum 50% transparent when closed.
- m) Refer to Section 9.3.5.2 – Flood Affected Sites for flood affected sites.

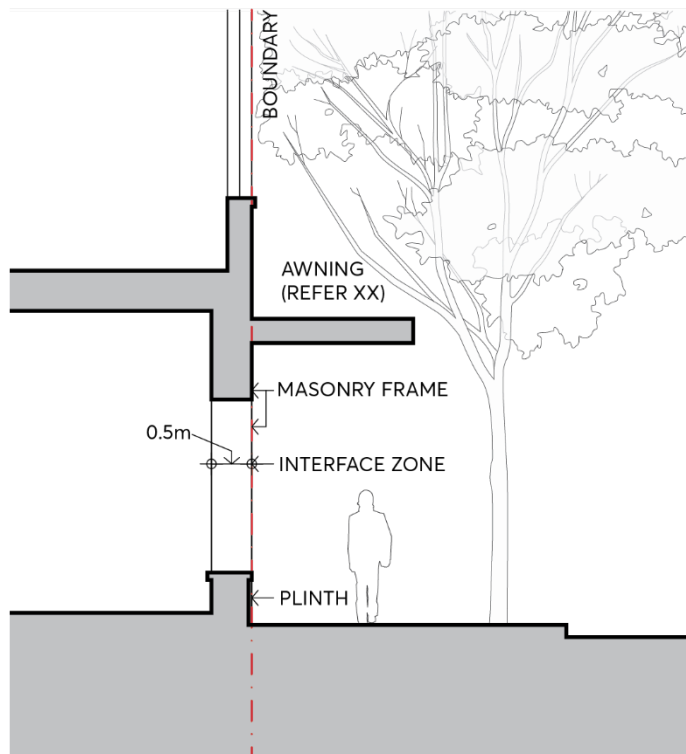

Figure 9.3.5.1.1 – Active Ground Floor Frontage

9.3.5.1.2 RESIDENTIAL GROUND FLOOR FRONTAGE

Residential buildings must be set back from the street boundary to provide amenity for ground floor residents, a landscaped setting for buildings, and a landscape character for the street.

The area between the facade and the street boundary must receive attention both in design and in its material quality. The subtleties involved in the design of ground level entries, private terraces or balconies, fences, walls, level changes and planting play an important part in the articulation of the street. A detailed resolution of these elements is essential in contributing to an unambiguous definition of public space, good street form, pedestrian scale, clarity of access and address, and a balance of privacy and passive surveillance. These details must all be designed with the same level of care given to the building.

The potential mix of possible street frontage conditions in the MU1 Mixed Use zone that are not identified as having an active frontage on the Active Frontages Map must be subject to analysis in each situation. Existing and possible future context and use must be taken into account in determining the optimum built form.

Objectives

- O.01 Establish new canopy trees that contribute to the landscape character of the street and residential amenity.
- O.02 Appropriately define and design the street edge and setback area to achieve amenity and privacy for residents as well as engagement with and passive surveillance of the street.

Controls

- C.01 The following parameters apply to residential ground floor street frontage, refer to Figure 9.3.5.1.1.
 - a) The building must be set back 6 metres from the street boundary. A 1 metre articulation zone is permitted forward of the setback, in which building elements may occupy a maximum of one third of the area of the facade. Services or lift shafts are not permitted in the articulation zone.
 - b) Basements must be set back a minimum of 5 metres from the street boundary measured to the outside face of structure to allow deep soil in the setback area.
 - c) The setback area must allocate the front 3 metres adjacent to the footpath as common property for landscaping. Canopy trees must be planted in this area, a minimum 3.5 metres from any structure, to achieve greater than 13 metres mature height and spread, at the rate of 1 canopy tree for every 15 lineal metres of frontage.
 - d) A wall set back 3 metres from the street boundary must articulate the front areas in private ownership. The wall must be a maximum 1.2 metres high and of masonry construction, integrated with dividing masonry walls for private open spaces.
 - e) Impervious surface at ground level must be minimised in the setback area.
 - f) Ground floor apartment levels must be a minimum of 500mm and maximum of 900mm above footpath level.

- g) All required services must be incorporated in the design of the ground floor frontage at DA stage, refer to Section 9.3.5.4 – Services and Utilities.
- h) Refer to Section 9.3.5.2 – Flood Affected Sites for flood affected sites.

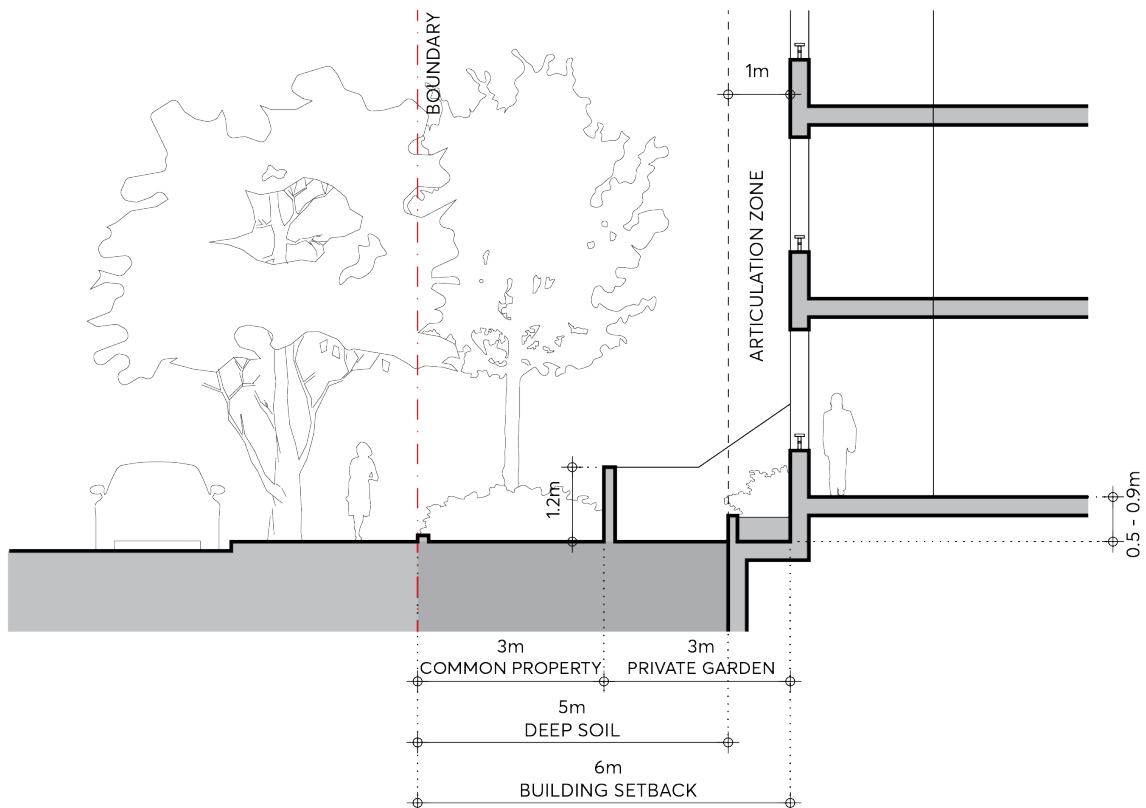

Figure 9.3.5.1.2 – Residential Ground Floor Street Frontage

- C.02 Where individual apartment entries from the street serve as a primary address, separation between the entry and private open space, and a front door with a distinct entry space within the apartment, must be provided. If the entries are only for the use of residents they must be understated, with post boxes and street numbers located at the common entry.
- C.03 All stairs and ramps providing access to lobbies must be internalised where necessary to ensure the street interface is not compromised.
- C.04 For sites that are zoned MU1 Mixed Use and not identified as having an active frontage on the Active Frontages Map, an analysis of existing and likely future context and use must be provided to determine the most appropriate built form and use at the street frontage.
- C.05 A fully illustrated and co-ordinated ground floor design, showing all the necessary levels and detail, must accompany development applications. Drawings must include the following:
- A detail ground level plan and sections as part of the architectural submission which illustrates the relationships between the interior and the exterior spaces of the setback area, including the landscape and hydraulic detail, and extends into the public domain.
 - Any required services must be discreetly integrated into the frontage design.
 - The architectural drawings must be fully co-ordinated with the landscape and hydraulic drawings.

- d) Elevations and sections at minimum 1:50 scale of all built elements in the setback area must be provided.

9.3.5.2 FLOOD AFFECTED SITES

Controls for flood affected sites in this section apply to land identified on the Floodplain Risk Management Map in *Parramatta LEP 2023*. This section should be read in conjunction with Section 9.7 – Flood Risk Management and follow the site planning and design responses outlined.

Flooding conditions can be a major constraint for any development and must be incorporated in the initial stages of design work. Applicants should contact Council's Flood Engineers at the beginning of the design process to establish the requirements and to avoid abortive work.

Flood affected sites generally require habitable floors to be raised above natural ground level, which may have important implications for ground level relationships with the public domain. In this section a number of possible arrangements at this interface are illustrated. In determining the appropriate layout for each development, the design must take into account and synthesize the flooding parameters, proposed ground level functions, and the context and conditions of the site.

Objectives

- O.01 Achieve comfortable, well-scaled transitions between the footpath and raised ground floors.
- O.02 Maximise adjacency and transparency between active frontages and the footpath.
- O.03 Where possible, allow for a common and co-ordinated approach for active frontages that provides continuity of raised flood levels along the street.

9.3.5.2.1 ACTIVE GROUND FLOOR FRONTAGE

For ground floors with active frontages, it may be preferable in some circumstances to retain the direct relationship that shop fronts generally have with pedestrians at the footpath level. This may be possible for a portion of the tenancy adjacent to the footpath, provided that certain safeguards and design measures are incorporated. This strategy is also relevant for established fine grain retail areas and for adaptive re-use of heritage buildings.

Where fully elevated ground floor tenancies above the public domain are required, this potentially breaks the visual and physical connections necessary for effective activation. The challenge is to tailor a design solution based on the individual flood risk and site constraints that best meets both the flood management requirements as well as the everyday prerequisites for activation.

Consideration must be given to existing and future adjacent development and the possibility of integrating any proposal into a co-ordinated street frontage. This may be more easily achievable in some circumstances, such as where one development occupies a large portion of the street frontage of the city block.

Controls

- C.01 Where Council considers it viable and in the public interest, particularly in a fine grain or heritage context, an area of the ground floor may be located at footpath level, refer Figure 9.3.5.2.1. This area must:
- Provide a safe and easy transition within the building that meets Australian Standard for Disabled access to the remainder of the tenancy located at the floor level required by Council for flood protection.
 - Have a maximum interior level change of 1 metre.
 - Comply with requirements listed in Section 9.7.2 – Land Uses and Building Levels.

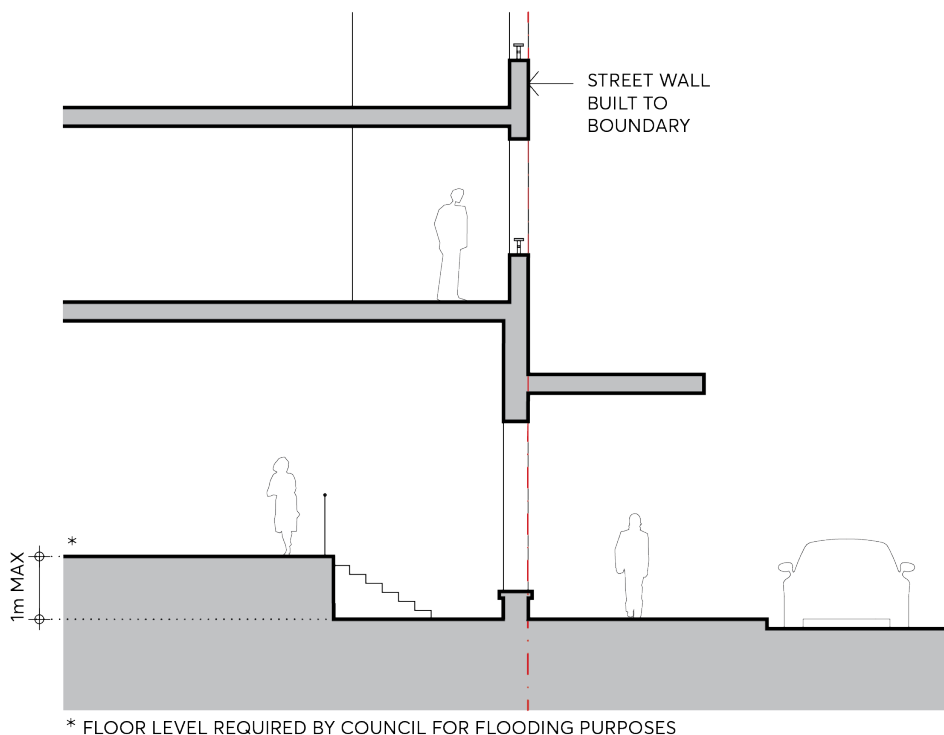
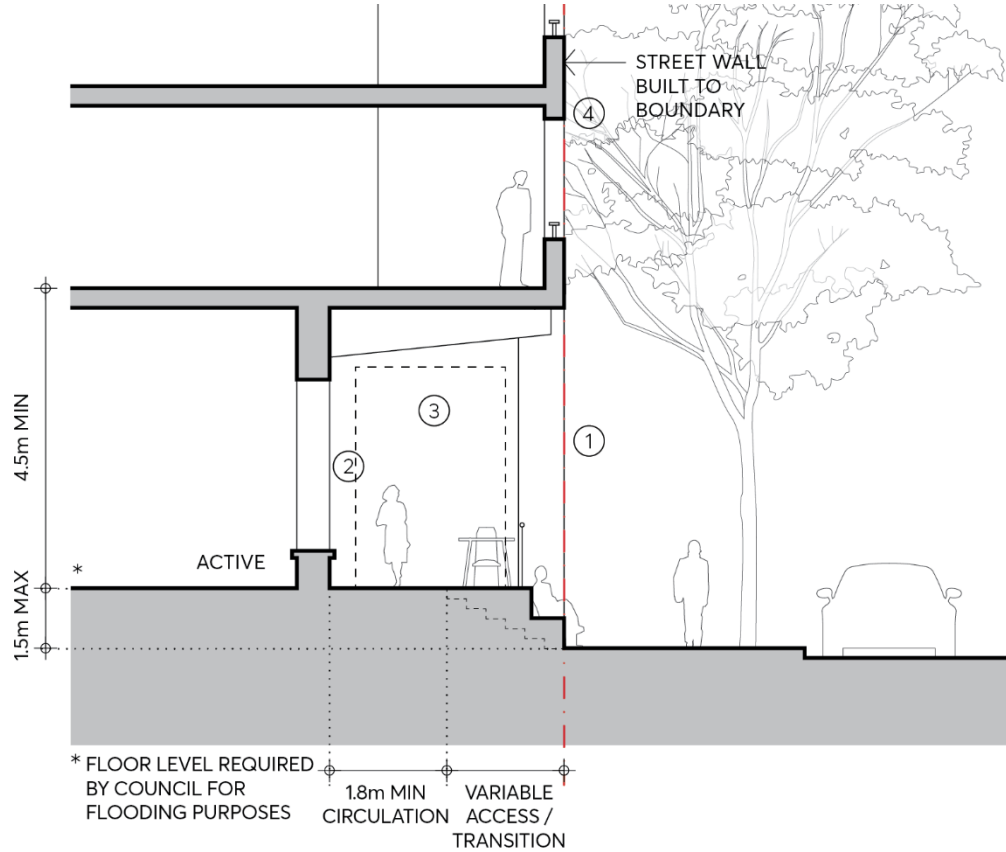

Figure 9.3.5.2.1 – Active Ground Floor: Floor level permitted partly at footpath level

- C.02 Where the floor level required by Council for flood protection is a maximum of 1.5 meters above footpath level the active frontage may be set back from the street boundary with access and transition adjacent to the footpath, refer to Figures 9.3.5.2.2 A and 9.3.5.2.2 B. In this case, the ground floor must:
- Have clear sightlines and maximise transparency and ease of circulation between the public footpath and upper circulation zone.
 - Comply with applicable active frontage controls in Section 9.3.5.1 – Non Flood Affected Sites.
 - Be free of structure outside of the active frontage except at intervals to modulate the street wall into vertical segments, refer to Figures 9.3.5.2.2 A and 9.3.5.2.2 B.
 - Have a minimum upper circulation zone width of 1.8 metres.

- e) Incorporate universal accessibility to the raised level, fully accommodated within the boundaries of the site.
- f) Allow for integration with existing and future development on adjacent sites. Side boundary walls extending to the street boundary must incorporate openings or removable sections to connect to existing or future development where this can be achieved.



- ① GROUND LEVEL STRUCTURE ONLY AT MODULATION OF STREET WALL
- ② ACTIVE FRONTAGE SET BACK, REFER TO SECTION 9A.3.5.1
- ③ POSSIBLE CONNECTION TO ADJACENT SITE
- ④ DESIGN OF STREET WALL, REFER TO SECTION 9A.3.4

Figure 9.3.5.2.2 A – The Street Wall: Active frontage set back

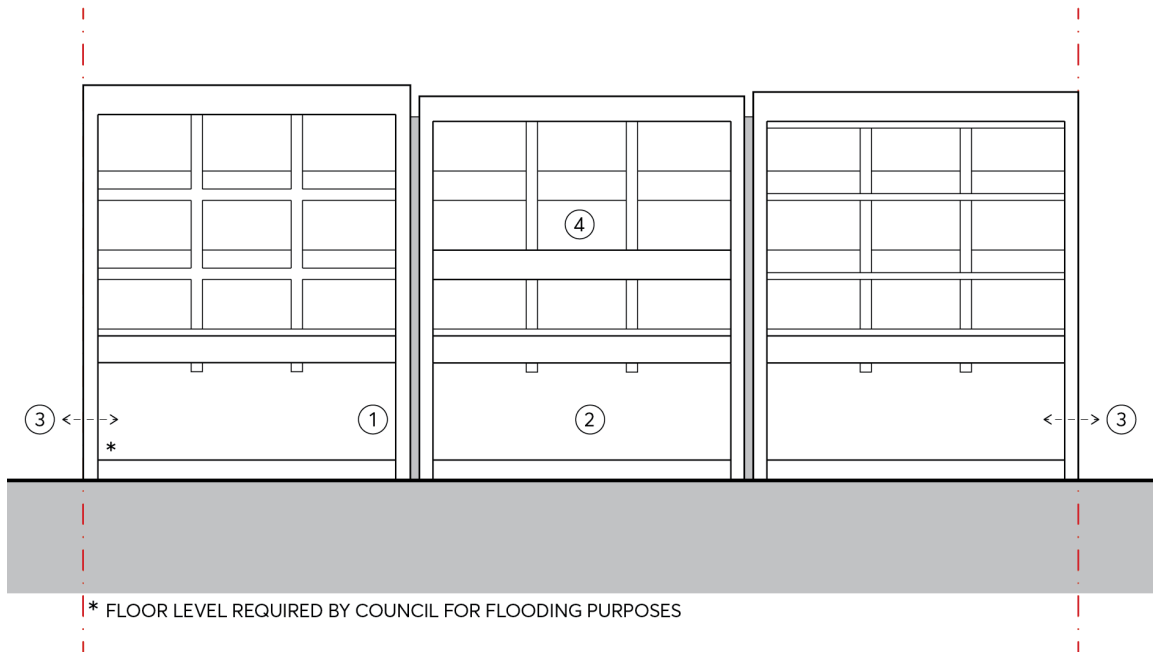

- ① GROUND LEVEL STRUCTURE ONLY AT MODULATION OF STREET WALL
- ③ POSSIBLE CONNECTION TO ADJACENT SITE
- ② ACTIVE FRONTAGE SET BACK, REFER TO SECTION 9A.3.5.1
- ④ DESIGN OF STREET WALL, REFER TO SECTION 9A.3.4

Figure 9.3.5.2.2 B – Active Ground Floor: Floor level required up to 1.5 metres above footpath level

C.03 Where integration with adjacent frontage is not possible or desirable, active frontage may be located on or close to the street boundary, subject to the maximum height of any wall being 0.9 metres. Refer to Figure 9.3.5.2.3 below.

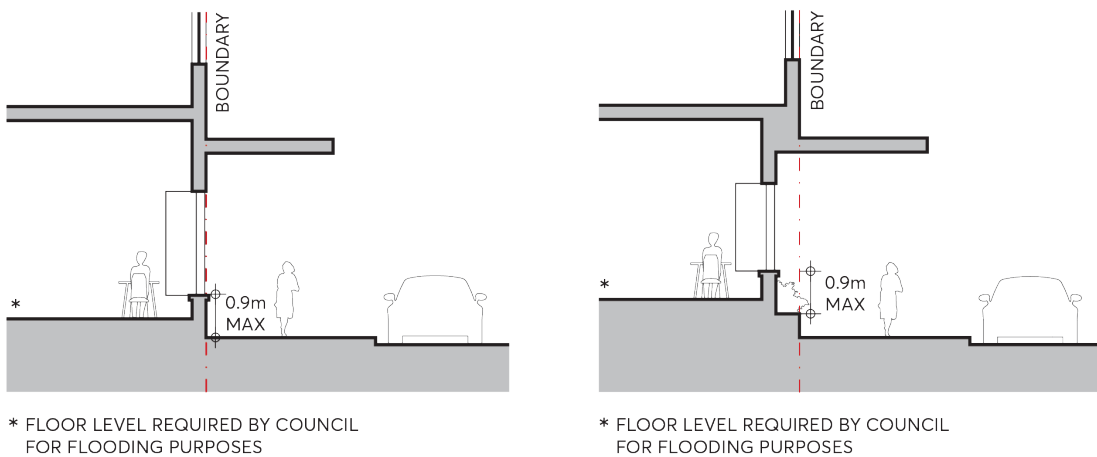

Figures 9.3.5.2.3 – Active Ground Floor: Frontage on or close to the street boundary

C.04 Where the floor level required by Council for flood protection is greater than 1.5 metres above footpath level, a raised frontage set back and adjacent to the footpath is unlikely to be practical, and the frontage may be activated with display windows, refer to Figures 9.3.5.2.4 below.

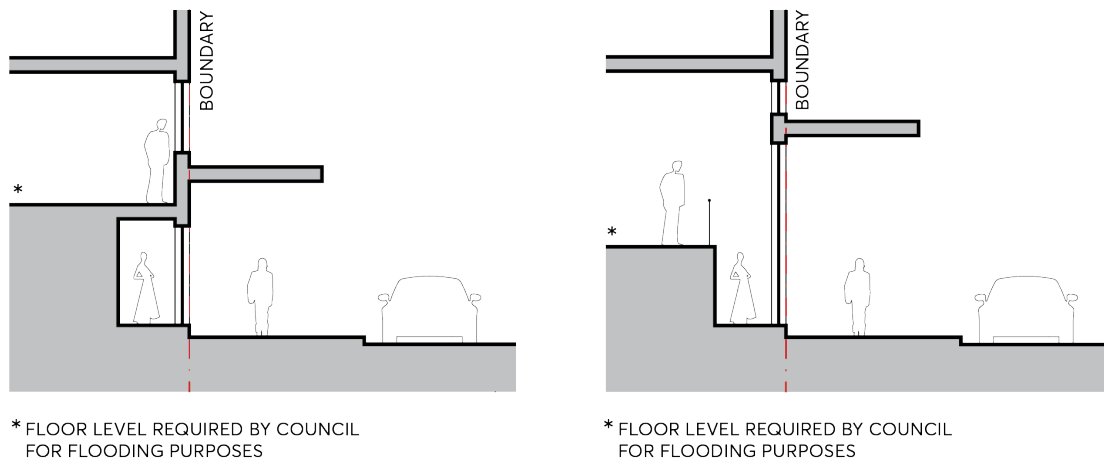

Figures 9.3.5.2.4 – Active Ground Floor: Floor level required greater than 1.5m above footpath level

9.3.5.2.2 RESIDENTIAL GROUND FLOOR FRONTAGE

Buildings with residential ground floors may be more easily able to incorporate the transition to the floor level required by Council for flood protection as they are set back from the street with deep soil landscape, and the desired spatial relationships at ground level are more suited to accommodate raised ground floors.

This section is correlated with the controls for residential ground floor frontage (Section 9.3.5.1.2 – Residential Ground Floor Frontage), adjusted as necessary for flooding constraints.

Controls

- C.01 Where the floor level required by Council for flood protection is 0.5-1.5 metres above footpath level the following parameters apply to the ground floor street frontage, refer to Figure 9.3.5.2.2.1.
- The building must be set back 6 metres from the street boundary. A 1 metre articulation zone is permitted forward of the setback, in which building elements may occupy a maximum of one third of the area of the facade. Services or lift shafts are not permitted in the articulation zone.
 - Basements must be set back a minimum of 5 metres from the street boundary measured to the outside face of structure to allow deep soil in the setback area.
 - The setback area must allocate the front 3 metres of the site adjacent to the footpath as common property for landscaping. Canopy trees must be planted in this area, a minimum 4.5 metres from the building facade, to achieve greater than 13 metres mature height and spread, at the rate of 1 canopy tree for every 15 lineal metres of frontage. Species selection and footing types must allow for optimum growing conditions as well as long term protection of any structures in the setback area.
 - A wall set back 3 metres from the street boundary must articulate the front areas in private ownership. The wall must be a maximum 1.2 metres high and of masonry construction only if acceptable to Council. If the street frontage is a significant overland flow path or

floodway Council may require the use of vegetation screening (hedges, shrubs) or open fences instead of solid walls as spatial separators.

- e) Where individual apartment entries from the street serve as a primary address, separation between the entry and private open space, and a front door with a distinct entry space within the apartment, must be provided. If the entries are only for the use of residents they must be understated, with post boxes and street numbers located at the common entry.
- f) All stairs and ramps providing access to lobbies must be internalised where necessary to ensure the street interface is not compromised.

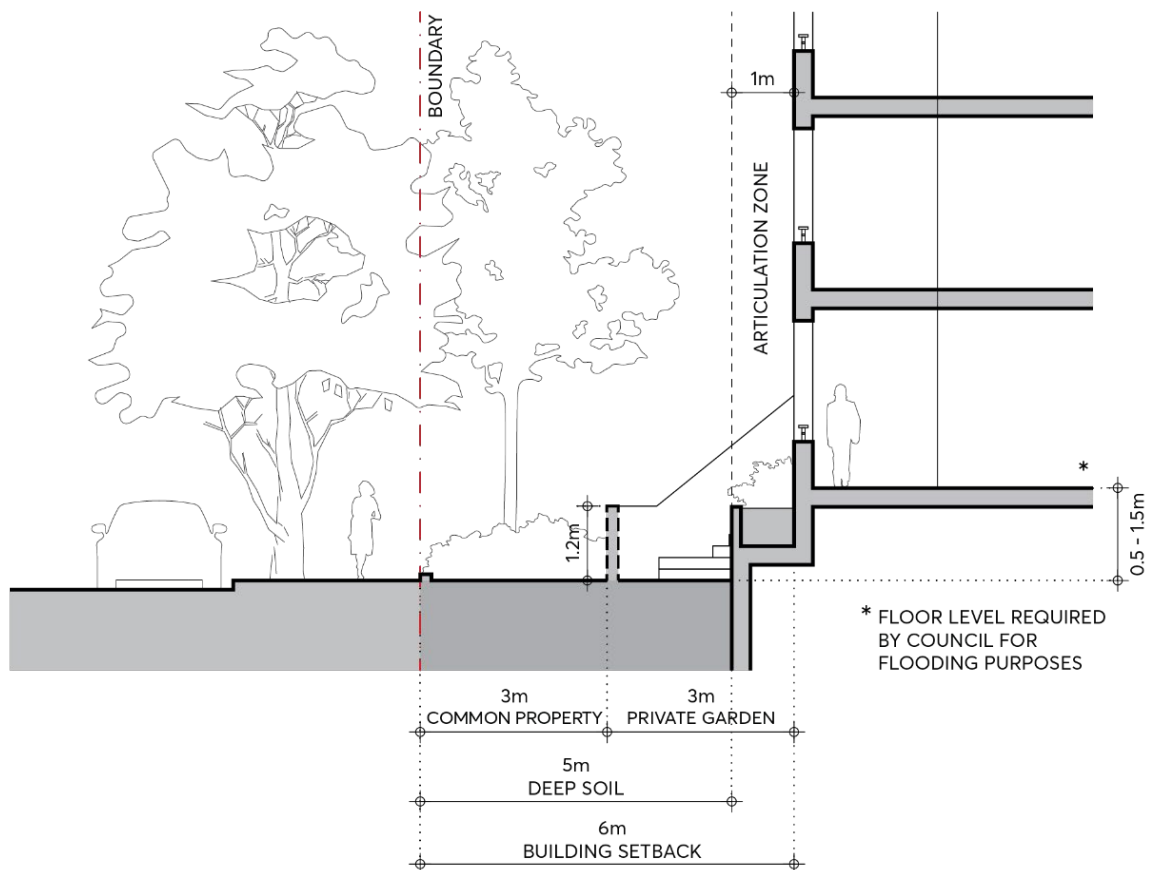

Figure 9.3.5.2.2.1 – Residential Ground Floor: Floor level required 0.5-1.5m above footpath level

C.02 Where the floor level required by Council for flood protection is greater than 1.5 metres above footpath level, the following parameters apply to the ground floor street frontage, refer to Figure 9.3.5.2.2.2:

- a) The building must be set back 6 metres from the street boundary. A 1 metre articulation zone is permitted forward of the setback, in which building elements may occupy a maximum of one third of the area of the facade. Services or lift shafts are not permitted in the articulation zone.
- b) Basements must be set back a minimum of 5 metres from the street boundary measured to the outside face of structure to allow deep soil in the setback area.

- c) The setback area of 6 metres must be in common property. Canopy trees must be planted in this area, a minimum 4.5 metres from the building facade, to achieve greater than 13 metres mature height and spread, at the rate of 1 canopy tree for every 15 lineal metres of frontage. Species selection and footing design must allow for optimum growing conditions as well as long term protection of any structures in the setback area.
- d) A wall at the boundary must define the street frontage. The wall must be a maximum of 1.2 metres high and of masonry construction only if acceptable to Council. If the street frontage is a significant overland flow path or floodway Council may require the use of vegetation screening (hedges, shrubs) or open fences instead of solid walls as spatial separators. If solid walls are permitted, recesses in the wall of maximum 1.5 metres deep may be set in from the boundary at intervals to relieve its length.

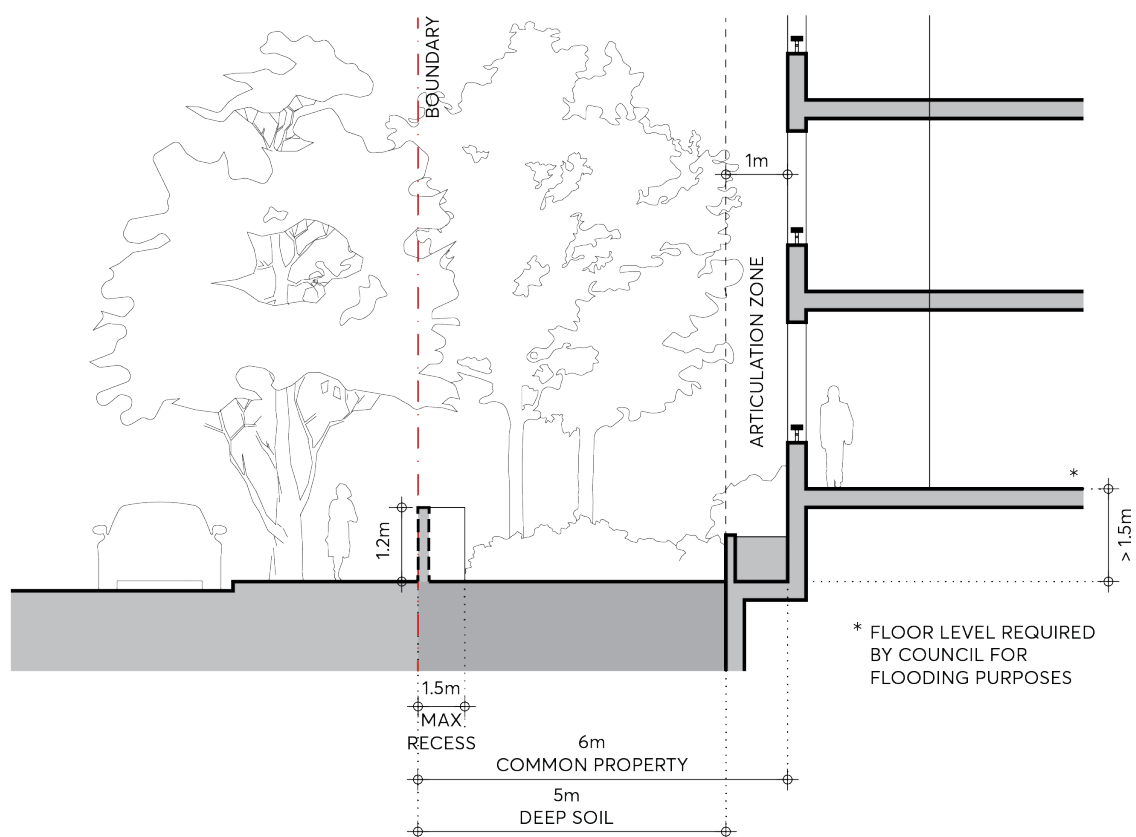

Figure 9.3.5.2.2.2 – Residential Ground Floor: Floor level required greater than 1.5 metres above footpath level

- C.03 A fully illustrated and co-ordinated ground floor design, showing all the necessary levels and detail, must accompany development applications. Drawings must include the following:
- A detail ground level plan and sections as part of the architectural submission which illustrates the relationships between the interior and the exterior spaces of the setback area, including the landscape and hydraulic detail, and extends into the public domain.
 - Any required services must be discreetly integrated into the frontage design.
 - The architectural drawings must be fully co-ordinated with the landscape and hydraulic drawings.

- d) Elevations and sections at minimum 1:50 scale of all built elements in the setback area must be provided.

9.3.5.2.3 FLOODWATER MANAGEMENT DESIGN ELEMENTS

Council may require flood waters to be transmitted around or within the development site on the surface. Generally, Council will not permit floodwaters to be directed through or beneath buildings, including undercrofts, either for floodway conveyance or flood storage. Undercrofts, underfloor flow areas and similar structures are not supported.

Objectives

- O.01 Design the site layout and buildings to permit the flow of flood water on the surface around and possibly through development sites between substantial buildings and along streets where this is appropriate, safe and is a legitimate response to flood advice from Council.
- O.02 Minimise negative impacts of flood management design elements on public safety, built form and the public domain.
- O.03 Do not use unsafe and unmanageable design elements such as undercrofts, sub floor flow paths, tunnels, plenums and the like.
- O.04 Flood design and management must include allowance for water-borne debris as well as floodwaters. This includes providing substantial vertical clearance and space to the sky above flow paths.

Controls

- C.01 A clear flow path of water must be provided to the satisfaction of Council's flood engineers.
- C.02 The design of the flood conveyance area must incorporate high quality, durable, flood resilient and low maintenance materials to enhance the visual appearance of the built form edge.
- C.03 Plants and landscape must be resilient to flooding, facilitate water permeability and have the ability to withstand temporary inundation. There may be some exceptional circumstances where infrequent but intense flooding is experienced and some planting may be intentionally designed to not withstand such extreme events. Liaise with Council to ensure planting and landscape design is appropriate for the flooding environment of the specifics of the site.
- C.04 Building details must be designed not to gather rubbish, debris nor provide breeding grounds for vermin and weeds.
- C.05 Flood management design elements must observe crime prevention through environmental design (CPTED) principles of natural surveillance, upkeep, ownership and territoriality.
- C.06 Active and residential ground floor premises affected by flooding must be designed to respond to the flood risk environment and to the safety of occupants and the public as required by Council for the site in question. Such premises must provide ground floor layouts that maintain an attractive street address which promotes engagement with and casual surveillance of the street without unnecessary domination by hydraulic infrastructure.

9.3.5.3 ARCADES

Objectives

- O.01 Improve pedestrian connectivity where appropriate.
- O.02 Increase frontage for retail activity.
- O.03 Expand the extent and variety of the pedestrian network.

Controls

- C.01 Arcades must be located in a mid-block position or where connections can be made between other public spaces as agreed with Council.
- C.02 Arcades must not compromise or take precedence over the activation of adjacent streets.
- C.03 Where possible, arcades must be aligned with existing arcades or laneways across blocks.
- C.04 Arcades must provide clear access and sight lines from one end to the other and be designed so as to:
 - a) Be well-proportioned with a minimum width of 4 metres and minimum ceiling height of 4 metres.
 - b) Have a 1:20 maximum gradient.
 - c) Connect one public space to another in a clear and obvious way.
 - d) Act as a supplementary connection rather than a primary one.
 - e) Conform to the relevant controls relating to active ground floor frontage in 9.3.5.1.1 – Active Ground Floor Frontage.
- C.05 Arcades must be publicly accessible 24 hours per day unless otherwise established during the Development Application assessment.

9.3.5.4 SERVICES AND UTILITIES

The location of utilities and services can adversely affect the ground floor street frontage if not properly taken account of in the initial design stage. It is also essential that building services are located and designed to be free from flooding impacts. This may require innovative solutions and consultation with utility and service providers, particularly for single frontage sites.

Objectives

- O.01 Minimise the extent of space and blank walls occupied by services, including electricity substations, fire boosters, fire doors, plant and equipment hatches.
- O.02 Ensure services and utilities allow for maximum activation of the ground floor.

- O.03 Locate building services to be free from flooding impacts.
- O.04 Encourage innovative design and location solutions for services and utilities that minimise adverse visual, environmental and access impacts.

Controls

- C.01 The location of all services and utilities must be clearly identified on plans prepared for any Design Competition, pre-lodgement application and development application.
- C.02 Wherever possible, services and utilities must be located on secondary street frontages, laneways or non-active street frontages. Substations in particular should be located at the first floor, or in a basement, whenever possible.
- C.03 Services and utilities must be designed and located so as to minimise the length of ground floor frontage occupied.
- C.04 Development applications must be accompanied by evidence that the relevant electricity provider has been consulted in relation to the location of the electricity substation.
- C.05 Where a site has a single frontage, documentation must illustrate consideration of the substation in a location that does not occupy ground floor frontage, and which satisfies the access, security, drainage and ventilation requirements of the electricity provider and any flood constraints on the site.
- C.06 Where adjoining sites are being concurrently developed, documentation must be submitted outlining the service and utilities needs for both sites and a proposal for how shared service and utilities can be accommodated.
- C.07 In flood affected sites, electricity substations must be located above the Flood Planning Level (Ausgrid NS185 Major Substations Building Design Standard), and suitable access and clearance for maintenance must be provided.

9.3.6 ABOVE GROUND PARKING

Objectives

- O.01 Ensure that above ground car parking is of high quality design that integrates with the building and does not adversely impact the public domain.
- O.02 Ensure that above ground parking facades are consistent with the character of the street walls as set out in Section 9.3.4 – The Street Wall.
- O.03 Promote active uses and casual surveillance on street and lane frontages.
- O.04 Design above ground car parking that is able to be adapted to alternate uses over time.

Controls

- C.01 The preferred location of car parking in the City Centre is basement car parking. Where there are identified constraints such as archaeological conditions or where a driveway crest to the

Flood Planning Level is not practically achievable, car parking above ground may be appropriate in accordance with design controls in this section as well as Section 9.7 – Flood Risk Management.

C.02 Where Council is satisfied that above ground parking is justified:

- a) On streets, all parking must be sleeved with permitted uses: active or residential frontage on the ground level, and commercial or residential frontage on the first floor and above.
- b) On lanes, parking is generally not required to be fully sleeved. Depending on site circumstances and context, activation or partial activation of the ground level frontage may be required by Council, and partial sleeving of upper levels to provide casual surveillance may be required.
- c) On lane corner sites, the ground floor active street frontage must wrap around the corner into the lane frontage.

C.03 Where above ground parking is included in any building, the following controls apply:

- a) Where non-sleeved parking is permitted or unavoidable, the street wall must nonetheless comply with the controls in 9.4.4 – The Street Wall. Green walls, screens and the like must not be used as an applied cover that masks the architectural attributes of the street wall facade. Greenery may be incorporated in the street wall so as to complement its required character as set out in 9.4.4 – The Street Wall.
- b) Cars and car parking luminaires must not be visible from the public domain or nearby buildings.
- c) If car parking is located on a roof top, it must not be visible from the sky or other buildings.
- d) Above ground car parking must be set back from a rear boundary of the site by a minimum of 6 metres to allow for natural make up air supply to ensure efficient low energy operation.
- e) Proposals must demonstrate how the layout and floor to ceiling height of above ground car parking can be adapted in the future for alternative uses.

9.3.7 RESIDENTIAL APARTMENT DESIGN QUALITY

Objectives

- O.01 Ensure development achieves good amenity standards for residents in relation to daylight, ventilation, outlook and privacy.

Controls

- C.01 Building indentations providing light and ventilation to single aspect apartments must have a minimum width to depth ratio of 2:1.
- C.02 High level windows must not be used as the primary source of light, ventilation and outlook for habitable rooms.
- C.03 Daylight and natural ventilation must be provided to all common circulation spaces and windows must be visible from lift cores as well as the ends of corridors.

- C.04 Only cross-over, cross-through or corner apartments can be counted as naturally cross ventilated. Indentations in the facade cannot be used to classify adjacent apartments as naturally cross ventilated, nor can 2 storey single aspect apartments be counted as naturally cross ventilated.
- C.05 Walls between apartment balconies must be of solid construction and extend from floor to ceiling.
- C.06 Balustrades must take account of sightlines to balance the need for privacy within apartments and views out of apartments. A proportion of solid or translucent material must be used, which will vary according to outlook and height relationships.

9.3.8 WINTERGARDENS

Objectives

- O.01 Improve amenity of balconies in high rise apartments and apartments fronting noisy environments such as busy roads or railway lines.
- O.02 Provide acoustic attenuation for internal living areas.
- O.03 Balance ventilation and wind impacts in high rise apartment balconies.
- O.04 Maximise daylight access, views and comfort of balconies.

Controls

- C.01 Wintergardens must be designed and constructed as a private external balcony with drainage, natural ventilation and finishes acceptable to an outdoor space and must not be treated as a conditioned space or weatherproof space.
- C.02 Effective natural ventilation must be provided as follows:
 - a) Not less than 80 per cent of the external wintergarden perimeter must be fully operable glass louvres.
 - b) If fixed glazing is proposed, permanent openings must be provided for an area not less than 15 per cent of the greater of the enclosed wintergarden floor area or external wintergarden facade area. 30-50 per cent of the fixed opening area must be provided in a zone within 500mm of the floor and the remainder within 500mm of the soffit.
 - c) Casement or awning windows are not permitted.
- C.03 A generous opening must be provided between the wintergarden and any adjacent living area to allow connection of the spaces when ambient conditions are suitable.
- C.04 Acoustic control for living areas and bedrooms must be provided on the internal facade line between the wintergarden and the living area or bedroom.
- C.05 Glazing in the external facade of a wintergarden must have a solar absorption of less than 10 per cent.

- C.06 The flooring of the wintergarden must be a drained impervious finish and provide exposed thermal mass.
- C.07 No heat rejection source from any heating, ventilation and cooling systems are permitted to be located in a wintergarden.

9.3.9 DWELLING MIX AND FLEXIBLE HOUSING

Objectives

- O.01 Ensure a range of dwelling types and size.
- O.02 Promote the design of buildings that are adaptable and incorporate flexible apartments to suit the changing lifecycle housing needs of residents over time.

Controls

- C.01 The following dwelling mix is to be used as a guide for mixed use and high density residential development:

Dwelling Type	Dwelling Mix
Studio / 1 Bedroom	10 - 20% of total dwellings
2 Bedroom	55 - 70% of total dwellings
3 Bedrooms	10 - 20% of total dwellings
4 Bedrooms	5 - 10% of total dwellings

- C.02 Apartments may be configured as 'dual key' apartments provided that:
- Where a strata plan exists, both apartments are contained within a single strata unit.
 - A maximum 10 per cent of apartments can be dual key apartments.
 - The primary and secondary units are accessed from a shared private lobby.
 - The minimum ADG requirements for internal space are met for each individual unit within the dual key apartment.
 - The secondary unit of the dual key apartment has either shared access to the primary unit's private open space or its own private open space of dimensions commensurate with Apartment Design Guide requirements.
 - The provision of car parking spaces for dual key units is as per the *Parramatta LEP 2023* controls.
 - Internal layouts allow for apartments that are adaptable over time to accommodate varied living arrangements with the use of moveable internal walls and considered location of services.

9.4 PUBLIC DOMAIN

Figure 9.4.1 indicates the existing and intended future Public Domain of the Parramatta City Centre together with relevant surrounding places.

Public spaces – streets, squares and parks – are the most enduring spaces of the city, the shared social and cultural domain that make up the organising framework of the City. Their clarity, quality and amenity contribute in a fundamental way to the identity and experience of the city.

This section details aspects of the design of the public domain, and must be read in conjunction with the [Public Domain Guidelines](#), which sets out the process, design guidelines and submission requirements for all new public domain assets in the City of Parramatta.

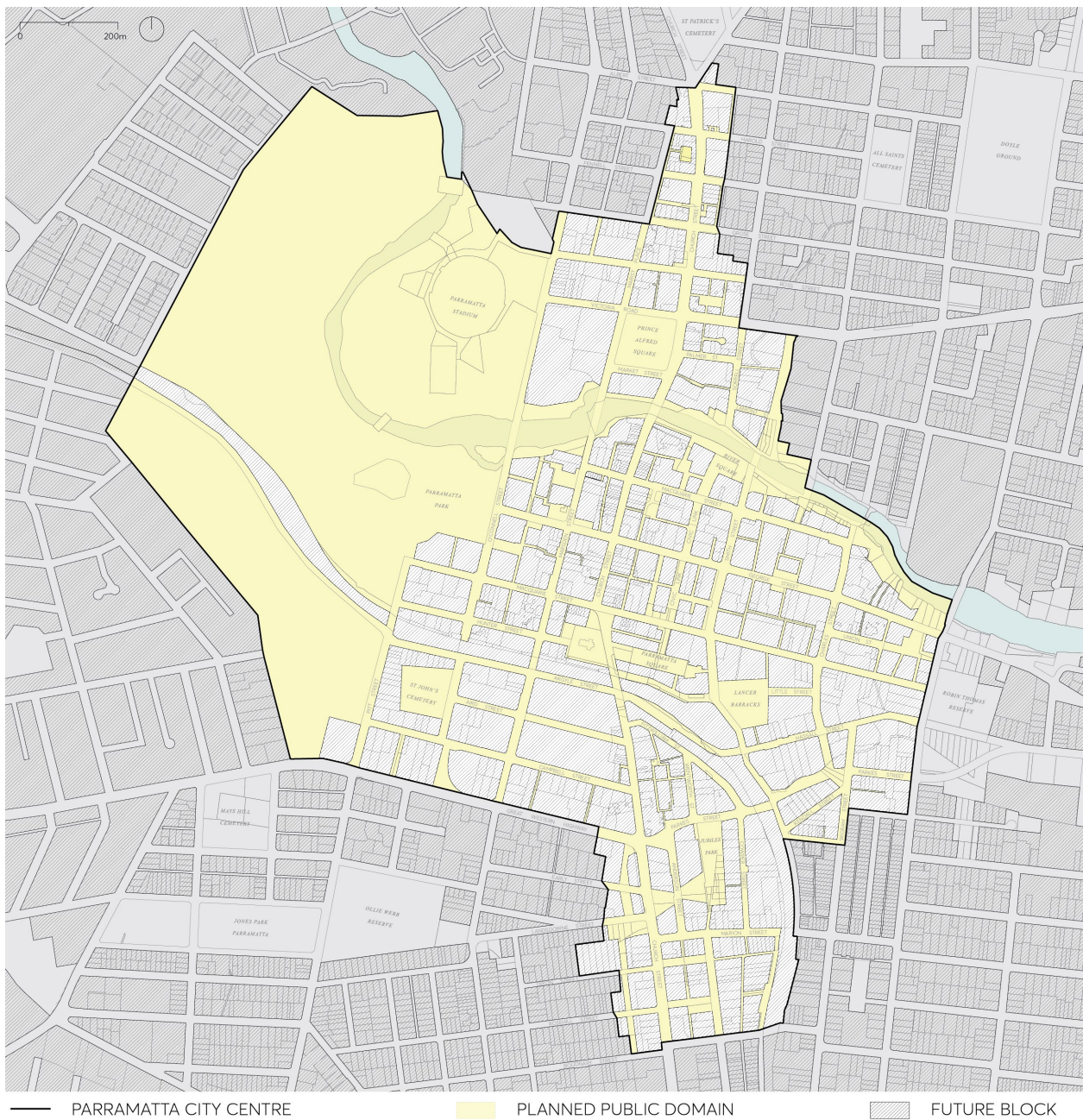

Figure 9.4.1 – The Public Domain

9.4.1 SOLAR ACCESS TO SIGNIFICANT PARKS AND SPACES

Good solar access is an important contributor to the amenity of public spaces. Maintaining sunlight to significant public spaces within and close to the perimeter of the Parramatta City Centre will provide benefit to existing and future residents, workers, and visitors. The provision of solar access throughout the year is essential for a successful public open space. In addition, sunlight is crucial for the establishment and sustained health of tree planting and vegetation which provides attractive and cool environments for people in the City Centre.

The *Parramatta LEP 2023* provides specific solar access controls for Parramatta Square, Lancer Barracks, the River Foreshore and Jubilee Park. Additional parks and spaces within and close to the perimeter of the Parramatta City Centre have been identified in Figure 9.4.1.1 as providing valuable opportunities to maintain and enhance solar access.

Objectives

- O.01 Maintain or maximise solar access to the significant parks and spaces in and around the Parramatta City Centre during periods in the day when they are most used throughout the year.
- O.02 Maintain or maximise solar access to spaces which have important recreation values, aesthetic qualities and or heritage significance.
- O.03 Maintain or maximise solar access to existing spaces which may contribute to the open space network in the future.
- O.04 Promote active and passive recreation to public spaces to service existing and planned population of the Parramatta City Centre and surrounds.
- O.05 Ensure the successful growth and survival of trees and vegetation within these parks and spaces.

Controls

- C.01 New development, or additions and alterations to existing buildings, must not create any overshadowing to areas marked 'no overshadowing' in all Figures referenced in Column 2 of Table 9.4.4.1, between the nominated times listed in Column 3 of Table 9.4.4.1. Contact Council to source CAD files of areas identified for 'no overshadowing'.
- C.02 Where overshadowing of parks and spaces identified in Figure 9.4.1.1 is likely, a statement with supporting solar access studies must be submitted by a registered architect demonstrating that the proposed development does not overshadow the affected open space consistent with all Figures referenced in Column 2 of Table 9.4.4.1.
- C.03 New development and additions or alterations to existing buildings are to comply with the solar access controls irrespective of the existing height of nearby buildings.
- C.04 Ancillary structures such as columns, pillars, spires, flag poles, public art, and architectural roof features including equipment for servicing the building, such as plant, lift motor rooms, fire stairs and the like, must not be excluded from any overshadowing analysis.

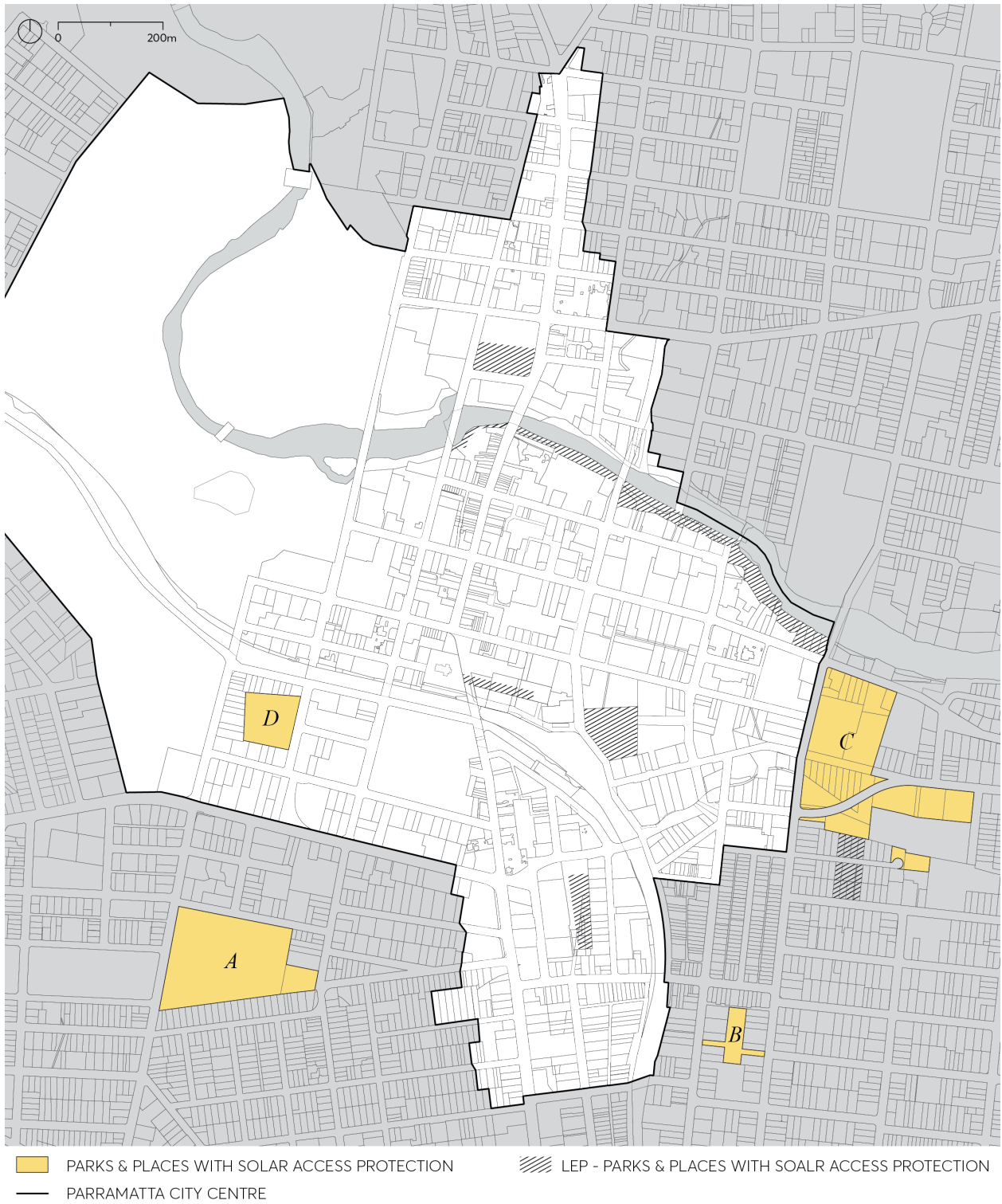

Figure 9.4.1.1 – Parks and Places with Solar Access Protection

Table 9.4.1.1 – Nominated Significant Parks and Spaces and times for solar access protection

Column 1: Significant Park or Space	Column 2: Figure reference	Column 3: Nominated Time
A. Ollie Webb Reserve	Figure 9.4.1.2	10am to 12 midday mid-winter 21 st June
	Figure 9.4.1.3	12 midday to 2pm mid-winter 21 st June
B. Rosella Park	Figure 9.4.1.4	10am to 12midday mid-winter 21 st June
	Figure 9.4.1.5	12 midday to 2pm mid-winter 21 st June
C. Robin Thomas and James Ruse Reserve	Figure 9.4.1.6	10am to 12 midday mid-winter 21 st June
	Figure 9.4.1.7	12 midday to 2pm mid-winter 21 st June
D. St John's Cemetery	Figure 9.4.1.8	10am to 12 midday mid-winter 21 st June
	Figure 9.4.1.9	12 midday to 2pm mid-winter 21 st June

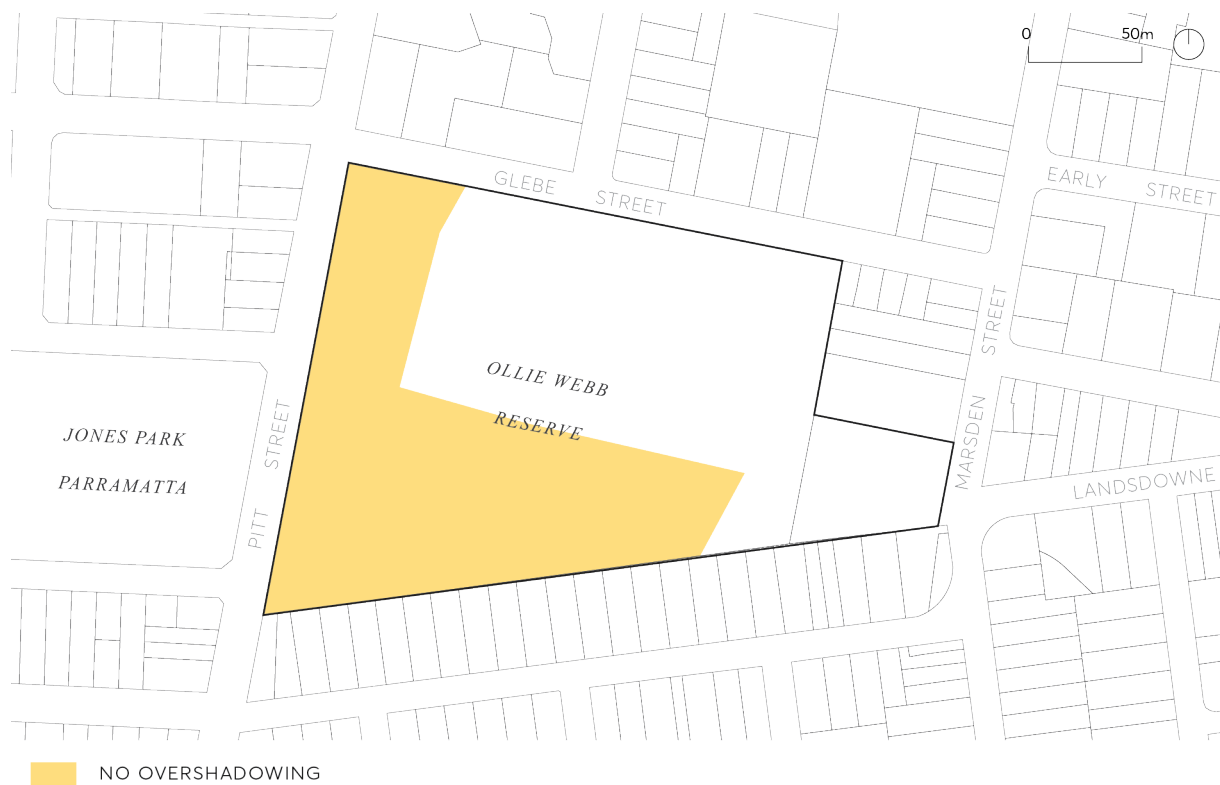

Figure 9.4.1.2 – Ollie Webb Reserve area of no overshadowing between 10am and 12pm mid-winter 21st June

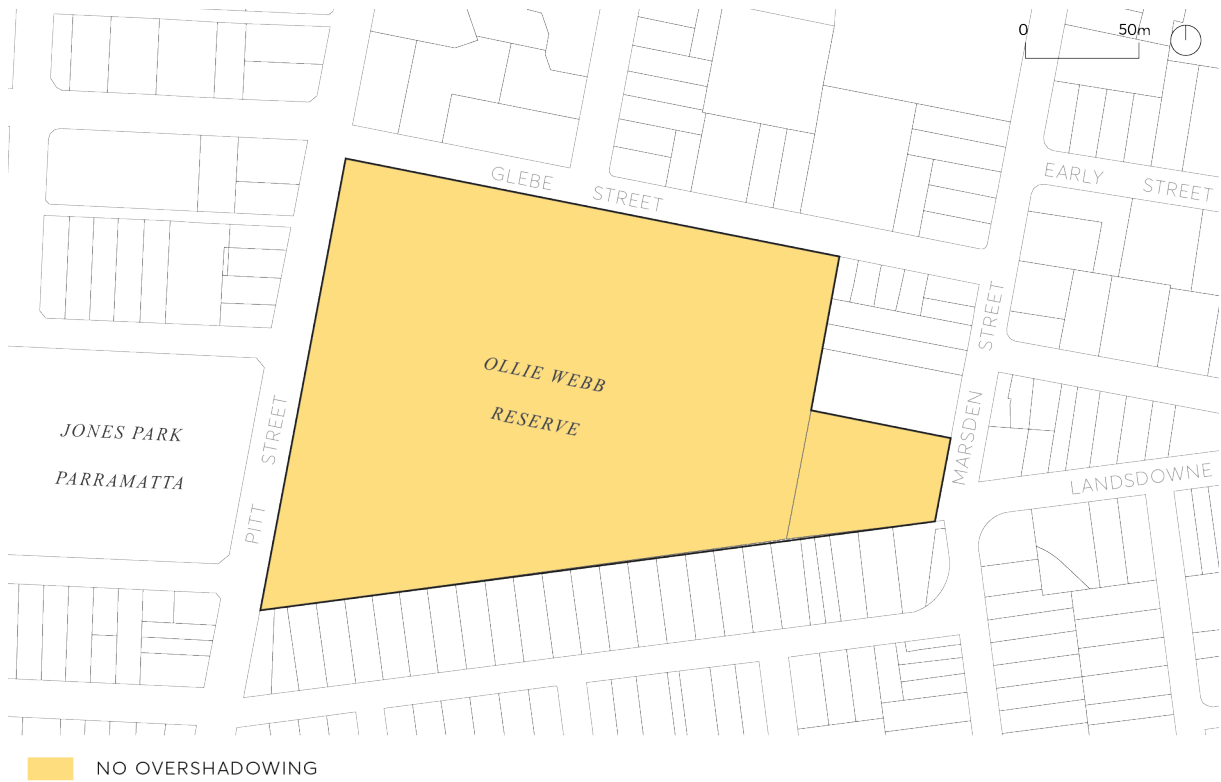

Figure 9.4.1.3 – Ollie Webb Reserve area of no overshadowing between 12pm and 2pm mid-winter 21st June



Figure 9.4.1.4 – Rosella Park area of no overshadowing between 10am and 12pm mid-winter 21st June

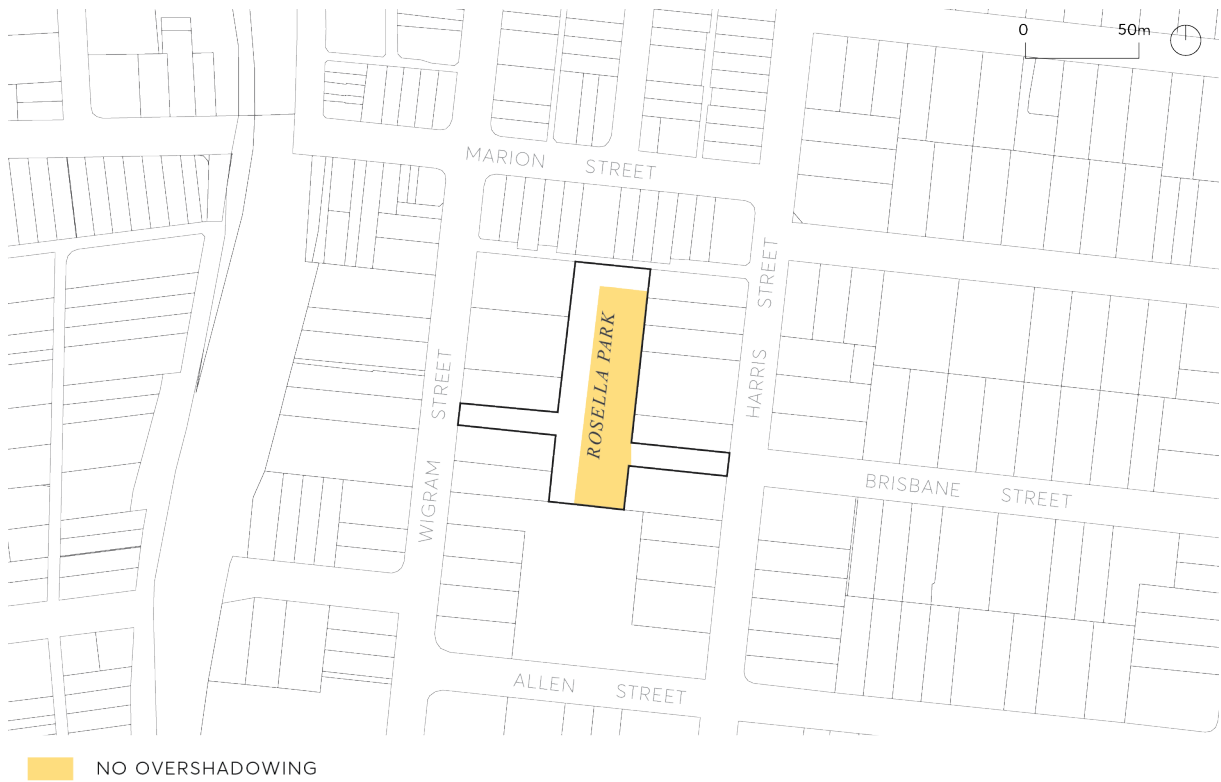

Figure 9.4.1.5 – Rosella Park area of no overshadowing between 12pm and 2pm mid-winter 21st June



Figure 9.4.1.6 – Robin Thomas Reserve area of no overshadowing between 10am and 12pm mid-winter 21st June



Figure 9.4.1.7 – Robin Thomas Reserve area of no overshadowing between 12pm and 2pm mid-winter 21st June

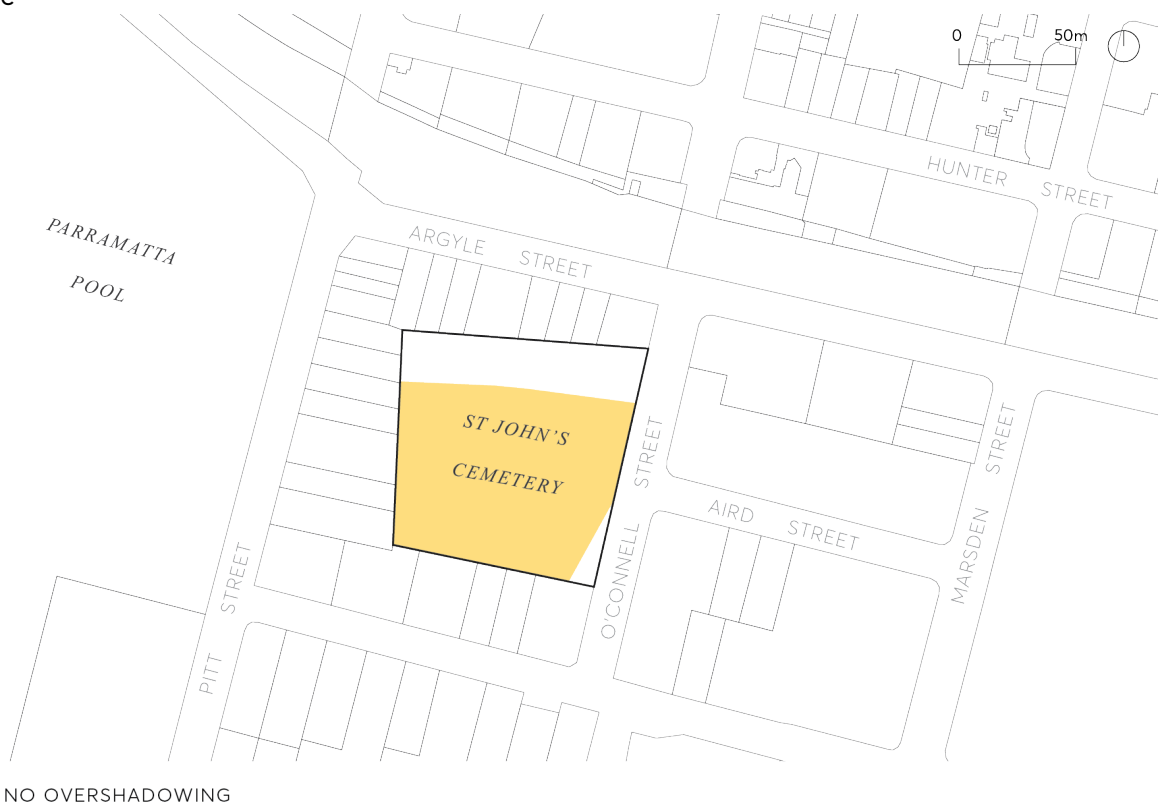

Figure 9.4.1.8 – St Johns Cemetery area of no overshadowing between 10am and 12pm mid-winter 21st June

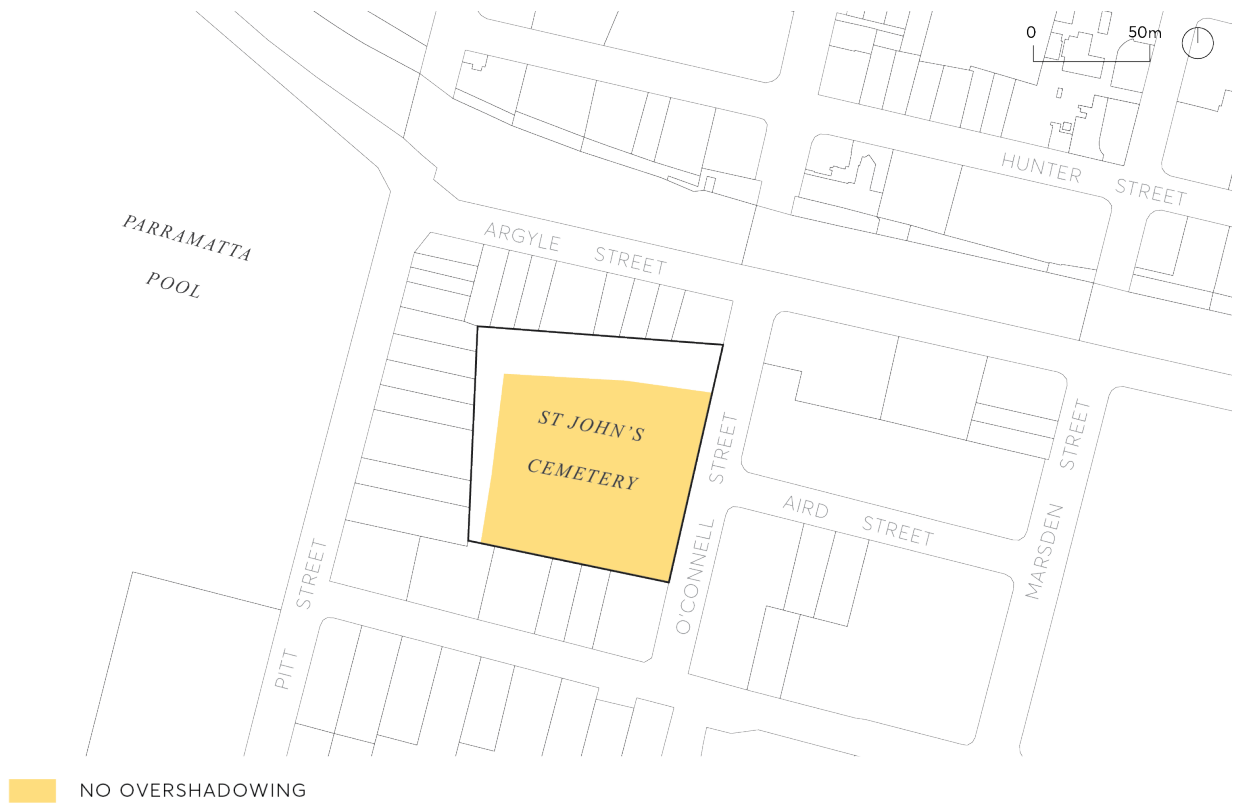

Figure 9.4.1.9 – St Johns Cemetery area of no overshadowing between 12pm and 2pm mid-winter 21st June

9.4.2 AWNINGS AND TREES ON STREETS

Awnings encourage pedestrian activity along streets by providing comfortable conditions at footpath level and, in conjunction with active ground floor frontages, contribute to the vitality of the streets. Awnings are the favoured means to provide shelter and weather protection for pedestrians. Colonnades are generally not supported as they restrict views of the frontage and fragment the public domain.

Trees are essential for their contribution to the amenity and character of the City Centre. When properly selected, located, planted and maintained street trees provide a multitude of benefits to the urban environment.

Ideally, in streets with active ground floor frontages, footpaths in the City Centre would be wide enough for awnings as well as street trees, but public footpath widths are generally 3.6 – 3.9 metres, and mostly insufficient to adequately accommodate both. Consequently, the following sections nominate controls for those streets where awnings have priority, those where trees have priority, and a possible strategy to achieve both awnings and trees where circumstances permit.

9.4.2.1 AWNINGS HAVE PRIORITY

Objectives

- O.01 Ensure increased amenity in areas of high pedestrian volume by providing continuous protection from rain, sun and wind down draft.

Controls

- C.01 Continuous awnings must be provided along streets where identified in Figure 9.4.2.1.1.
- C.02 Dimensions of awnings must be in accordance with Figure 9.4.2.1.2.

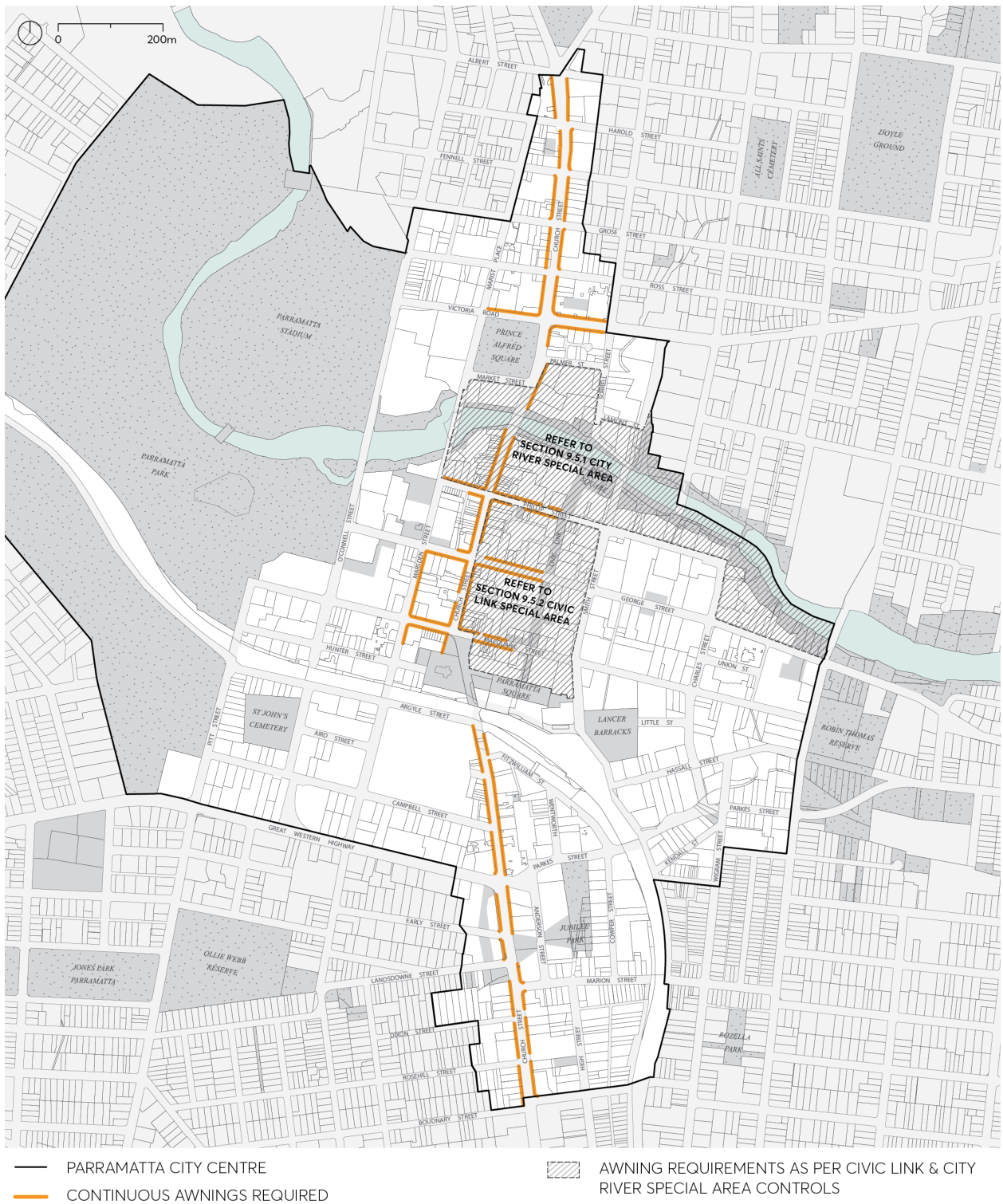

Figure 9.4.2.1 – Awnings have priority – Continuous awnings

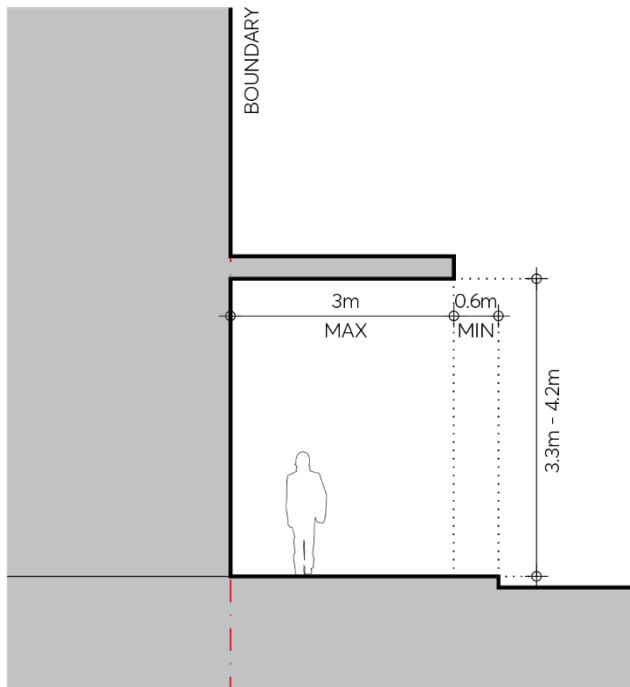

Figure 9.4.2.1.2 – Awnings have priority – Dimensions of awnings

9.4.2.2 STREET TREES HAVE PRIORITY

In those areas where trees have priority, awnings of reduced width may be provided where footpaths are of sufficient width.

[Parramatta Public Domain Guidelines](#) identify the location of street trees and species selection and should be consulted when proposing the delivery of street trees as part of any development.

Objectives

- O.01 Maintain existing street trees and plant additional street trees within the public domain.
- O.02 Improve and enhance environmental biodiversity and mitigate temperature at ground level.
- O.03 Ensure maximum street tree crown development and performance.
- O.04 Improve visual amenity of the public domain.
- O.05 Improve quality of view for residents, workers and others overlooking the public domain.

Controls

- C.01 Street trees must be provided along those streets identified in Figure 9.4.2.2.1.
- C.02 Where footpath widths are 3.9 metres or greater, narrow width awnings may also be provided in accordance with Figure 9.4.2.2.2.
- C.03 Street tree species and spacing must be as specified in the [Parramatta Public Domain Guidelines](#).

- C.04 Street trees must be installed in accordance with the [Parramatta Public Domain Guidelines](#) and Council Design Standards.
- C.05 A Public Domain Alignment Plan indicating the street tree locations as detailed in the [Parramatta Public Domain Guidelines](#) must be submitted for the Development Application and Construction Certificate Application.

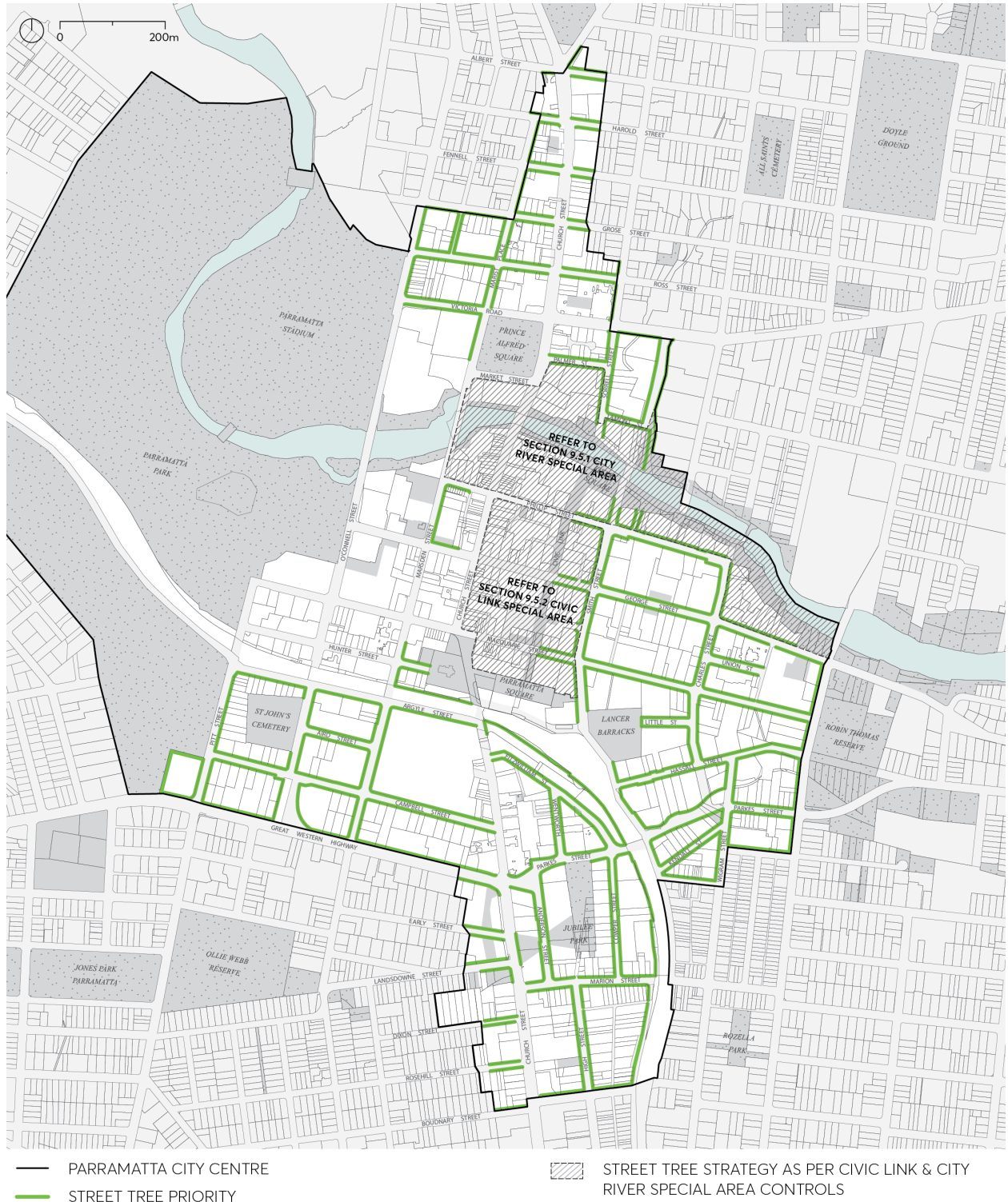

Figure 9.4.2.2.1 – Street trees have priority

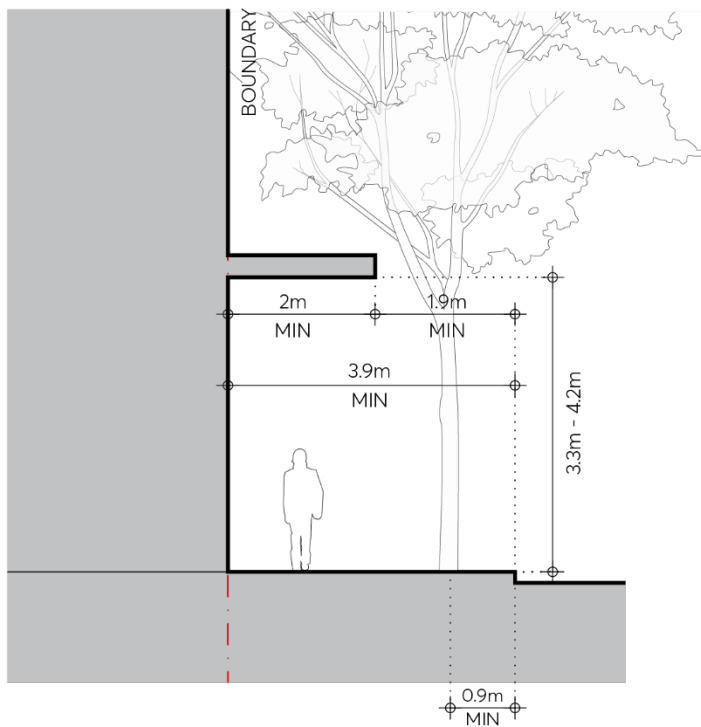

Figure 9.4.2.2.2 – Street Trees have priority, narrow width awnings

9.4.2.3 SEMI-RECESSED AWNINGS

Semi-recessed awnings are an option for consideration either where awnings or street trees have priority. Setting the ground floor frontage back from the boundary and integrating the awning with the building soffit above can provide a generous footpath width, good awning cover as well as the necessary space for street trees.

Existing and possible future adjacent context must be taken into account in determining whether this option is feasible in each situation. Applicants should contact Council at the start of the design process to establish the street and awning profile for the proposal.

Objectives

- O.01 Allow for the possibility of generous footpaths, shelter from awnings as well as street trees where circumstances permit.

Controls

- C.01 Semi-recessed awnings may be provided in accordance with Figure 9.4.2.3.1.
- C.02 Where a semi-recessed awning is proposed, the following must be incorporated in its design:
- The awning must be integrated with the building soffit above as shown in Figure 9.4.2.3.1.
 - The space under the semi-recessed awning must be free of columns.
 - The frontage must be integrated with the adjacent existing frontage.

- d) A clear path of travel must be provided in the public domain as defined in the [Parramatta Public Domain Guidelines](#).

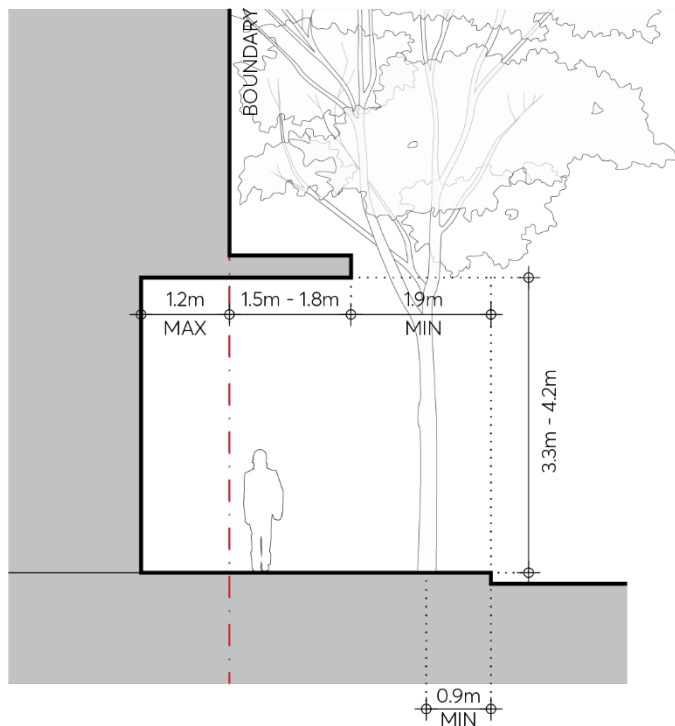

Figure 9.4.2.3.1 – Semi-Recessed Awnings

9.4.3 DESIGN OF AWNINGS

Well designed awnings provide a sheltered, humanly scaled space on the footpath that creates an accommodating pedestrian environment for shopping, dining, walking and lingering. They also provide weather protection for the doorways, openings and display areas of the active ground floor frontage of the building.

As an architectural element that is both part of the building as well as the public space of the street, the awning must integrate both with the characteristics of the building as well as existing and possible future adjacent awnings.

9.4.3.1 AWNINGS ON STREETS

Objectives

- O.01 Design awnings to provide protection from rain, sun and wind down draft.
- O.02 Maintain complementary architectural detail of awning design.

Controls

- C.01 Awning dimensions must be in accordance with Figures 9.4.2.1.2, 9.4.2.2.2 and 9.4.2.3.1.

- C.02 Double height awnings are not permitted.
- C.03 All awnings and shading devices must have non-reflective surfaces.
Note – Non-reflective surfaces is defined in Section 9.8.5 – Urban Cooling.
- C.04 Glazed awnings are not permitted except for minor articulation purposes.
- C.05 New awnings must be designed to take account of adjacent existing awnings.
- C.06 The awning roof must be designed so that all gutters are concealed and downpipes incorporated in the building fabric.
- C.07 Lighting and other fixtures must be recessed and integrated into the design of the soffit.
- C.08 Where street trees are provided, the entire length of the awning must be set back from the kerb as shown on Figures 9.4.2.2.2 and 9.4.2.3.1. Cut outs for trees and light poles in awnings are not permitted.
- C.09 The conversion of awnings to verandahs or balconies is not permitted.
- C.10 Where a proposed building is located on a street corner and an awning is not required on one frontage, the awning must extend around the corner by a minimum of 6m from the boundary corner.

9.4.3.2 AWNINGS ON LANES

Objectives

- O.01 Encourage well-designed entrance canopies in order to provide additional shelter in lanes.
- O.02 Ensure that individual entry points are defined and address the lane.

Controls

- C.01 Continuous awnings are not permitted in lanes.
- C.02 Entrance canopies must not be supported with posts in order to maintain sight lines and a clear path of travel along the building edge, in accordance with the [Parramatta Public Domain Guidelines](#) 2017.
- C.03 Fixed awnings must not obstruct traffic.
- C.04 Retractable awnings must be a folding arm type and that extends into the lane no more than footpath width, in accordance with the [Parramatta Public Domain Guidelines](#).
- C.05 Provide individual awnings at building entries that are visually attractive.

9.4.4 PEDESTRIAN LANES, SHARED ZONES AND SERVICE LANES

Many street blocks within the Parramatta City Centre are long, some being over 250 metres in an east-west direction and over 140 metres in a north-south direction. The benefits of a finer network of lanes are numerous: greater connectivity, increased frontage for entries and business opportunities, and a spatial intimacy and variety in the public domain. Service lanes also assist with activation of primary street frontages by providing back of house vehicular access, thereby reducing the necessity for driveways disrupting major city footpaths.

Pedestrian lanes are non-trafficable and can be narrower in width than those with vehicular access. Shared lanes have pedestrian priority over vehicle movement and typically have a flush surface for the full width of the lane. Service lanes prioritise vehicle movement and separate pedestrian movement by the use of kerbs or barriers. Service lanes should also be preserved from residential encroachment to ensure servicing is maintained or improved.

Council's City Centre Lane Policy and [Parramatta Public Domain Guidelines](#) provide further guidance on the design of pedestrian lanes, service lanes and shared zones.

Objectives

- O.01 Retain and increase connectivity in the public domain and variety in the street network.
- O.02 Encourage vehicular entries from shared zones and service lanes and not primary street frontages.
- O.03 Design lanes, shared zones and service lanes to encourage pedestrian amenity and safety.
- O.04 Encourage active frontages along lanes, shared zones, and service lanes without compromising safe pedestrian access and use.
- O.05 Ensure that any proposed privately owned lanes have a fully public nature equivalent to the public domain.

Controls

- C.01 A development must fully or partially deliver a pedestrian lane, service lane or shared zone as shown in Figure 9.4.4.1 Existing and Required lanes in the Parramatta City Centre
- C.02 Any development that proposes a new pedestrian lane, shared zone or service lane in addition to those indicated in Figure 9.4.4.1 must demonstrate that it meets the objectives and controls of this section.
- C.03 The minimum width of a pedestrian lane must be 4 metres as measured from the property boundaries.
- C.04 The minimum width of a shared zone or service lane must be 6.5 metres as measured from the property boundaries.
- C.05 The design and finish of pedestrian lanes, shared zones or service lanes must be in accordance with the [Parramatta Public Domain Guidelines](#).
- C.06 All pedestrian lanes, shared zones and service lanes must:
 - a) Be fully open to the sky.

- b) Be accessible to the public at all times.
 - c) Provide direct throughways with direct sightlines.
 - d) Be unencumbered by any basement car parking or any other private infrastructure under.
- C.07 Where a proposed lane or shared zone is not able to be dedicated to Council:
- a) The lane must be designed as part of the public street network, of equivalent status to the public domain, with its fully public nature embedded in the title arrangements.
 - b) The lane must be designed with the same parameters and finishes as required for Council owned lanes outlined in this section.
 - c) The lane must be named and signposted in the same way as for Council owned lanes.
- C.08 Pedestrian lanes must be clear of all obstructions, including columns, stairs, escalators and fixed furniture. A minimum of 50 per cent of lane width is to provide clear pedestrian access.
- C.09 Main building entry points on lanes must be clearly visible and defined as appropriately with canopies, building signage, lighting and high-quality articulation. Steps, handrails, or Tactile Ground Surface Indicators must not protrude into or interfere with the lane.
- C.10 Arcades are a secondary pedestrian option and must not to replace the role or function of a lane, shared zone, or service lane.

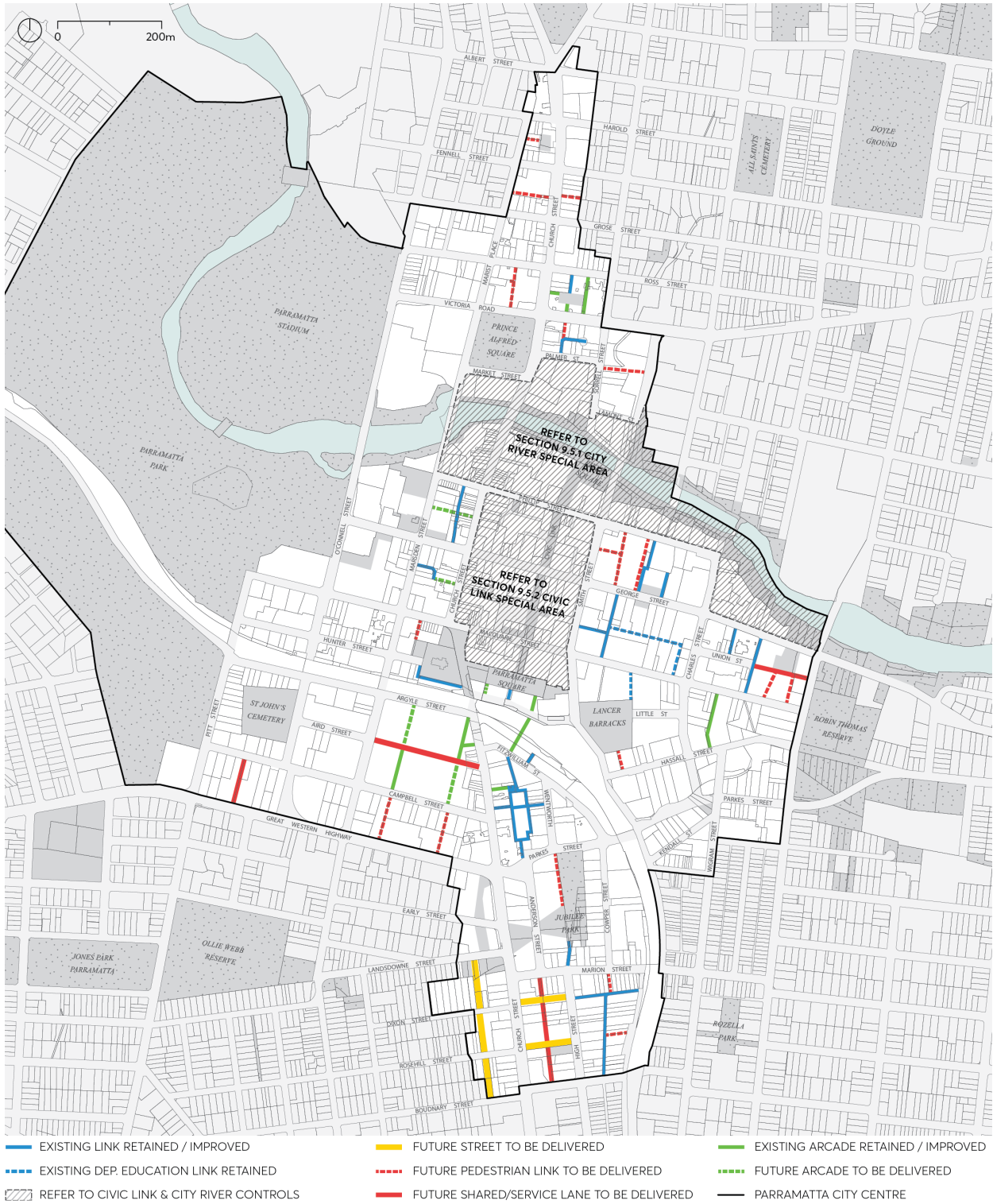

Figure 9.4.4.1 – Existing and Required Lanes

9.4.5 PEDESTRIAN OVERPASSES AND UNDERPASSES

Pedestrian access at street level is considered a priority in the City Centre to encourage an active and lively public domain. Pedestrian overpasses and underpasses are discouraged as they may create access issues for the mobility impaired, degrade streetscape quality and obstruct views and vistas along streets.

New pedestrian underpasses or overpasses will only be considered where they would directly connect to major transport nodes such as bus interchanges, or railway or metro stations and would substantially improve pedestrian safety and access due to compromised conditions at footpath level.

Objectives

- O.01 Minimise intrusions into the streetscape or wider public domain and maintain views and vistas along streets.
- O.02 Provide substantially improved pedestrian safety and accessibility where these are significantly compromised to major transport nodes.

Controls

- C.01 Any proposed overpass or underpass must demonstrate how it substantially improves pedestrian safety and accessibility.
- C.02 Any proposed overpass or underpass must:
 - a) Provide access wholly within the development site, be accessed directly from a suitable public space and be flush with the street alignment boundary.
 - b) Provide direct connection under or above adjacent streets.
 - c) Not reduce dimensions or circulation space of existing public domain and footways.
- C.03 The design of any overpass or underpass must satisfy 'safer by design' and crime prevention principles.

9.4.6 VEHICLE FOOTPATH CROSSINGS

The design and location of vehicle access to developments should minimise conflicts between pedestrians and vehicles on footpaths, particularly along primarily pedestrian streets. Vehicle access should also be designed to minimise visual intrusion and disruption of the public domain.

Porte-cocheres are not encouraged as they disrupt pedestrian movement, do not contribute to active street frontage, and provide no public benefit.

Objectives

- O.01 Provide a simple, legible, and direct pedestrian footway on all streets.
- O.02 Make vehicle access to buildings more compatible with pedestrian movements and the public domain.
- O.03 Prioritise safe pedestrian movements within the public domain.
- O.04 Ensure vehicle entry points are integrated into the building design and contribute to high quality architecture and streetscapes.
- O.05 Minimise the width of any vehicular footpath crossing.
- O.06 Ensure vehicle access to heritage items is not detrimental to the values, setting or context of that heritage place.

Controls

- C.01 No additional vehicle entry points will be permitted into the parking or service areas of development along those streets identified as significant pedestrian circulation routes in Figure 9.4.6.1.
- C.02 In all other areas, one vehicle access point only will generally be permitted, which is to include the access for service vehicles and parking for both residential and non-residential uses within mixed use developments.
- C.03 Where practicable, vehicle access must be from lanes and minor streets rather than primary street fronts or streets with major pedestrian activity.
- C.04 Vehicle slip lanes in public streets for private use are not permitted.
- C.05 Where practicable, adjoining buildings must share or amalgamate vehicular access points, basements and servicing facilities. Internal on-site signal equipment must be used to allow shared access. Wherever appropriate, new buildings must provide vehicle access points that can be shared at a later date.
- C.06 Vehicle access ramps must be perpendicular to the street frontage to minimise the width of vehicle entry and exit openings.
- C.07 Vehicle landings (for the length of one vehicle) must be flush with the public domain to maximise visual contact with oncoming pedestrians.
- C.08 The design of vehicle access doors to vehicle access points must be fitted behind the building facade and be of materials that integrate with the design of the building and that contribute positively to the public domain.
- C.09 Vehicle entries visible from the street when doors are open must have a high quality finish to walls and ceilings as well as a high standard of detailing. No service ducts or pipes are to be visible from the street.
- C.10 Porte-cocheres may be permitted in exceptional circumstances for hotels and major tourist venues, subject to high quality urban design, streetscape, heritage and pedestrian safety and amenity considerations.

- C.11 If permitted, a porte-cochere must be internal to the building with one combined vehicle entry and exit point, or one entry and one exit point on two different street fronts of the development. In exceptional circumstances, for buildings with one street frontage only, an indented porte-cochere with separate entry and exit points across the footpath may be permitted.
- C.12 A porte-cochere must be constructed level to the public domain.

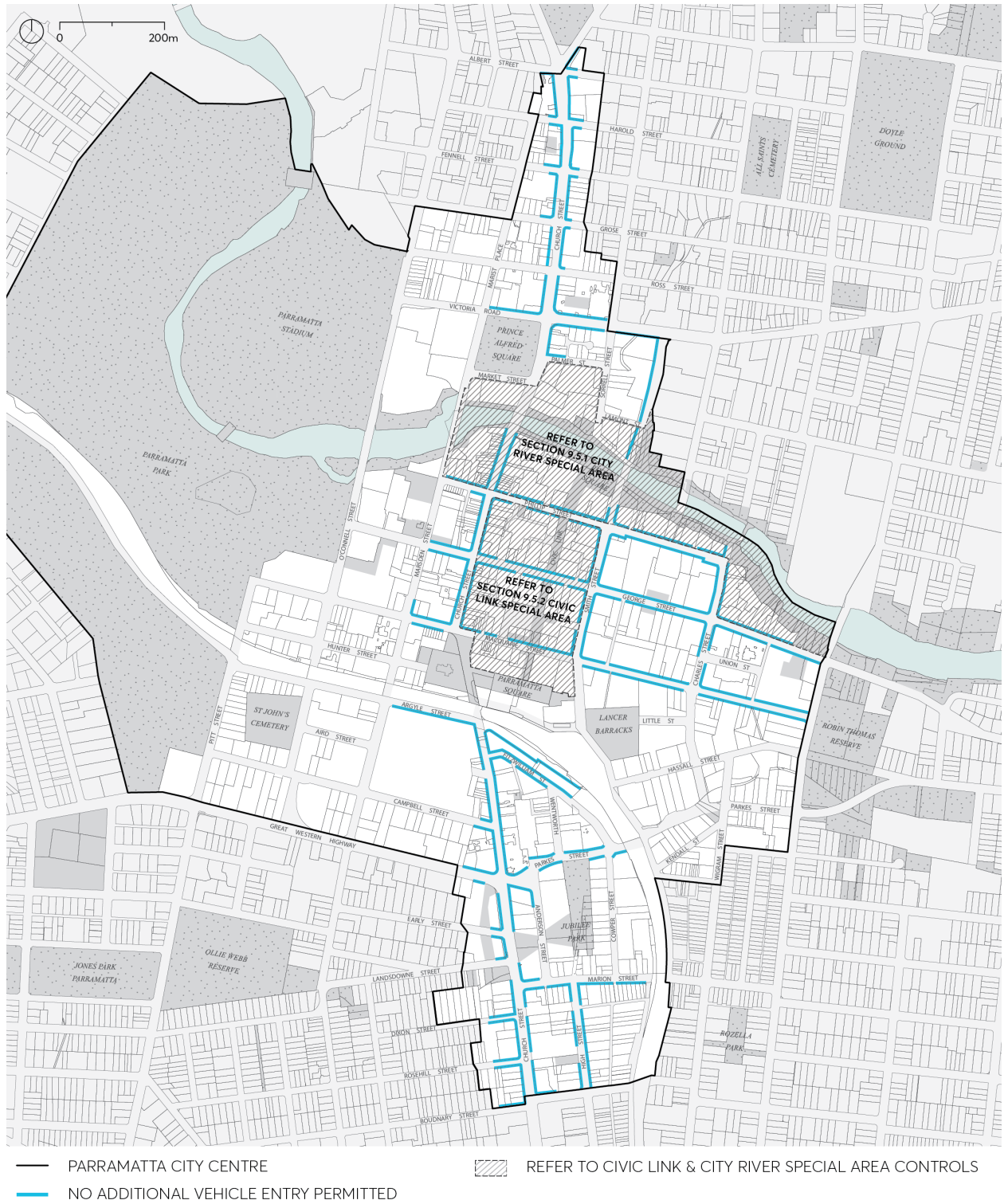

Figure 9.4.6.1 – No Additional Vehicle Entry Permitted

9.4.7 VIEWS

Important views contribute to way finding and a sense of place and identity for the city. Views are shaped and informed by their surrounds.

The physical setting of the Parramatta City Centre, generally framed by Parramatta Park, Parramatta River, and the heavy rail corridor makes for special views of the natural setting with significant heritage and cultural elements. It is important that significant views within, into and out of the city are maintained from as many points in the public domain as possible.

Design that acknowledges the value of important views can protect and enhance these views, thereby contributing to the character and quality of the public domain.

The controls in this section apply to sites within the City Centre that are affected by view corridors illustrated in Figure 9.4.7.1.

Objectives

- O.01 Reinforce the sense of place and way finding in the City Centre.
- O.02 Maintain and enhance views from the City Centre to significant heritage, natural features and significant trees.
- O.03 Maintain and reinforce views along streets and to urban spaces.
- O.04 Maintain views of silhouettes of the tops of major buildings or structures as seen against the sky.
- O.05 Encourage views from Parramatta City Centre to Parramatta River and to Parramatta Park.

Controls

- C.01 Where a proposed development is within the corridor of the identified views in Figure 9.4.7.1 and Table 9.4.7.1, an analysis must demonstrate:
 - a) The impact of the proposed development.
 - b) How the view is maintained and reinforced by the proposal.
 - c) How the view informed site planning, architectural form, finish, materials and detailing of the proposal.

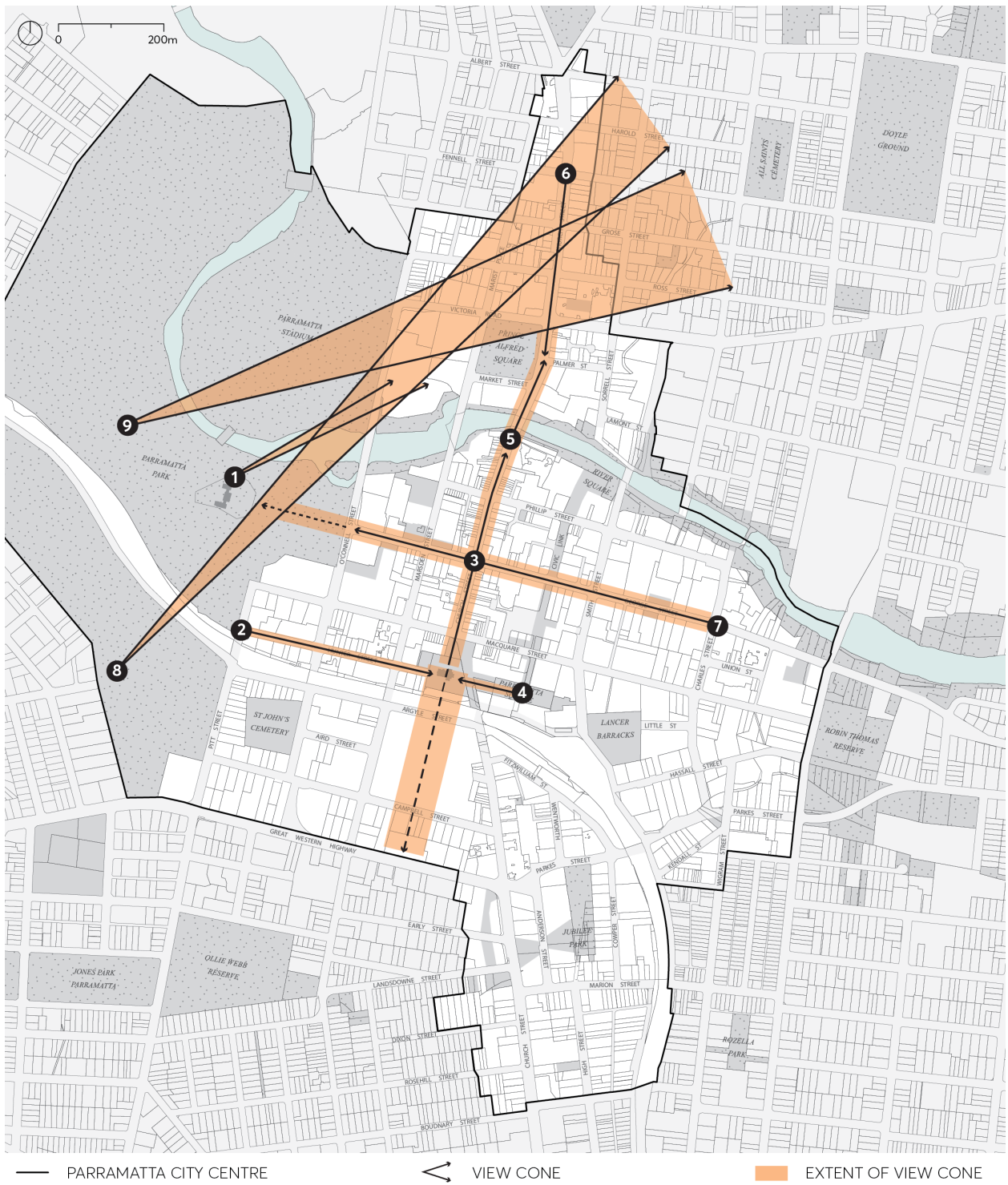

Figure 9.4.7.1 – Historic Views to be protected

Table 9.4.7.1 – Identified Historic Views to be protected

	Identified View	Significance
1.	Old Government House view northeast to the river, Old King's School building and site of former Government farm.	Key historic view demonstrating the relationship between the Governor, early Government farm and major school institution. Setting of both heritage items.
2.	Views east along Hunter Street to St John's Cathedral and spires, available back to Parramatta Regional Park.	Vistas along Hunter Street providing a framed view to St John's Cathedral, across the cathedral grounds towards the Town Hall, and to the site of the Governor's annual 'feast' with Aboriginal clans (instituted by Governor Macquarie) that took place at the rear (eastern end) of the Cathedral.
3.	Views southwards to and beyond St John's Cathedral and Centenary Square, and northwards along the procession of Church Street.	Historic main street approach to City Centre and St John's Cathedral with other heritage items in view, as well as the procession and views from St John's northwards, up Church Street. Views from Church Street towards St John's Cathedral must allow the silhouette of the Cathedral spires to be seen against the sky.
4.	Views west along Parramatta Square to St John's Cathedral, past the Town Hall.	Backdrop and setting of church. Views to the Cathedral and spires.
5.	Views north and south along Church Street, including views of the Western Sydney Stadium and heritage buildings, St John's Church spires to the south and St Peter's church.	Historic main street and approach to city, framed by a number of heritage buildings and recurrent views to Parramatta Park.
6.	Approach to Parramatta along Church Street from Fennell Street, and sequential views southward.	Historic main street and approach. Relatively consistent scale and setback of streetscape.
7.	Views along George Street to Parramatta Park / George Street Gatehouse and trees.	Key historic street approach to the park and Old Government House. City edge of park, framing views to George Street Gatehouse, trees, and Old Government House (not now visible), views of streetscape, heritage items.
8.	View from Marys Hill across Parramatta's City Centre to distant hills.	Key historic viewing point from the highest part of the Parramatta Park with best views of the city in the river valley, glimpses to hills behind the city between buildings.
9.	View from The Crescent to the distant hills Key historic viewing point from the ridge of The Crescent.	Key historic viewing point from the ridge of The Crescent to glimpses of distant hills between buildings.

9.5 SPECIAL AREAS

Special Areas are defined precincts with distinctive conditions that require specific controls relating to the characteristics of the area. Development within a Special Area must respond to the particular attributes and qualities of that place.

This Special Areas section should be read in conjunction with the other sections of the City Centre controls. Unless modified or specifically excluded in this section, all controls in Sections 9.1 - 9.4 and Sections 9.6 - 9.9 apply to development in Special Areas.

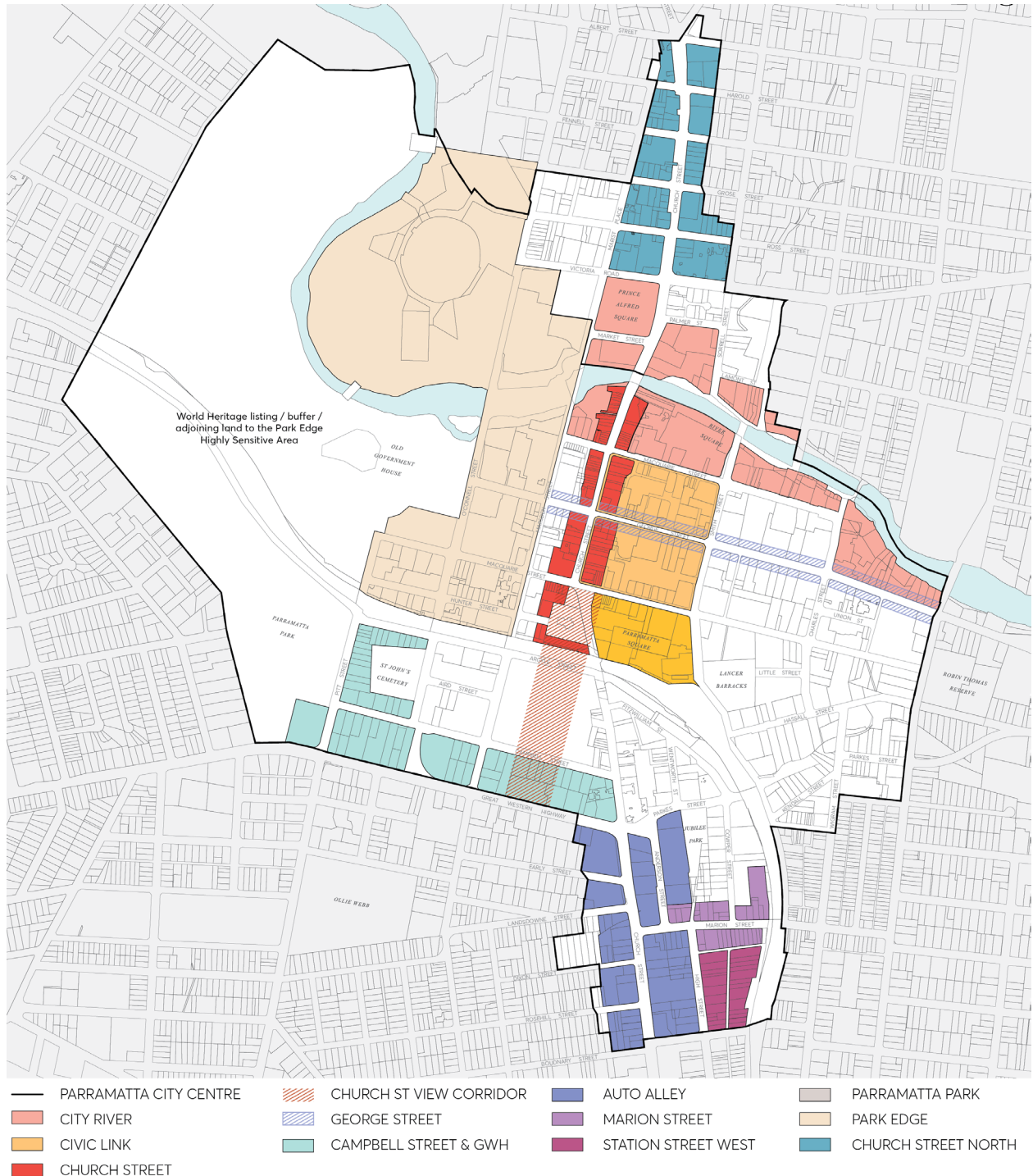

Figure 9.5.1 – Parramatta City Centre Special Areas

9.5.1 CITY RIVER

The history of the Parramatta City Centre is interwoven with the River. The banks of the River have been inhabited by Aboriginal people for tens of thousands of years, providing fresh water, food and transport for the Dharug people and other Aboriginal clans that lived, met and sustained ongoing cultural practices along its course. The City River Special Area occurs at the place where the salt water of Sydney Harbour meets the freshwater extent of Lake Parramatta and continues to remain a culturally important place for Aboriginal people today. Traces of this rich history and ongoing culture are evident in the Pleistocene sand sheet and Aboriginal Archaeology which occur along the banks of the river, underpinning and in many instances occurring side by side with the City's European history and heritage.

Within the bounds of the City Centre, the river itself is approximately 30 metres wide and is traversed by several vehicular and pedestrian bridges. This includes the heritage listed Lennox Bridge, first completed in 1839, which carries Church Street across the River as the main north-south street in the City Centre.

Existing development on both sides of the river consists of low, medium, and large-scale buildings that vary in age, uses and ownership. A number of these buildings are of heritage significance which contribute to the character and the cultural importance of the precinct. The river frontage is edged with a mixture of buildings and green space. Pedestrian walkways are located along both sides of the river edge, however there are no public streets between the buildings and the water.

On the north bank, street blocks generally run perpendicular to the river responding to the hilly topography and providing views to the river and southern shore. On the south bank, consistent with the historical access from the river along George Street, the street blocks run parallel to the river on the flat topography of the floodplain. Views to the northern shore from the public domain on this side are more limited. The City River Special Area controls aim to acknowledge the different design responses that are required for the north and south banks.

A key unifying element within the City River Special Area is the River Square, which establishes a direct connection to Parramatta Square through Civic Link. The Riverside Theatre is located on the north bank between Marsden and Church Streets, and on the south bank the new Powerhouse Parramatta is to be located at the end of Civic Link. The City River Special Area also incorporates other important places such as the Charles Street Square adjacent to the Parramatta Wharf, and Prince Alfred Square – one of the oldest formalised civic spaces in New South Wales.

The following controls are designed to refocus activities along the river and to ensure that future development addresses and defines the river space. Existing view corridors will be reinforced by the buildings and new view corridors and connections introduced. Pedestrian paths above the flood plain level will offer opportunities to engage with the river.

The City River Special Area has been divided into a series of distinctive blocks that are bound by the Parramatta River's bridges as per Figure 9.5.1.1; the Cultural Block, the City West Block, the City East Block, and Parramatta Quay.

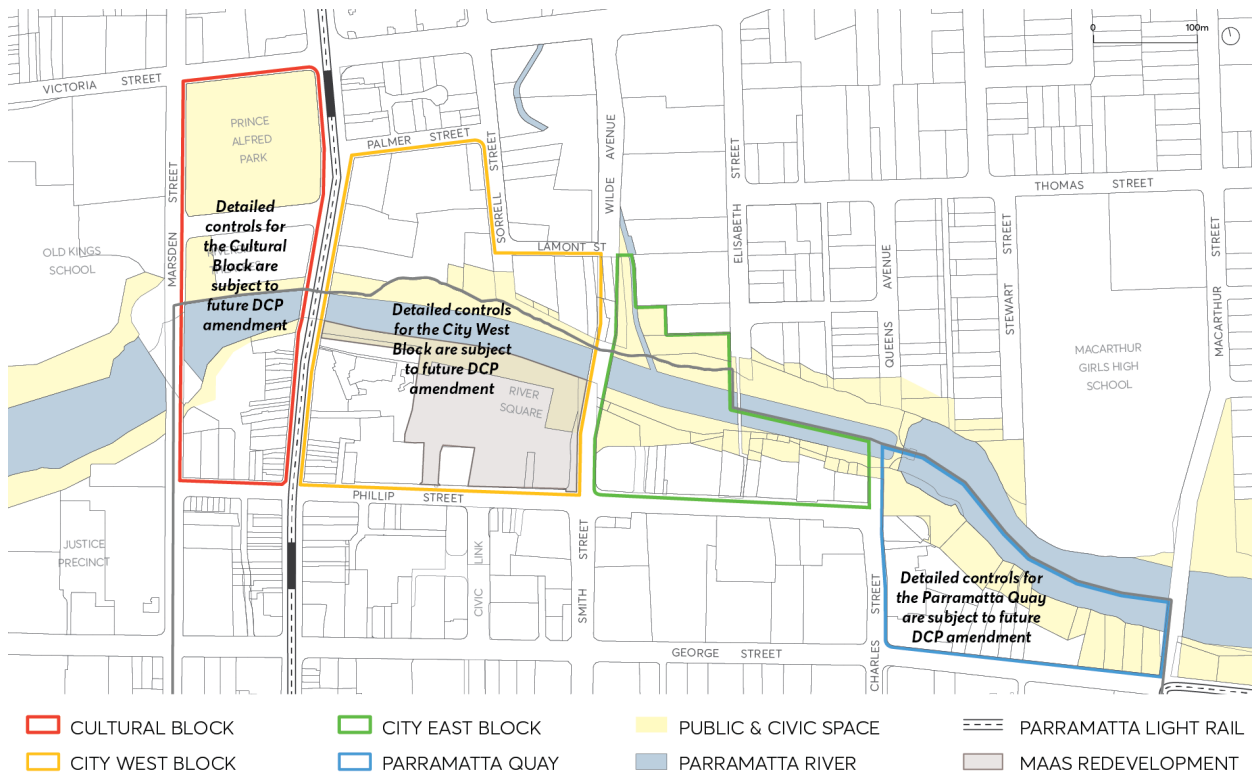

Figure 9.5.1.1 – City River Special Area

Objectives

- O.01 Respectfully acknowledge, celebrate and express the ongoing cultural importance of the Parramatta River to Dharug and Aboriginal people.
- O.02 Celebrate the unique Parramatta River landscape setting, views, and topography of the City Centre.
- O.03 Ensure future development contributes to the activation of the river, strengthening the significance of the river to the City Centre.
- O.04 Strengthen the visual and physical north-south connections between the city and the river.
- O.05 Maximise pedestrian connections at lower and upper levels of the river foreshore to ensure contiguous east-west movement is achieved.
- O.06 Balance the needs of the natural and built environment, enhancing the Parramatta River as the major natural and cultural asset of the City Centre.
- O.07 Maximise sun access to the foreshore and adjacent public open spaces.
- O.08 Enhance the interface between private and public land along the river, ensuring future development addresses the river and contributes to the overall quality, safety and amenity along the river foreshore.
- O.09 Preserve the Parramatta River as a priority corridor for ecological protection, flood sensitive design and future landscape improvements.
- O.10 Ensure flood response is integrated into the design of future development and appropriate escape routes above the floodplain is provided to ensure safety for the community.

- O.11 Frame the Parramatta River and its foreshore by providing consistent and defined building edge to the foreshore, with generous upper-level setbacks.
- O.12 Achieve an appropriate consolidation pattern that allows the objectives of the City River Special Area to be integrated into development proposals.
- O.13 Recognise the historical and contemporary importance of the precinct to the City's identity through:
 - a) Preservation of appropriate curtilage, surrounding scale and view corridors to heritage items.
 - b) Contextually responsive design and adaptive reuse of heritage buildings.
 - c) A curated collection of high quality, contemporary heritage interpretation and public art which enlivens the public domain.

9.5.1.2 CITY EAST BLOCK

The following controls apply to the City East Block within the City River Special Area. This block is bound by Wilde Avenue, Phillip Street, Charles Street Square, and the north bank river foreshore open space. On both sides of the river, a continuous foreshore promenade allows pedestrian and cyclist access along the water's edge before the land slopes steeply up and away from the water. The north bank is more densely vegetated and characterised by 3- to 4- storey residential brick buildings that have been generously set back from the foreshore. The south bank commands a more urbanised character, and an existing mix of residential and non-residential uses address the river front.

Brickfield Creek also joins the Parramatta River in this location, and the historically significant Convict Drain dating back to the 1820s passes through the south bank. A series of single storey cottages remain along Phillip Street, breaking up the street wall scale and are to be retained as local heritage items.

The most significant opportunity in the City East Block is to enhance existing views, and establish new views, towards the River. A new upper level promenade is to be delivered by future development to allow a continuous and active edge to the River that would be fronted by cafés, restaurants, bars and other retail tenancies – all with views over the Parramatta River.

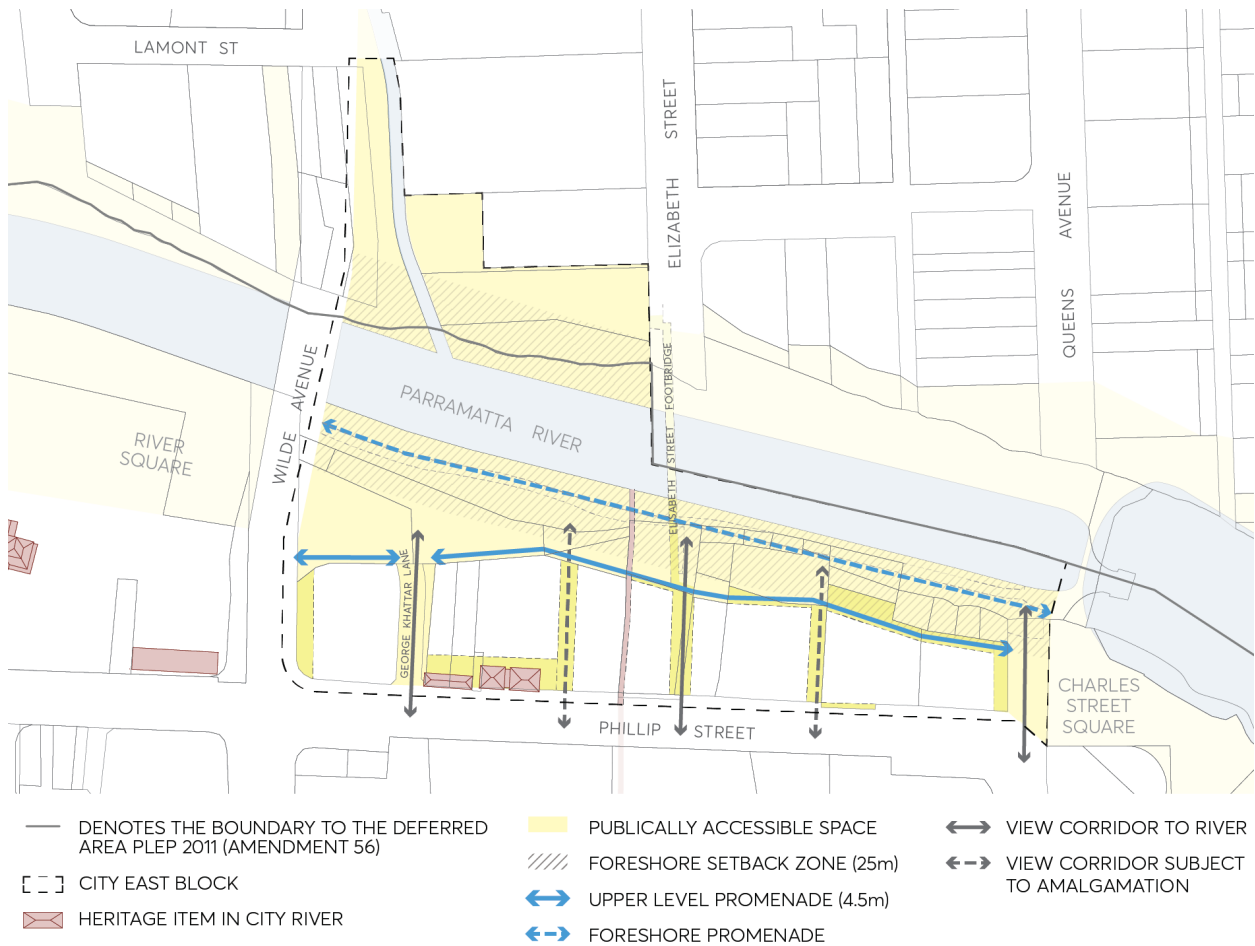

Figure 9.5.1.1.1 – City East Block Framework Plan

Objectives

- O.01 Define a continuous foreshore space between the river edge and future building face to provide a system of connected and accessible open spaces, as well as natural flood storage capacity.
- O.02 Frame views between buildings from Phillip Street to the river foreshore by maintaining and expanding view corridors along existing streets and laneways, and by creating new laneways.
- O.03 Create a premier river frontage and address for the City Centre that accommodates activities during the day and night.
- O.04 Delivers high quality architectural resolution when viewed along the river, from bridges and from across the river to the north.
- O.05 Provide a safe egress route during flood events that connects between Charles Street Square and George Khattar Lane and along George Khattar to Phillip Street or to refuge within buildings.
- O.06 Ensure any future development on the north bank that is located outside the City Centre and City River boundary acknowledges the significance of the river foreshore and responds to the objectives of the City River Special Area.

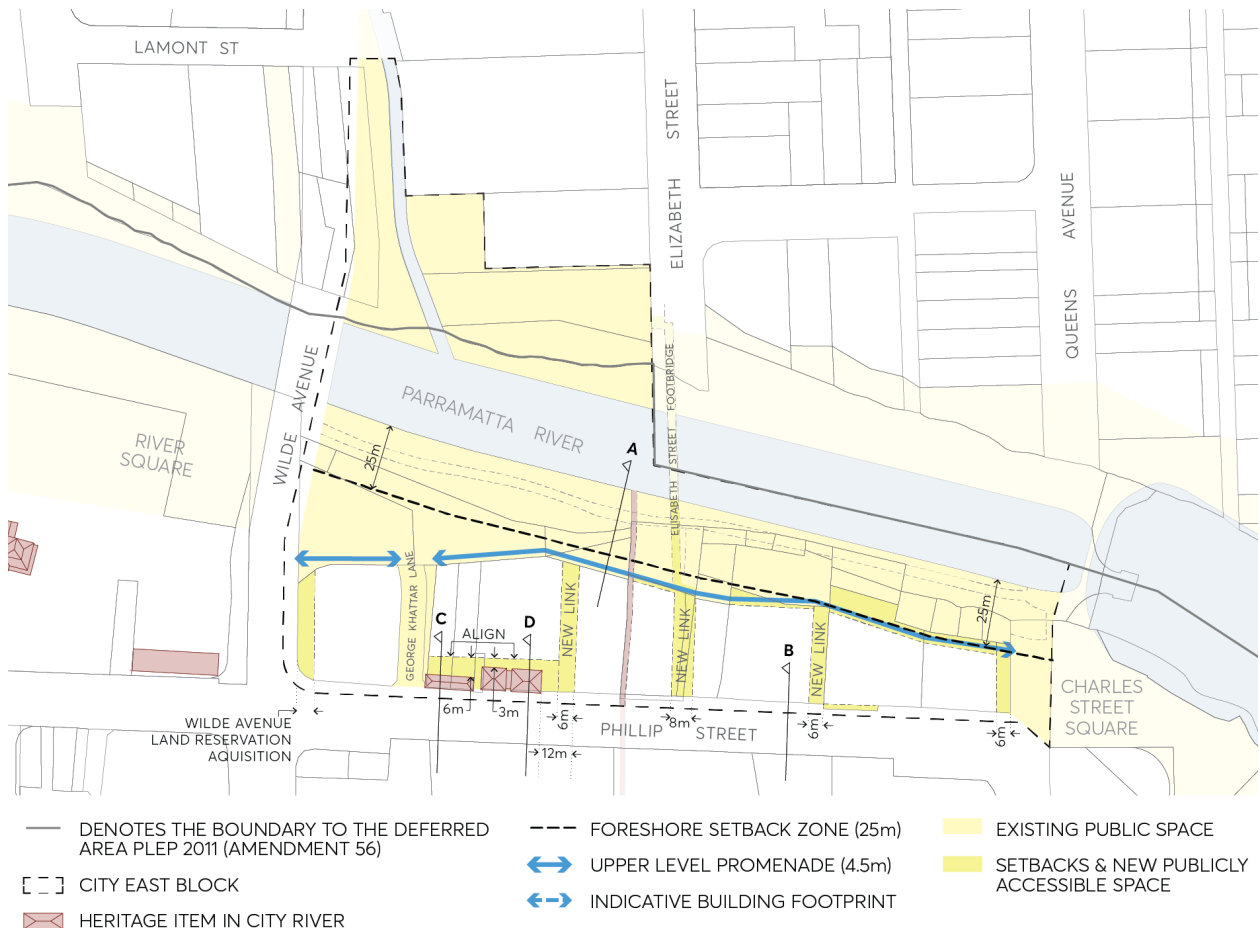

Figure 9.5.1.1.2 – City East Block Public Domain

Controls

Unless modified or specifically excluded below, all controls in Sections 9.1 to 9.4 and Sections 9.6 to 9.9 of this Part apply to development within the City River Special Area City East Block.

- C.01 Development must comply with Figure 9.5.1.1.2 and be setback a minimum of 25m from the river’s edge and/or align with the future alignment of the upper-level promenade.
- C.02 Site consolidation must allow for the realisation of the objectives of the City River Special Area and desired publicly accessible through site links to be delivered as per Figure 9.5.1.1.2.
- C.03 A new upper-level promenade along the river frontage of properties must comply with Figure 9.5.1.1.3. Development must provide a 4.5 metres wide open to sky pedestrian walkway above the flood planning level along the northern boundary that is shared with the river foreshore. The horizontal and vertical alignment of the promenade is to be determined in consultation with Council.
- C.04 Street wall heights and setbacks along the river foreshore must comply with Figure 9.5.1.1.3 (Section A). Development on the south bank must provide a street wall height of 4-storeys along the foreshore, and towers must be set back 6 metres from the street wall.
- C.05 Development must provide ground level building entries to lift lobbies and ground level retail or restaurant tenancies that are directly accessible from the upper-level promenade. Multiple

storeys of non-residential uses on the river frontage are encouraged to increase activity along the foreshore edge.

- C.06 An awning must be provided along the upper-level promenade for weather protection and outdoor dining must be located within the building footprint to provide space for unobstructed pedestrian travel as shown in Figure 9.5.1.1.3 (Section A).
- C.07 Street walls facing the river must comply with the street wall controls in Section 9.3 – Built Form controls.

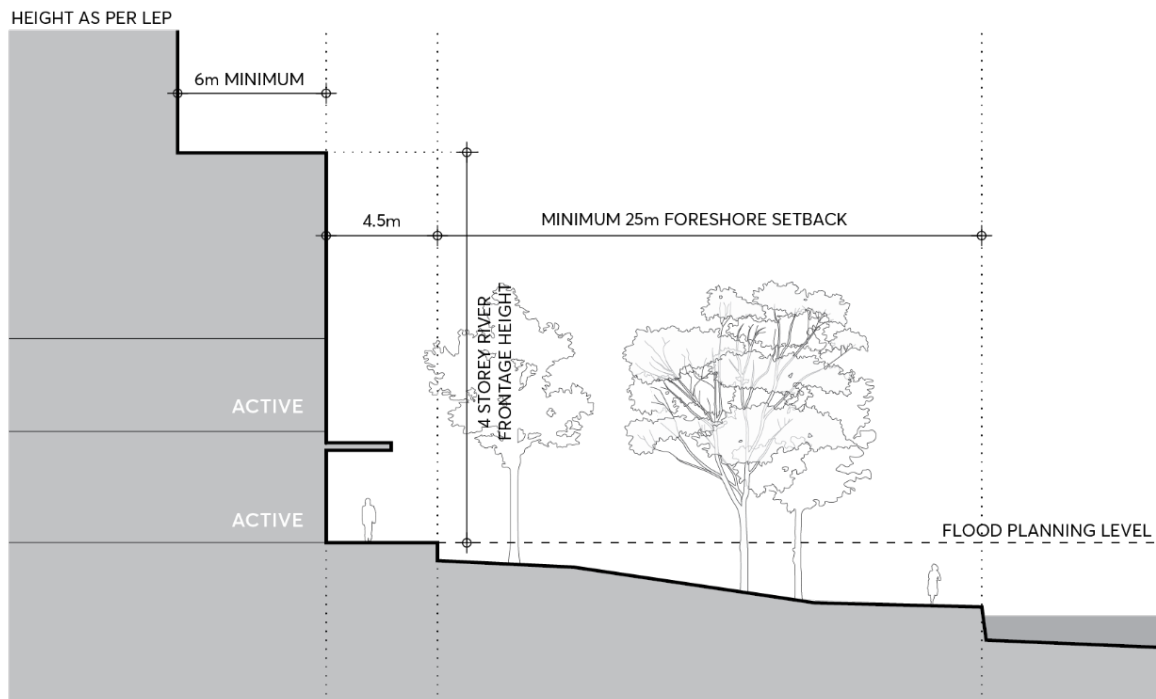

Figure 9.5.1.1.3 – City East Block Typical River Frontage (Section A)

- C.08 New through site links must be provided as per Figure 9.5.1.1.2. All new links must be open to sky, visually and physically connecting Phillip Street and the upper level promenade with extended views to the River corridor.
- C.09 The existing laneway at Elizabeth Street bridge must be widened to 8 metres with clear site lines between the bridge and Phillip Street, as shown in Figure 9.5.1.1.2.
- C.10 Development must prioritise locating car parking in basement structures to ensure active ground floor uses are provided along the river foreshore. Where basement car parking is considered inappropriate due to identified constraints such as archaeology or flooding, above ground car parking must be sleeved with active uses.
- C.11 At 90-96 Phillip Street, noting the lot configuration and land commitments for public purposes, development must provide a minimum 3 metre tower setback along the Phillip Street, Charles Street and River foreshore frontage that addresses wind, solar access and design objectives.
- C.12 At 60 Phillip Street, development must dedicate local road widening to Wilde Avenue as per the Land Reservation Acquisition Map in *Parramatta LEP 2023*.

C.13 Street setbacks and street wall heights on Phillip Street must comply with Figure 9.5.1.1.4 (Section B). Unless the site contains a heritage item, the street wall must be built to the boundary, and towers must be set back a minimum of 6 metres from the street wall.

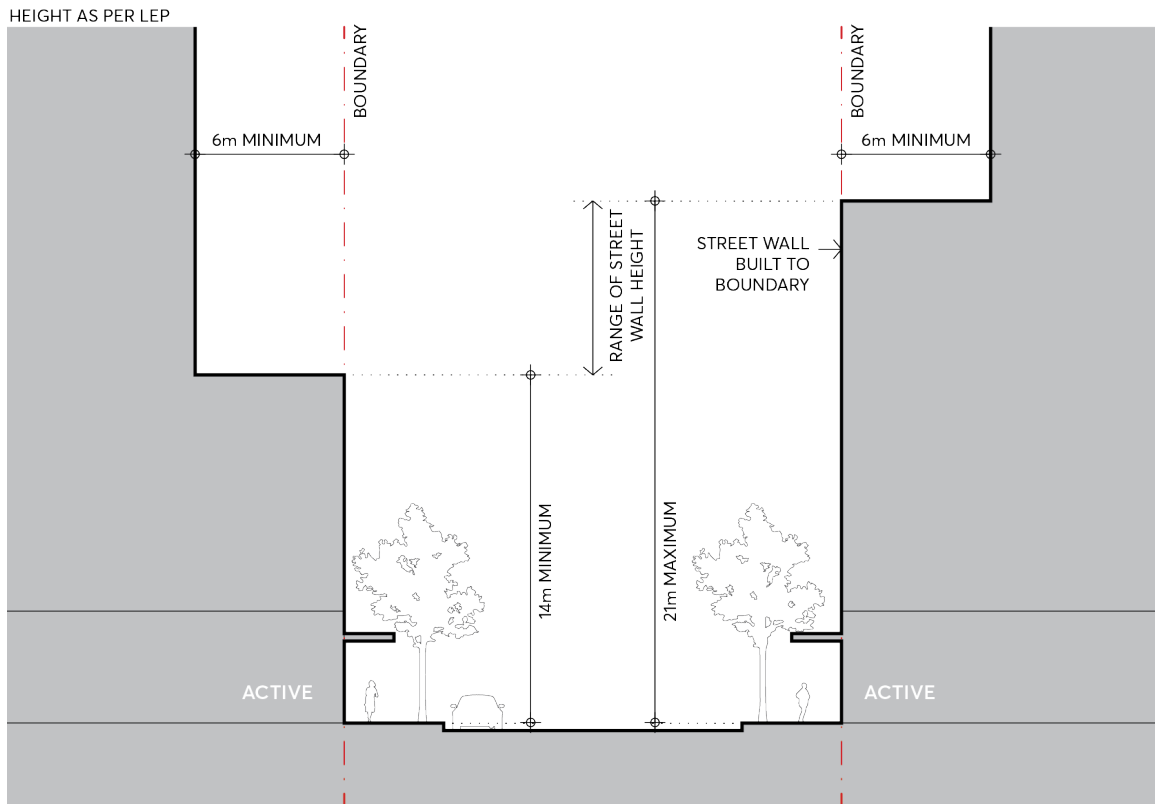

Figure 9.5.1.1.4 – City East Block Phillip Street (Section B)

C.14 Development must provide a 6 metre setback to heritage cottages on the lot known as 66 Phillip Street as per Figure 9.5.1.1.5 (Section C), and a 3 metre setback to heritage cottages on the lot known as 70-74 Phillip Street as per Figure 9.5.1.1.6 (Section D). An aligned building setback must be provided on the southern façade across the two properties as shown in Figure 9.5.1.1.2.

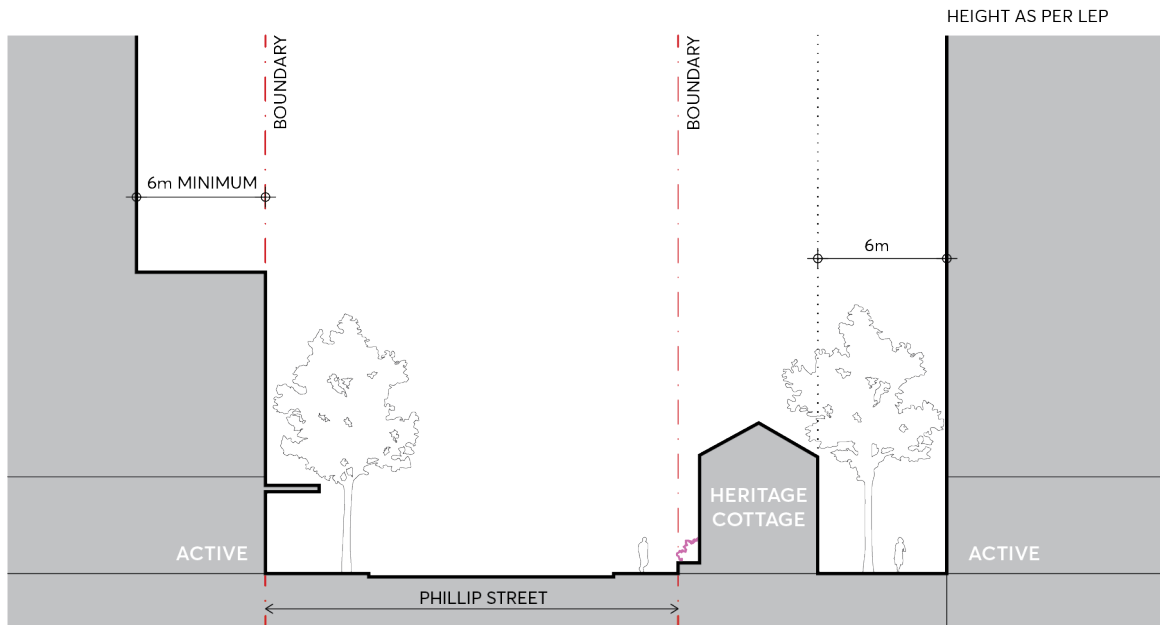

Figure 9.5.1.1.5 – City East Block Phillip Street at 66 Phillip Street (Section C)

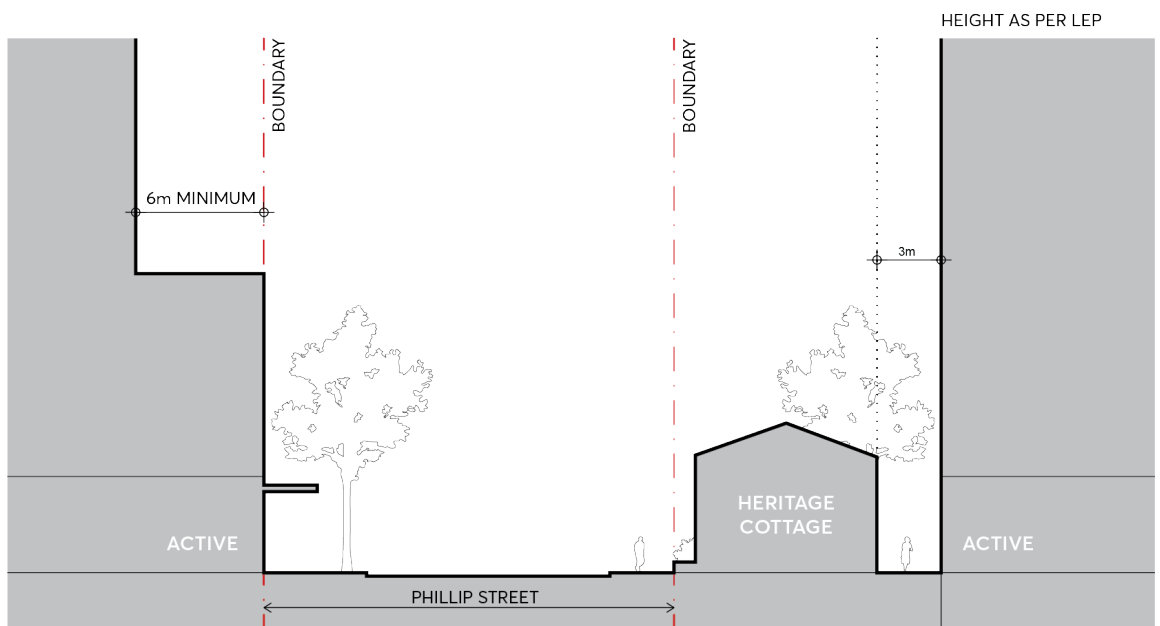

Figure 9.5.1.1.6 – City East Block Phillip Street at 70-74 Phillip Street (Section D)

- C.15 Heritage cottages must be adaptively re-used, allowing these items to contribute to an active streetscape character and maintain their significance.
- C.16 Clear egress for emergency, maintenance, and event vehicles to access the foreshore must be provided from George Khattar Lane.

9.5.2 CIVIC LINK

The Civic Link Special Area is located in the heart of the Parramatta City Centre. Central to the area is the Civic Link, a major new green, pedestrianised public space and cultural spine that connects Parramatta Square to the Parramatta River.

Civic Link spans 4 city blocks, divided by Macquarie, George and Phillip Street as shown in Figure 9.5.2.1.

In Block 1, the southern end of Civic Link is marked by the Leigh Memorial Church and the Town Hall. Civic Link connects directly to the Square and facilitates access to the existing bus and rail interchange and light rail stop.

In Block 2, Civic Link is a new north-south public space extending from Macquarie Street along the widened and pedestrianised eastern Horwood Place. The future underground metro station and associated development replaces the existing Horwood Place Car Park. Civic Link facilitates interchange between light rail, the metro station and the bus interchange on Smith Street. A new square provides a new setting for Kia Ora and the Leigh Memorial Church. The Roxy, a State listed heritage item, retains its use as a cultural landmark.

In Block 3, Civic Link follows the existing alignment of Horwood Place. Erby Place Car Park is retained in the short to medium term and continues to serve the CBD. Future site specific controls for the centre of the block, including the Erby Place Car park, aims to facilitate the long-term realisation of a new north-south street and east-west laneway, major commercial developments and the full pedestrianisation of Civic Link.

In Block 4, Civic Link extends through the Parramatta Powerhouse site and connects physically and visually to the River Square and the River Foreshore. Refer to Section 9.5.1 – City River for controls specific to this block.

The following Special Area controls for the precinct describe the alignment of Civic Link and supporting new streets and laneways to enable large city-shaping infrastructure, development projects and incremental change across multiple land holdings. New streets, laneways and squares increase pedestrian permeability and activity within the City Centre and enable access to transport and major cultural destinations. Vehicle and service access to existing and future properties is provided with the conversion of Civic Link to pedestrian use. Lot consolidation supports new commercial towers. A diversity of building forms and defined street wall heights reinforce the human scale edge to Civic Link and celebrates the retention and adaptive re-use of heritage buildings.

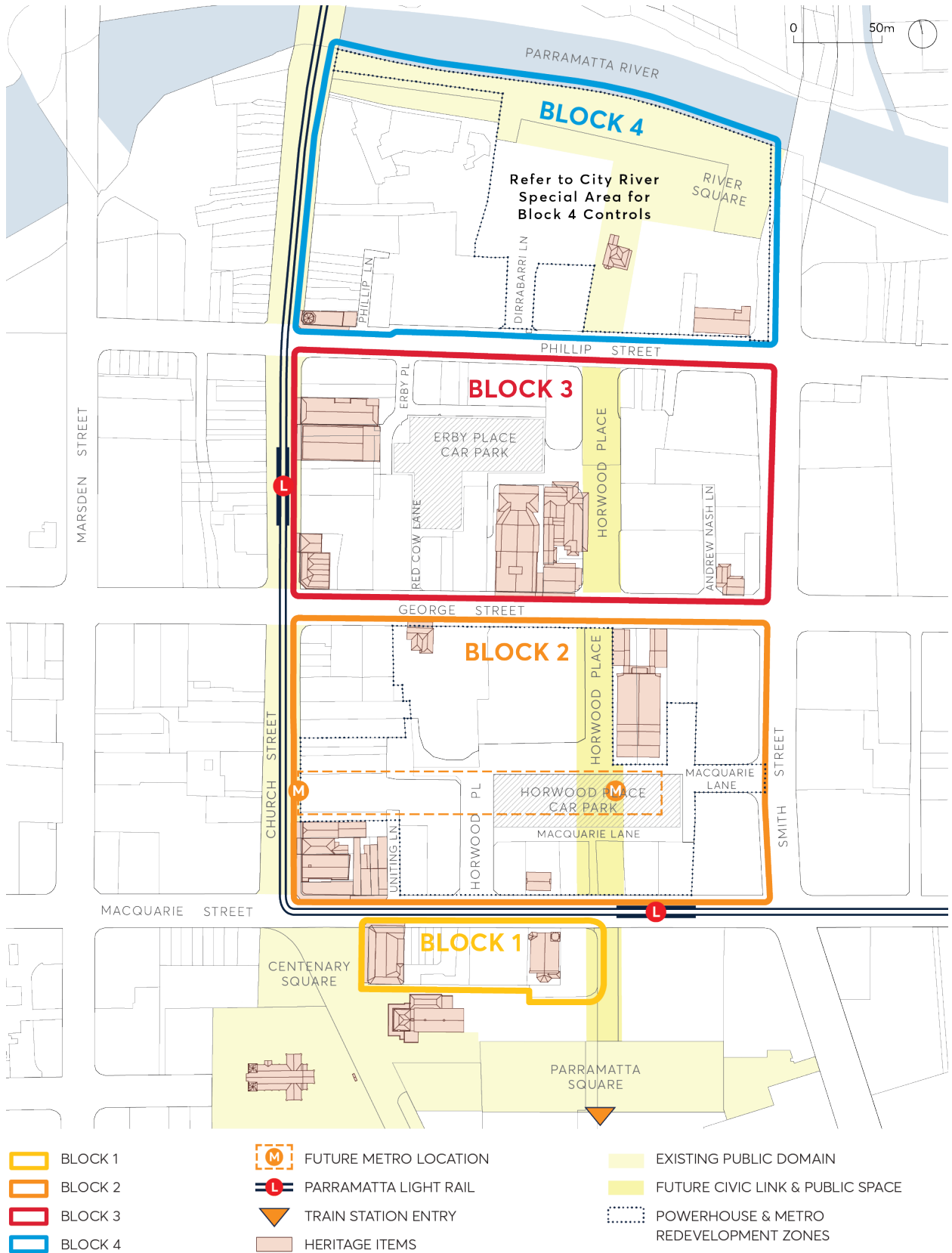

Figure 9.5.2.1 – Civic Link Special Area Blocks with Existing Context

Objectives

- O.01 Establish Civic Link as a new linear public space, open to sky and with an avenue of significant trees along its length, linking Parramatta Square to the Parramatta Powerhouse and River foreshore.
- O.02 Expand the street and laneway pattern within the block to prioritises pedestrian use and public and active transport choice, while also providing controlled vehicle and service access to existing properties and future developments.
- O.03 Dedicate Civic Link, streets, laneways and squares to Council.
- O.04 Ensure development supports a pleasant microclimate during all times of the year by protecting sunlight to Civic Link during lunch hours, and by mitigating urban heat island and reducing wind impacts from large development within the area.
- O.05 Frame view corridors along east-west streets and laneways toward Civic Link to reduce the perceived bulk of large commercial buildings.
- O.06 Promote equitable, viable development that supports the commercial core of the CBD and enables staged development across development parcels over time.
- O.07 Provide consolidated soil volume areas, stormwater management solutions, and underground utilities to facilitate a high-quality public domain. Structures under the public domain are not supported.
- O.08 Reinforce the pedestrian scale of the public domain with architectural design that provides human scale detail and with ground and lower-level building uses and frontages that support activity across the day, night and week. Space for temporary and permanent cultural uses, events and incubator spaces within the area, and in particular along Civic Link is desirable.
- O.09 Define building envelopes and street wall heights that assist in transitioning between large scale commercial buildings and retained heritage buildings.
- O.10 Spatially and visually differentiate free standing heritage buildings, including Kia Ora and the Roxy, from surrounding new development.
- O.11 Ensure the Roxy has a visual setting that allows it to be visually dominant in the immediate streetscape and not visually overwhelmed by new development.
- O.12 Create a new square around Kia Ora within a public space and with a connected tree canopy as a backdrop, when viewed from Macquarie Street.
- O.13 Create a new square to the east of Leigh Memorial Church that opens views to the church, expands pedestrian space and amenity adjacent the Parramatta Light Rail stop and define a generous threshold to Parramatta Square from Macquarie Street.
- O.14 Facilitate legible and easy transport interchange for pedestrians and cyclist within the public domain between the new Metro station at Civic Link, buses on Smith Street, light rail stops at Church and Macquarie Streets and the existing bus and rail interchange.
- O.15 Manage overland flow and stormwater to enable Civic Link's use as an escape route from the river to higher ground in the south during flood events.

Controls

Unless modified or specifically excluded below, all controls in Sections 9.1 – 9.4 and Sections 9.6 – 9.9 of the City Centre controls apply to development within the Civic Link Special Area.

- C.01 The alignment and width of Civic Link must comply with Figure 9.5.2.4 and must be open to sky without building encroachments or overhangs, with the exception of required awnings, along the full length of Blocks 1, 2 and 3.
 - a) In Block 1, Civic Link must have a minimum 20 metres width with 17 metres wide clear to sky building separation as indicated on Figure 9.5.2.3.
 - b) In Block 2, Civic Link must have a minimum width of 27 metres between Macquarie Street and Macquarie Lane, as indicated on Figure 9.5.2.3, with the exception of control C.0.6 (g) for a Metro Station.
 - c) In Block 2, Civic Link must have a minimum width of 20 metres between Macquarie Lane and George Street, measured from the western site boundary of the Roxy as indicated on Figure 9.5.2.2 (Section D).

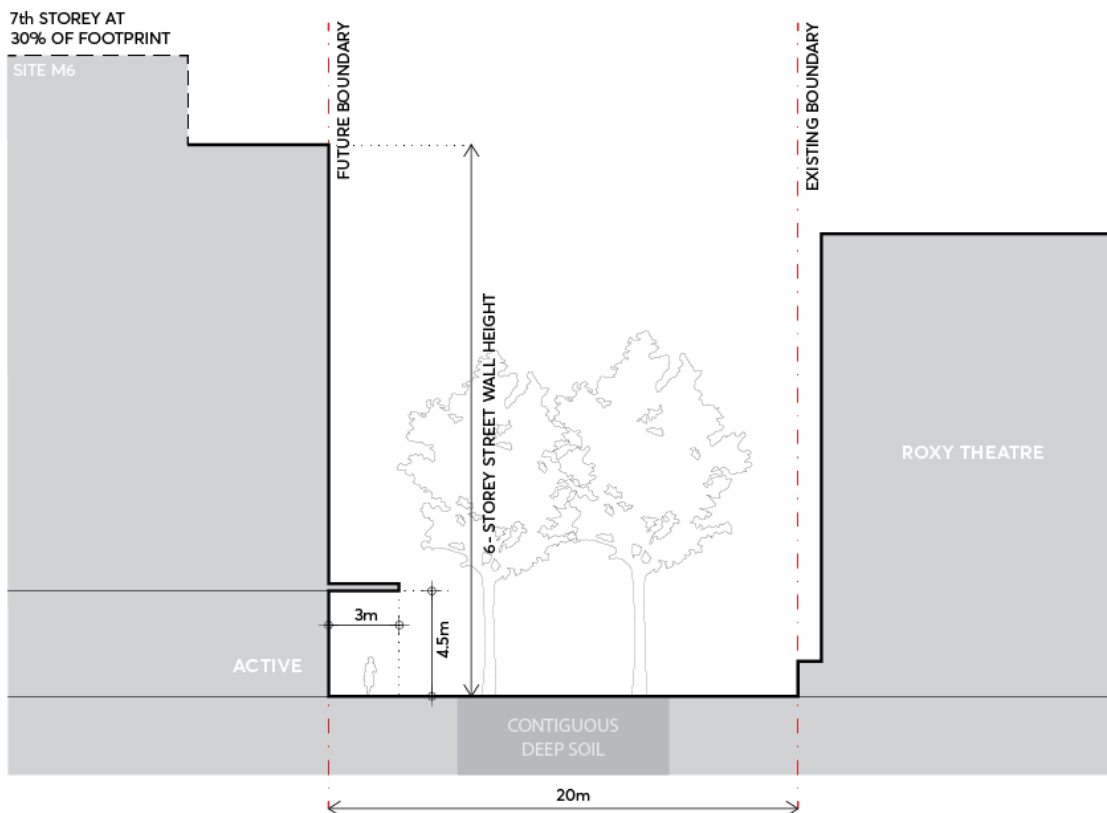

Figure 9.5.2.2 – Future Civic Link in Block 2 (Section D) Setback & Building Height

- d) In Block 3, Civic Link must follow the existing street reserve except on the eastern side where the predominant alignment at 1 and 3 Horwood Place (Sites 09 and 10) must be adopted as indicated on Figure 9.5.2.5.

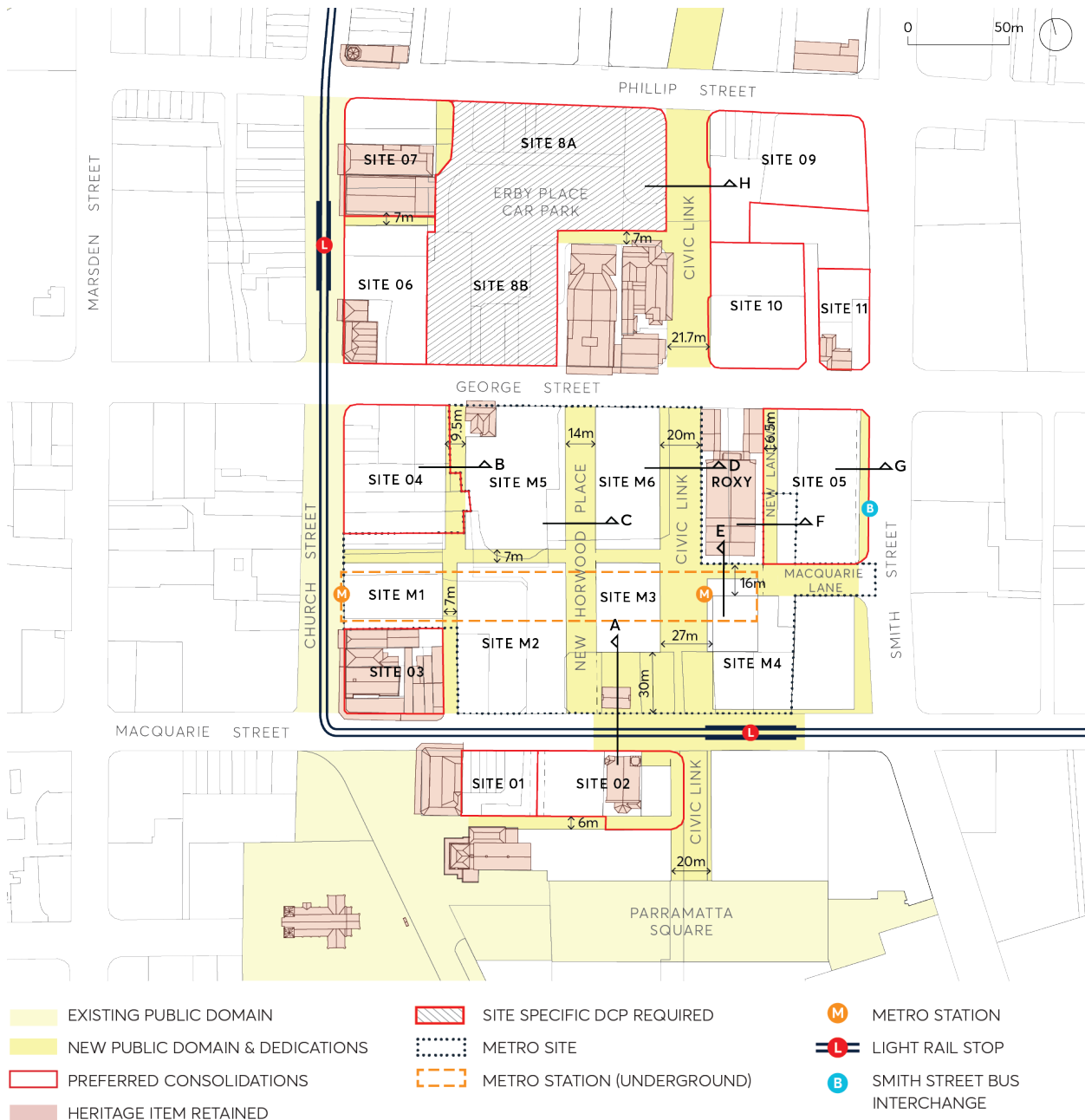

Figure 9.5.2.3 – Civic Link Special Area Public Domain & Consolidation

- C.02 Site consolidation must comply with Figure 9.5.2.3 to realise the objectives of the Civic Link Special Area. Where sites do not amalgamate as shown, buildings must comply with building separation, side and rear setback controls in Section 9.3 of the City Centre controls, including where an alternate amalgamation option for Site 05 is proposed that is exclusive of the Metro land.
- C.03 Streets, lanes and open spaces as indicated on Figure 9.5.2.4 must be delivered through development or dedicated to Council for delivery in a coordinated manner.
- C.04 New development and additions or alterations must not cause overshadowing of the pedestrian areas (Civic Link and squares and lanes) beyond the allowable building envelopes defined by the permissible FSR and building height in the LEP and the setbacks in this section.

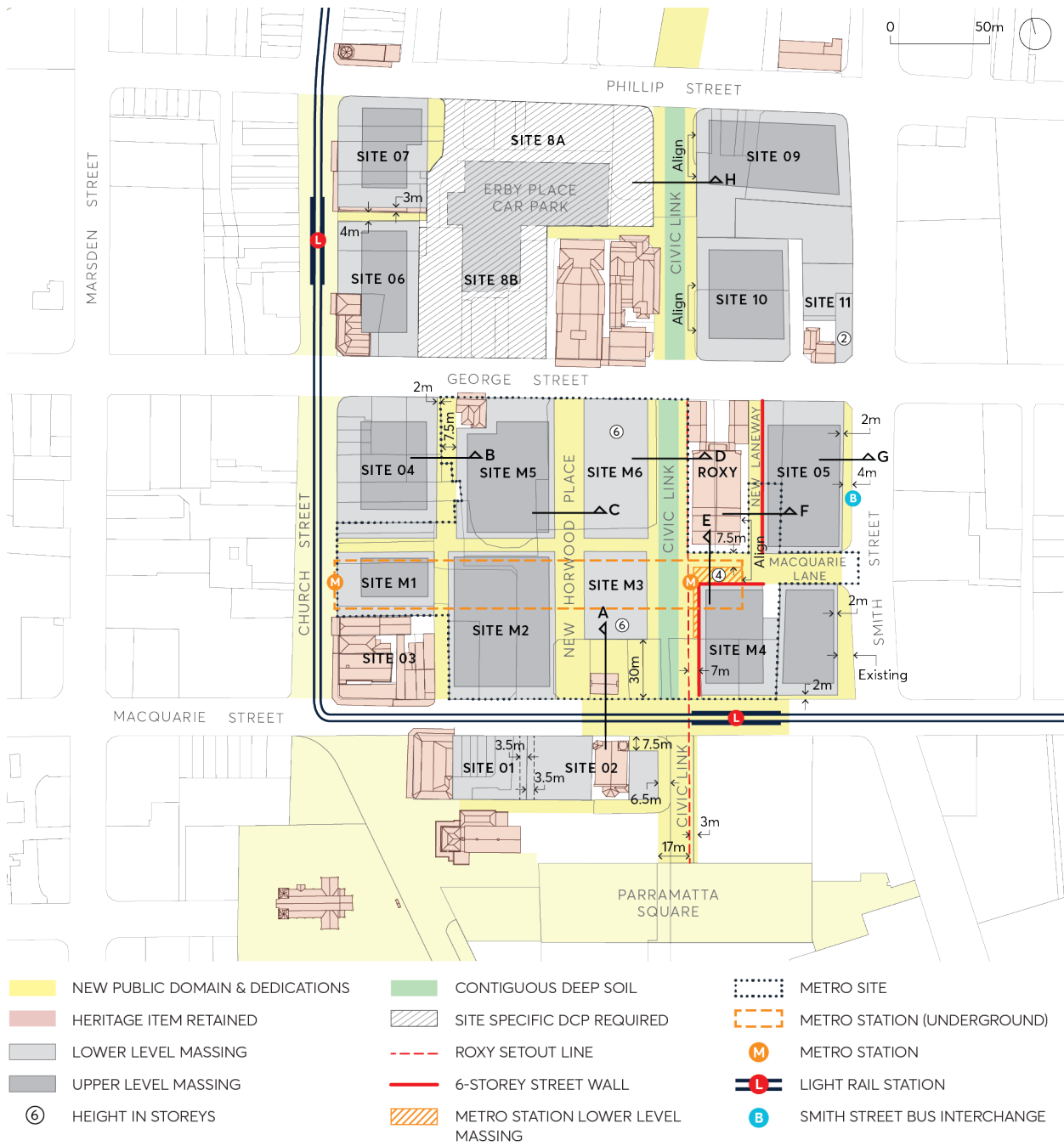

Figure 9.5.2.4 – Civic Link Streets and Public Spaces

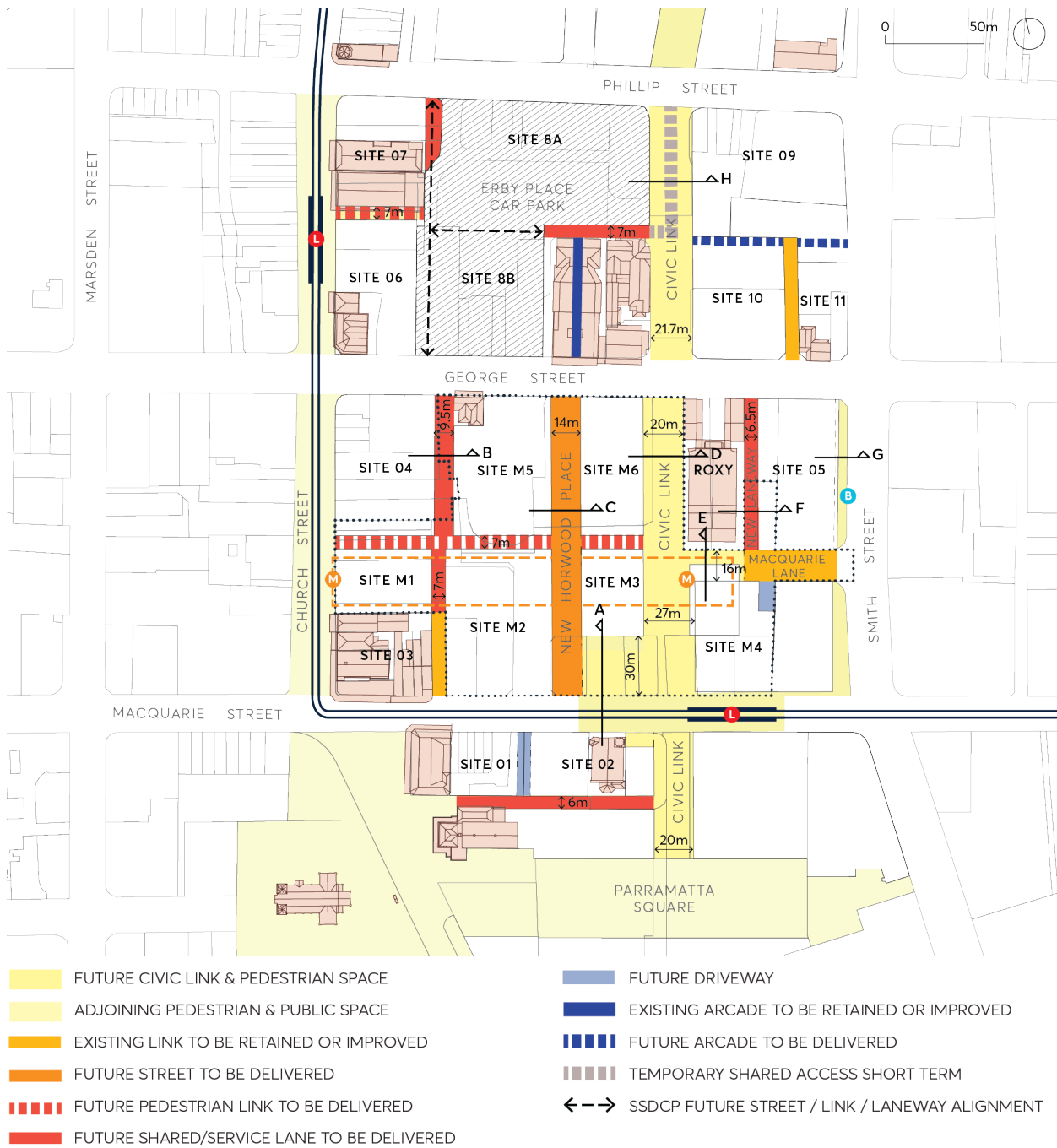

Figure 9.5.2.5 – Civic Link Setbacks and Indicative Built Form

C.05 Development within Block 1 must comply with the following specified envelope controls:

- a) Along Civic Link, a 4 storey/22 metre street wall height with an upper-level setback of 6 metres must be provided.
- b) Along the south side of Macquarie Street west of the Leigh Memorial Church, buildings must follow the street alignment and be built to the boundary. At 97 and 99 Macquarie Street, development must provide a 2 storey high, 3.5 metres wide service accessway on each property along the common boundary to create a combined 7 metres shared service access way across both properties.

- c) At 119 Macquarie Street, development must provide a minimum 7.5 metres setback to Macquarie Street in alignment with the southern edge of the Leigh Memorial Church; a minimum 6.5 metres setback along Civic Link to achieve a minimum 20 metres public domain corridor; and a minimum 6 metres setback from the southern boundary of 119 to achieve a laneway for vehicle and service access.
- C.06 Development within Block 2 must comply with the following specified envelope controls:
- a) Along the western edge of Civic Link and eastern edge of New Horwood Place in Block 2 (Sites M3 and M6), buildings must be a maximum of 6 storeys with an additional storey setback a minimum 6 metres with a maximum 30% footprint of the floor below to enable lift core, services and restaurant/ café uses. Landscape gardens on the remaining roof space is encouraged.
- b) Along George Street, a street wall of 6 storeys must be provided at Site 05 and Site M6 with a 12 metres upper level setback to storeys above the street wall.
- c) Street walls facing the Roxy at Site 05 western façade, Site M4 northern and western façade, Site M3 eastern façade and Site M6 eastern façade must be 6 storeys high (refer to Figure 9.5.2.6) and designed with a restrained architectural expression with the following:
- a regular form;
 - a regular pattern of openings;
 - a limited materials, finishes and colour palette, and without strong contrasts;
 - a horizontal top to the street wall without any stepping;
 - limited decorative details;
 - signage limited to the ground floor;
 - concealed services;
 - discreet night time illumination.

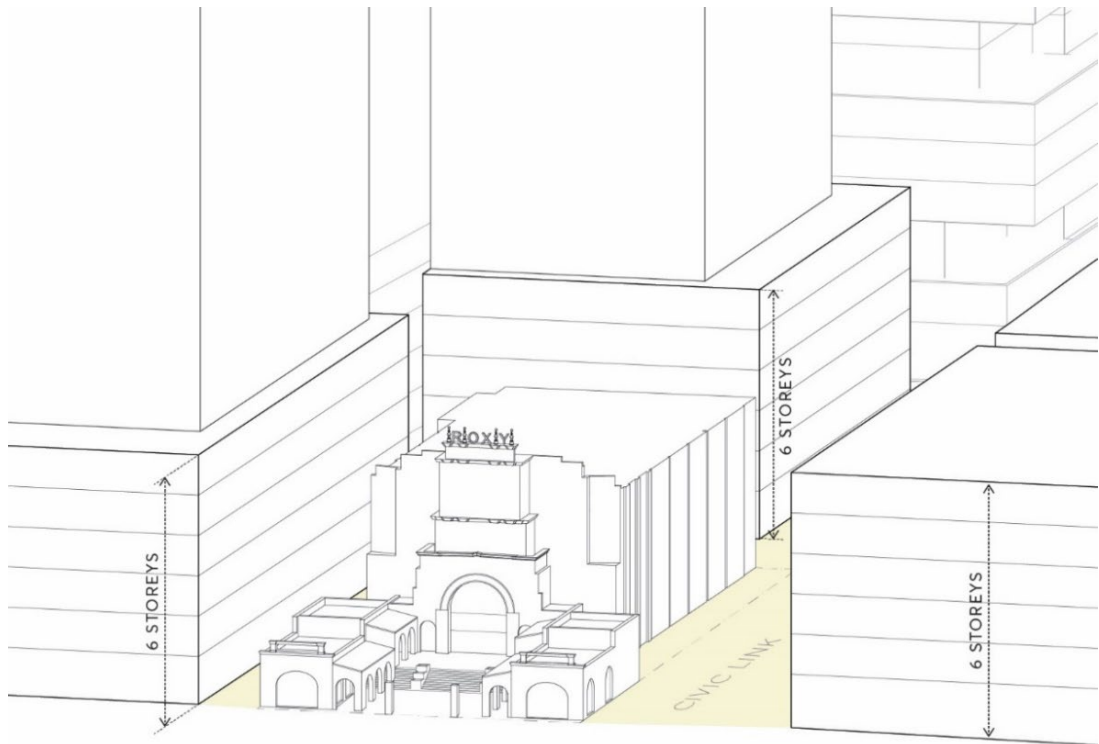

Figure 9.5.2.6 – Street Wall Heights next to the Roxy

- d) Setback new development 30 metres from Macquarie Street to the north of Kia Ora between Civic Link and New Horwood Place as per Figure 9.5.2.7 (Section A).

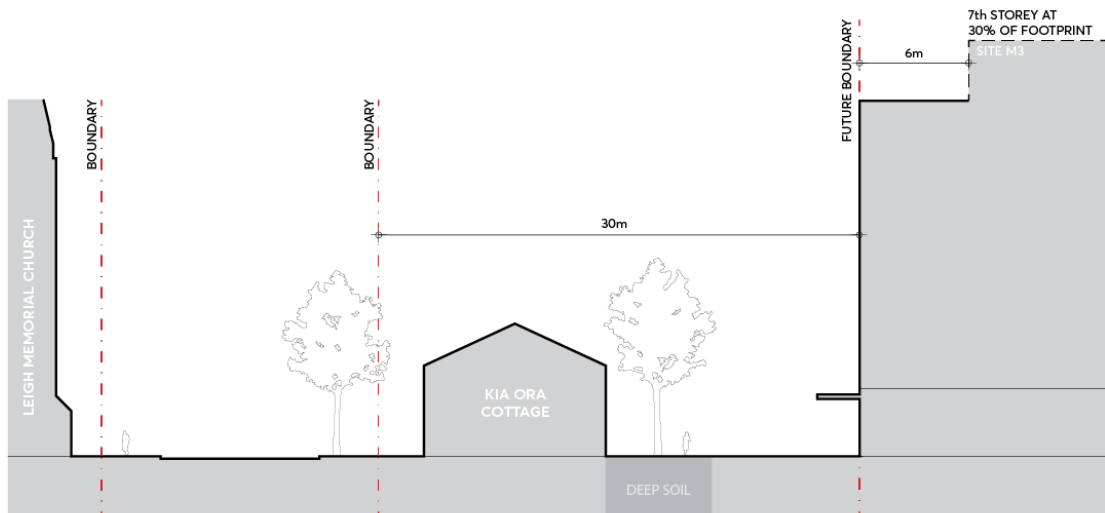

Figure 9.5.2.7 – Kia Ora Interface (Section A) Setback & Building Height

- e) Street setbacks and street wall heights on the New Horwood Place must comply with Figure 9.5.2.8 (Section C). Development on the western edge of Horwood Place must provide a street wall built to the future boundary, and minimum 3 metre upper-level setback. Development on the eastern edge of Horwood Place must provide a 6-storey street wall height built to the future boundary, and 6 metre upper-level setback.

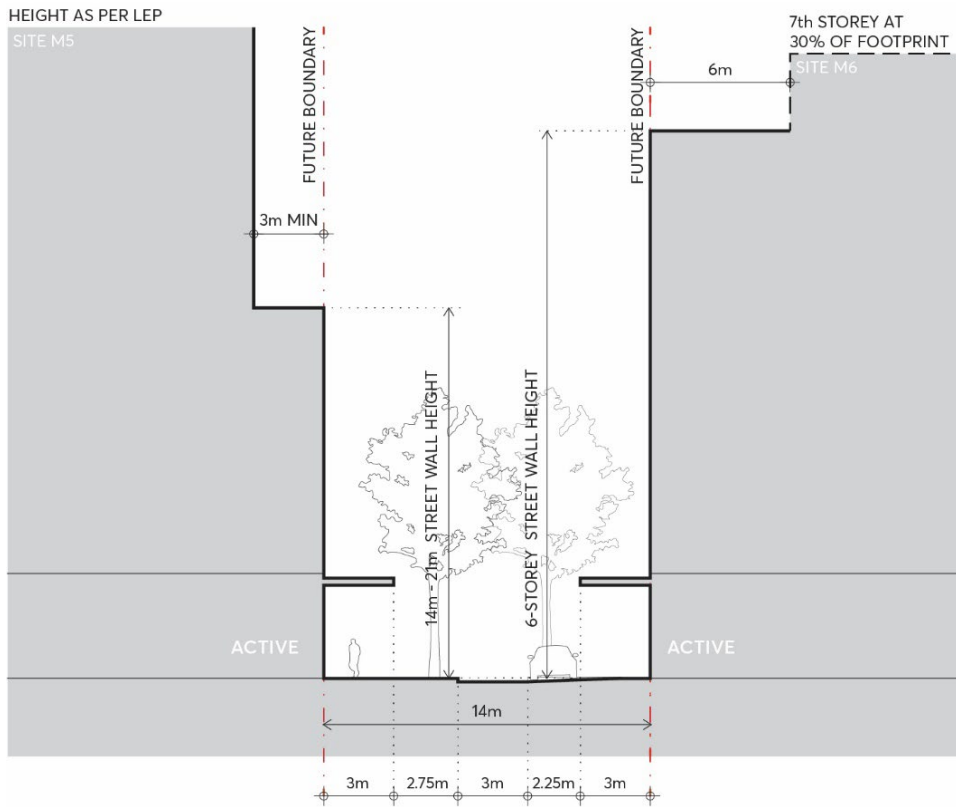
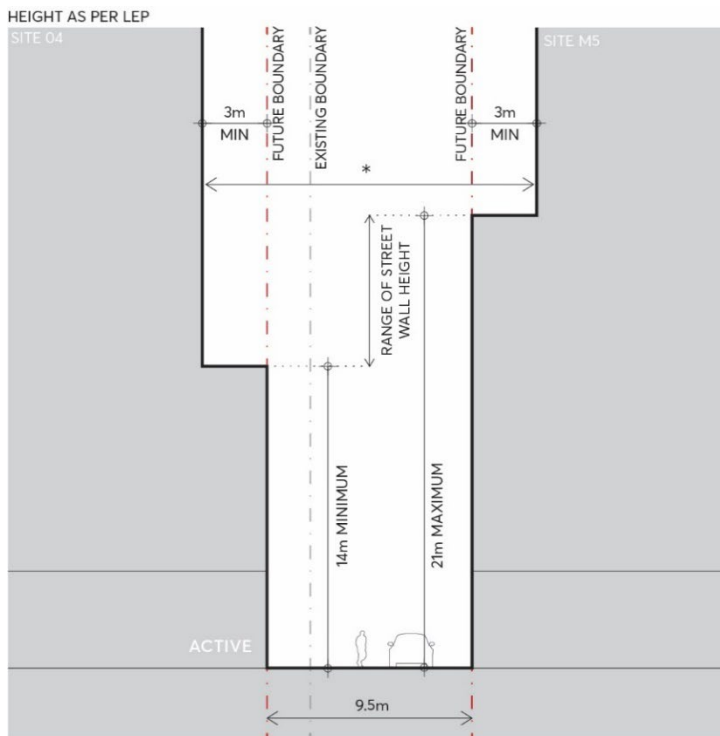

Figure 9.5.2.8 – Future Horwood Place (Section C) Setbacks & Street Wall Height

- f) Laneway setbacks and street wall heights on the new laneway to be provided between Site 04 and Site M5 must comply with Figure 9.5.2.9 (Section B). Development must provide a street wall built to the future boundary, and minimum 3 metres upper-level setback.



* SUBJECT TO BUILDING SEPARATION REQUIREMENTS

Figure 9.5.2.9 – New Laneway between Site 04 and Site M5 (Section B) Setbacks & Street Wall Height

- g) Laneway setbacks and street wall heights on Macquarie Lane must comply with Figure 9.5.2.10 (Section E). Development on the southern edge of Macquarie Lane must provide a building setback of 16 metres from the existing boundary of the Roxy to a 6 storey street wall with a 3 metres upper level setback to the tower. A maximum 4 storey Metro station structure may project into the 16m Macquarie Lane alignment with a separation of 7.5 metres for an open to sky pedestrian laneway between the Roxy and any station structure. The envelope, shown hatched in Figure 9.5.2.5 must align with the Roxy east and western wall and be below the height of the Roxy's roof at the rear theatre volume.

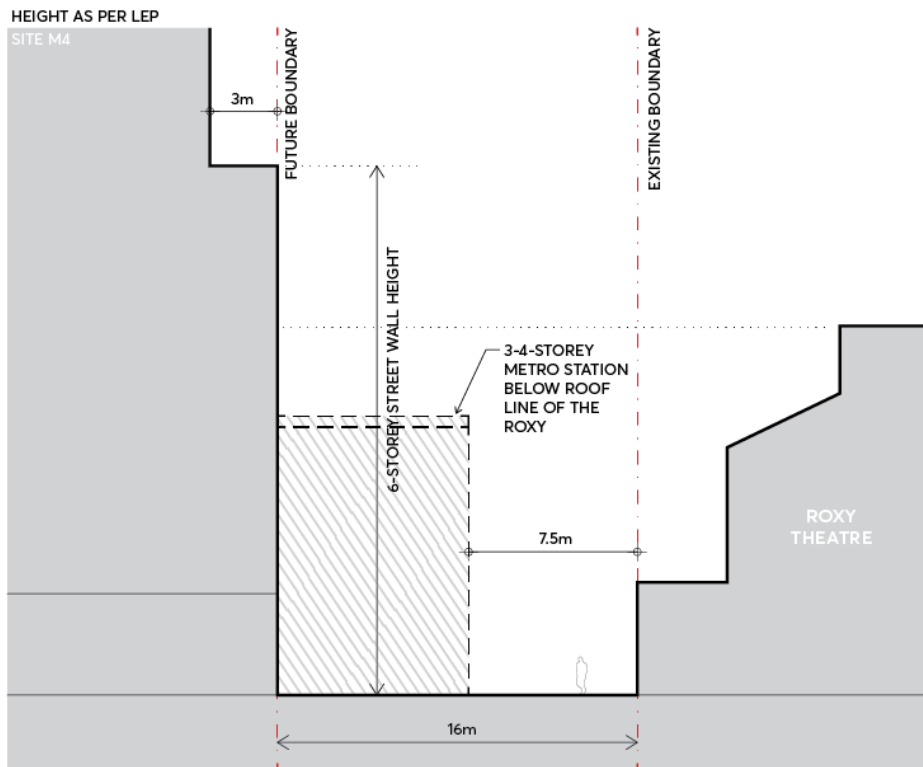

Figure 9.5.2.10 – Macquarie Lane (Section E) Setbacks & Street Wall Height

- h) At Site 05 street setbacks and street wall heights on Smith Street between George Street and Macquarie Lane must comply with Figure 9.5.2.5 and Figure 9.5.2.11 (Section G). Development must provide a 4 metre dedication for road widening to enable a pedestrian footpath; a 2 metres ground floor setback for use as additional pedestrian footpath; a maximum 8 storey street wall and a minimum 2 metres upper-level setback to the tower.

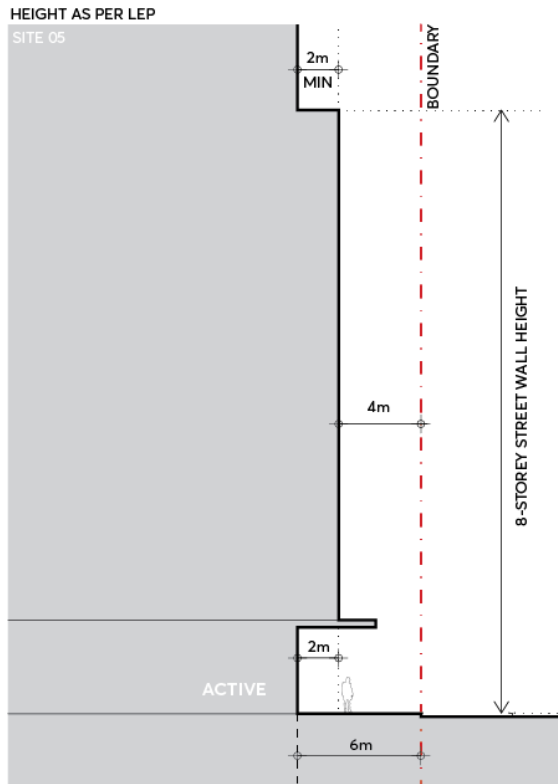

Figure 9.5.2.11 – 75 George Street at Smith Street (Section G) Setbacks & Street Wall Height

- i) Laneway setbacks and street wall heights on the new laneway to be provided between the Roxy and Site M5 must comply with Figure 9.5.2.12 (Section F). Development must setback 6.5 metres from the existing Roxy boundary, and minimum 3 metres upper level setback.
- j) Basement car park, service and loading entry and exit portals must be located on the New Laneway for Site 05 and are not supported on street frontages along George and Smith Street.
- k) Site access and traffic measures to properties within Block 2, including The Roxy and Site 05, must prioritise safe, pedestrian circulation and interchange between Smith Street bus corridor stops and the Metro station.

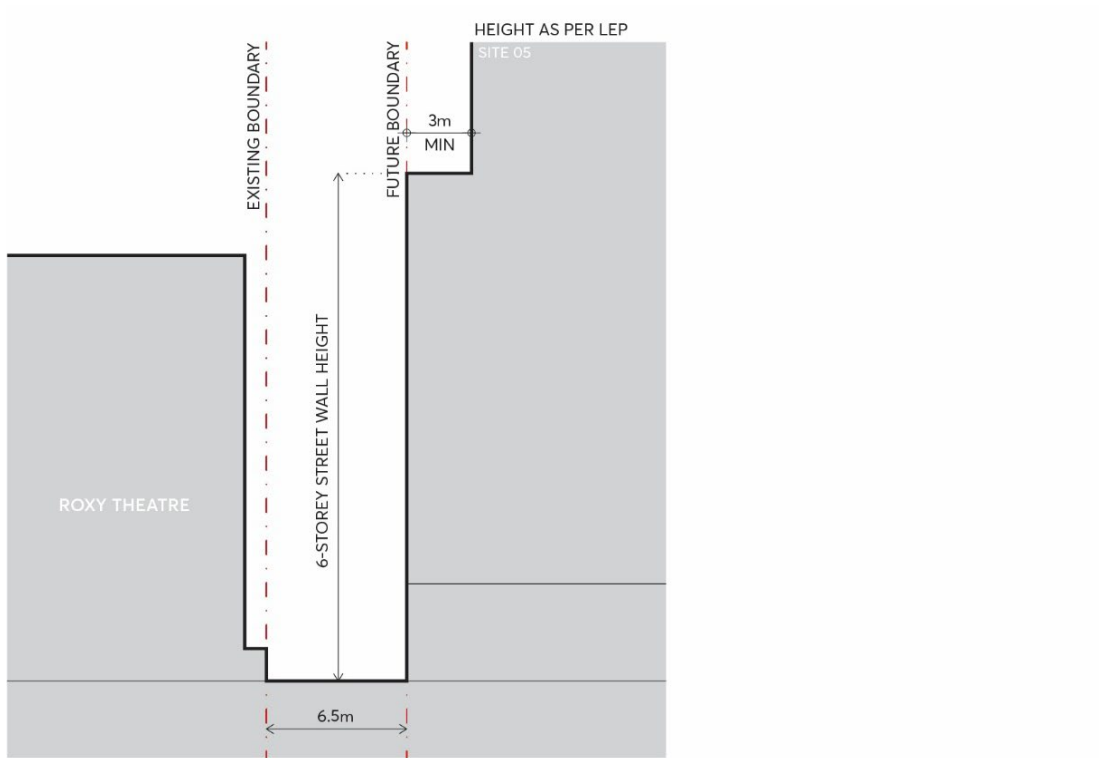

Figure 9.5.2.12 – New Laneway between the Roxy and Site 05 (Section F)

C.07 Development within Block 3 must comply with the following specified envelope controls:

- a) Along Civic Link, where street wall and tower buildings are proposed, a 3-5 storey/14-21 metre street wall height with an upper-level setback of 6 metres must be provided as indicated on Figure 9.5.2.13 (Section H)

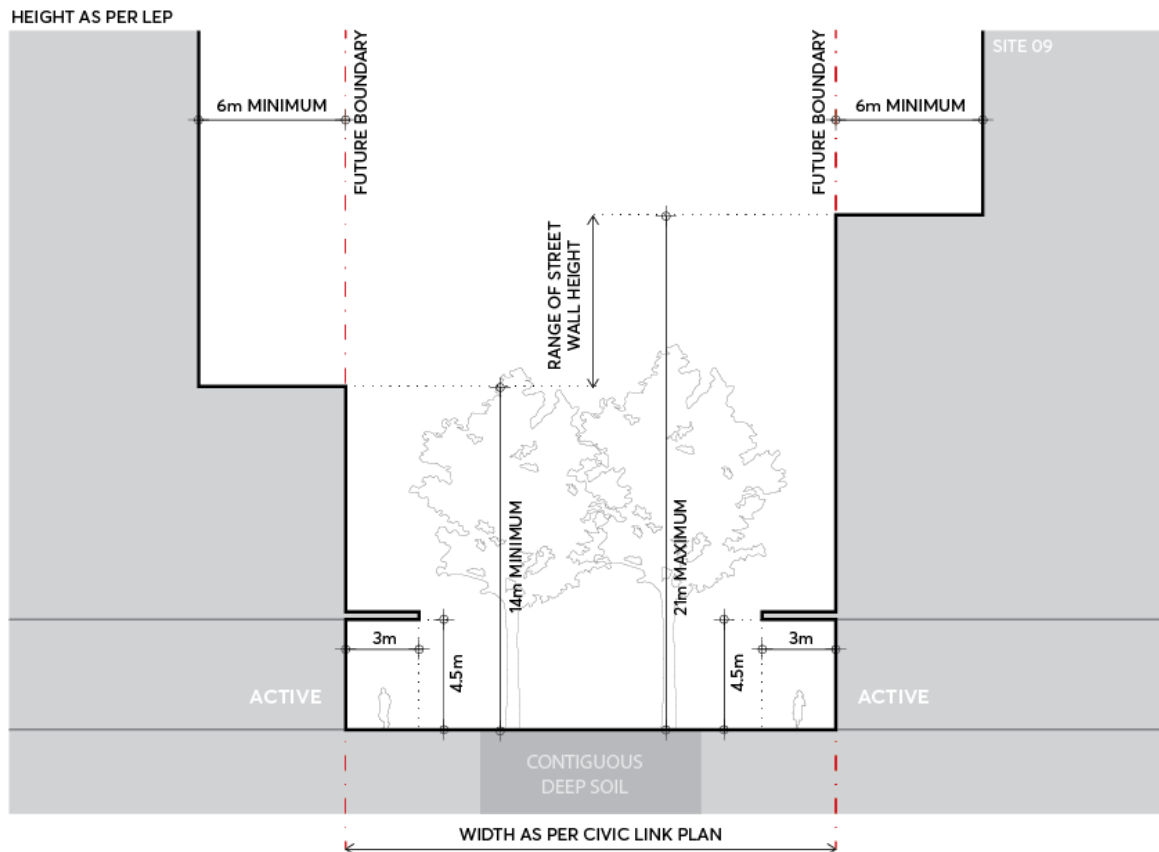

Figure 9.5.2.13 – Future Civic Link in Block 3 (Section H) Setback & Building Height

- C.08 A site specific DCP (SSDCP) must be prepared for the hatched area between George and Phillip Streets as indicated on Figure 9.5.2.4 to provide the following:
- A new north-south share lane or street that provides vehicle access to properties within the SSDCP area and along Church Street.
 - A new east-west pedestrian link or shared lane linking Civic Link to Church Street and the light rail stop.
 - Consolidated development footprints with address to Phillip Street or George Street and that enable CBD commercial towers, public carparking and/or cultural facilities.
 - A new square of 1000 sqm with direct frontage to Phillip Street.
- C.09 Along Civic link, development must provide continuous awnings with a clearance of 4.5 metres and a depth of 3 metres for all new buildings.
- C.10 Basement car park, service and loading entry and exit portals must be located on laneways or secondary streets and not on street frontages along Macquarie Street, George Street, Phillip Street and Smith Street, and along frontages to Civic Link.
- C.11 On-grade parking within private land is prohibited. All car parking within buildings must be concealed from the public realm or located in basements beneath the building footprint.
- C.12 Underground car parking must not extend under Civic Link, streets, laneways and public spaces. Structures underground may be considered, where limited in width and used only for the

underground metro station, basement associated with transport infrastructure operations, and for vehicle circulation between basements located under buildings. This is subject to demonstrated achievement of the following public domain outcomes:

- a) contiguous soil volumes within the extents shown in Figure 9.5.2.5 and with a minimum 1.8 metres set down including drainage layers and a minimum 1 metre of soil, and excluding slab structures,
 - b) utilities which are accessible from above ground. Suspended utilities within basements are prohibited,
 - c) water sensitive urban design swales and garden beds flush and/or below pavement level, and
 - d) adequate building structure and public domain fixtures to support large trees and vehicle loads for service and emergency vehicles.
- C.13 Public domain fixtures and finishes must comply with [Parramatta Public Domain Guidelines](#) and Technical Standards.
- C.14 Emergency fire access, stabiliser and vehicle passing requirements must be confirmed at concept design stage or pre-DA equivalent.
- C.15 Overland flow waters must be diverted away from the Civic Link.
- C.16 Developments must seek to adaptively re-use heritage buildings within the Special Area for community facilities, entertainment uses and cultural uses.
- C.17 Along Civic Link development must include direct access to ground floor and first floor tenancies with commercial lobbies primarily accessed from Macquarie, Smith, George and Church and New Horwood Place.
- C.18 Walls between tenancies on ground and first floors in buildings along Civic Link must be non-load bearing to enable flexibility in tenancy shape and area over time.
- C.19 Buildings along Civic Link must be designed with appropriate acoustic amenity for a live music and event environment.

9.5.3 GEORGE STREET

The Colonial township of Parramatta was planned in 1790, and its main street (George Street, formerly High Street) was Sydney's first formalised street. Originally planned at 200 feet (60 metres) wide, spanning east-west from Government House to the public wharf, George Street was one of the primary axes in Parramatta's original Georgian Town Plan. To accommodate a rapidly growing population, the second stage of Parramatta's planning occurred in 1811, when George Street was resized to its present 20 metres width.

Today, George Street still holds significant historic value, starting at the Tudor Gates entrance to Parramatta Park, crossing a range of areas in the City Centre including the Justice Precinct, Church Street, the future civic link, and terminating with parklands at either end.

There is an existing architectural character along George Street as an outcome of remnant heritage items set among the more recent urban and commercial development. Generally, these items date from the nineteenth and early twentieth centuries, representative of a variety of colonial and

Victorian architectural styles such as Harrisford House and Perth House. Significant inter-war redevelopment is also represented by noted buildings such as the Roxy, the former Rural Bank building and the Civic Arcade.

The tower setback control for George Street correlates with the 12 metres Height of Building limit on Church Street, emphasizing George Street and Church Street as the primary east-west and north-south streets in the City Centre, refer Figure 9.5.3.1. The tower setback control for George Street assists in preserving the spatial significance of its axis, as well as maintaining views to Parramatta Park, specifically the Tudor gates which terminate views to the west.

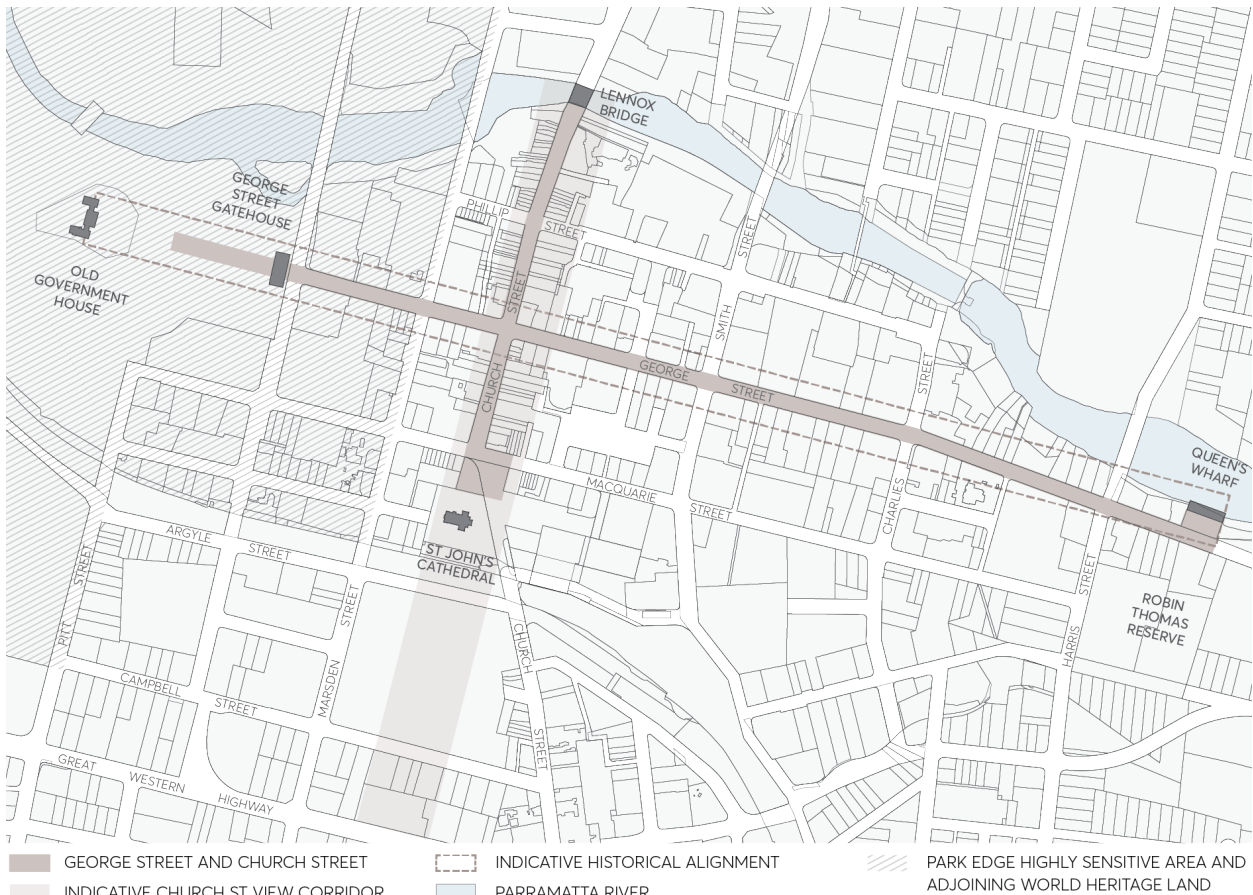

Figure 9.5.3.1 – George Street and Church Street View Corridor

Objectives

- O.01 Strengthen the framing of George Street by providing a consistent street wall alignment and generous upper level setbacks. Allow views and vistas to reinforce the civic significance of George Street, defining and framing the view east from the George Street Gatehouse and west toward the George Street Gatehouse.
- O.02 Ensure the protection and interpretation of Parramatta’s significant heritage setting and recognise the UNSCO importance the original direct line of George Street (formally High Street) connecting Old Government House and Queens Wharf as a nationally significant cultural landscape.
- O.03 Conserve heritage frontages to the highest standard and preserve existing fine grain activation. Maintain all existing open spaces, forecourts or associated curtilage collocated with heritage

items along George Street and support the revitalisation of individual squares through upgrades to public domain and canopy planting.

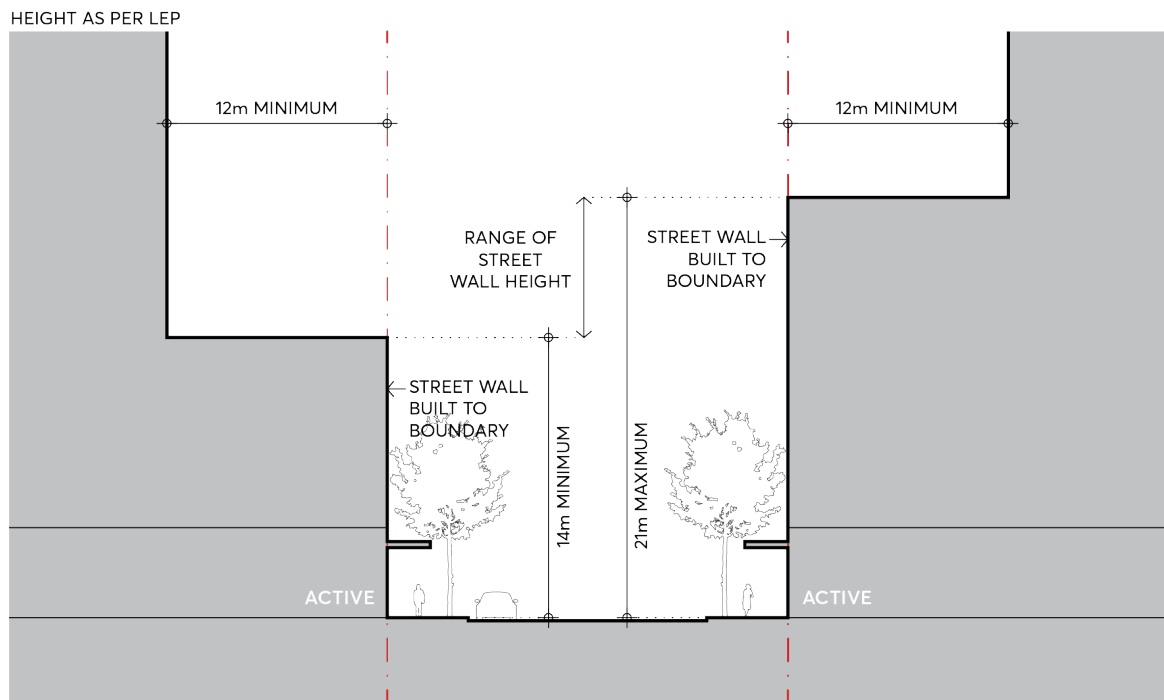

Figure 9.5.3.2 – George Street Special Area Framework Plan

Controls

Unless modified or specifically excluded below, all controls in Sections 9.1 - 9.4 and Sections 9.6 - 9.9 of the City Centre controls apply to development within the George Street Special Area.

- C.01 The street wall must be built to the street boundary a minimum of 14 metres and a maximum of 21 metres above the footpath level as per Figure 9.5.3.3. Where identified, a dedication for future footpath widening and cycleway is to be provided at ground, consistent with the Land Acquisition Reservation Map.
- C.02 Where identified in Figure 9.5.3.2 towers above the street wall must be set back a minimum of 12 metres from the street boundary, as per Figure 9.5.3.3, reinforcing the historical significance, views, alignment, and status of the street.



REFER TO LAND RESERVATION ACQUISITION MAP TO DETERMINE GROUND FLOOR INTERFACE

Figure 9.5.3.3 – George Street - Street Setbacks and Street Wall Height

- C.03 Building alignments and setbacks should respond to important elements of the nearby context including existing forecourts and heritage buildings. In some places, this may require greater setbacks or lower street wall heights than those specified in Figure 9.5.3.3.
- C.04 Retain forecourts of heritage items which interpret the historic alignment of George Street, including Perth House, Brislington, and the Roxy Theatre.
- C.05 Adaptively re-use and integrate heritage buildings as part of site development strategies, allowing these items to contribute to an active streetscape character and maintain their significance.
- C.06 Refer to Section 9.5.2 – Civic Link Special Area for requirements relating to developments adjoining the Civic Link Special Area. Where there is a conflict between the George Street controls and Civic Link controls, the Civic Link controls will prevail.
- C.07 Refer to Section 9.5.10 – Park Edge Highly Sensitive Area for requirements relating to developments on George Street between Parramatta Park and Marsden Street that fall within the Old Government House and Domain UNESCO heritage protection area.

9.5.4 CHURCH STREET

The Church Street Special Area is located between Lennox bridge to the north and the civic spaces at Centenary Square and St John's Cathedral to the south. Part of the original colonial town layout, Church Street today is the most active street in the city. Development must take care not to erode its evolved character, its vitality, grain and scale. Church Street forms the historic north-south spine of the city, and George Street, although different in character, is its east-west equivalent. Refer Figure 9.5.3.1.

Surviving views and vistas of St John's Cathedral have state historical significance. These include: east along Hunter Street to the Cathedral towers; east from Hunter Street across the northern Cathedral grounds towards the Town Hall and the site of the Governor's annual 'feast' with Aboriginal clans (instituted by Governor Macquarie) that took place at the rear (eastern end) of the Cathedral, and views from Church Street towards St John's Cathedral.

A consistent maximum building height along the entire axis of Church Street up to the Cathedral is applied to help preserve these views. The view corridor widens south of Macquarie Street to capture the spatial scale of Centenary Square and the grounds to St John's Cathedral. The most enduring and arguably most important civic space in Parramatta City Centre, the built elements that provide curtilage to this space must provide a sense of enclosure that is appropriately scaled.

As Church Street transforms with the development of the City Centre, its special identity must be retained and reinforced. Development must respond to and incorporate its fine grain, human scale, and active pedestrian character.

Objectives

- O.01 Preserve the Church Street view corridor identified in Figure 9.5.4.1 to elevate the spatial significance of Church Street and views to St John's Cathedral, protecting the silhouette of the St John's Cathedral spires as seen against the sky from Church Street as well as the procession and views from St John's Cathedral northwards, up Church Street.
- O.02 Strengthen the framing of Church Street by providing a consistent street wall alignment and consistent building height limit as required by the Height of Buildings Map in *Parramatta LEP 2023* and Figure 9.5.4.2. Allow views and vistas to reinforce Church Street's civic significance, defining and framing the view south from the River towards St John's Cathedral.
- O.03 Preserve the low rise setting of Centenary Square created by the existing 2 to 3 storey heritage items that flank it as shown in Figure 9.5.4.2 to protect the heritage relationship between these buildings and their unique framing of Centenary Square.
- O.04 Adaptively re-use heritage to foster the continuation of a fine grain character for Church Street. The street wall and ground floor design of development proposals must incorporate the active, fine grain subdivision pattern of Church Street, enabling sensitive urban infill that also compliments the remnant heritage along the street corridor.
- O.05 Strengthen and support the distinct outdoor dining character of Church Street, reinforcing its unofficial identity as Parramatta's 'Eat Street'.

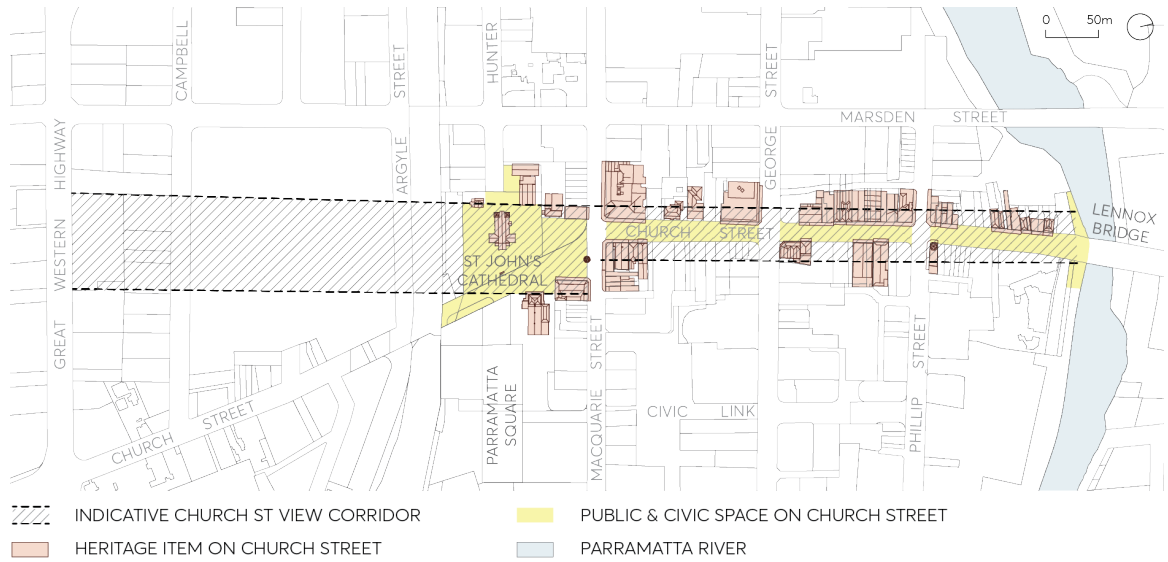

Figure 9.5.4.1 – Church Street View Corridor and Centenary Square

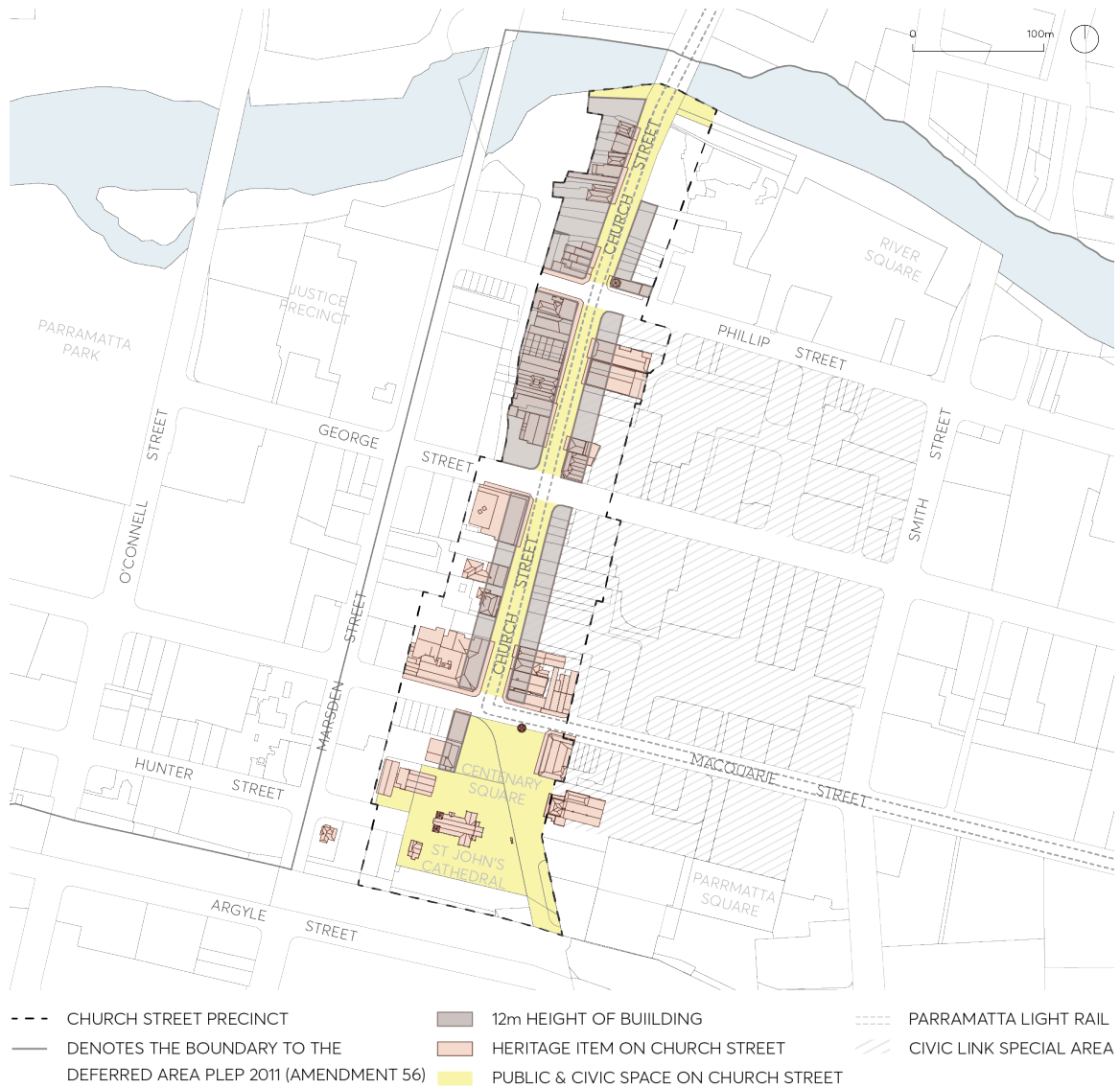

Figure 9.5.4.2 – Church Street and Centenary Square Framework Plan

Controls

Unless modified or specifically excluded below, all controls in Sections 9.1 - 9.4 and Sections 9.6 - 9.9 of the City Centre controls apply to development within the Church Street Special Area.

- C.01 Street wall heights and street setbacks must comply with Figure 9.5.4.3. The street wall must be built to the street boundary and are encouraged to be at or close to the 12 metres in height. Towers above the street wall must be set back in accordance with the Height of Buildings Map in the *Parramatta LEP 2023*.

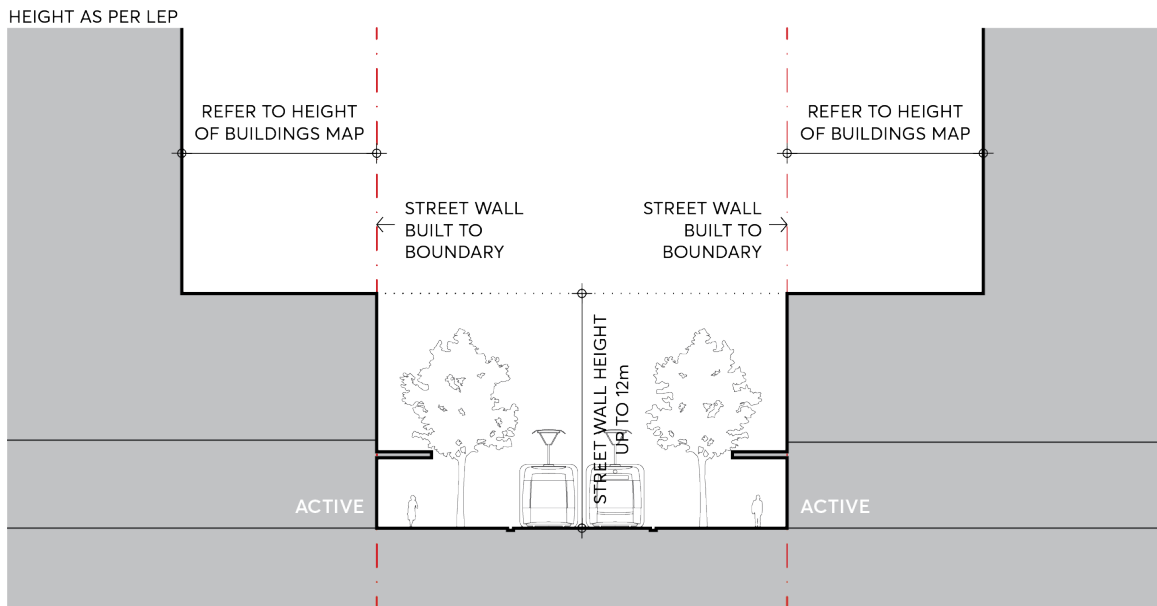

Figure 9.5.4.3 – Church Street - Street Setbacks and Street Wall Height

- C.02 Tower development is prohibited within the Church Street view corridor, as indicated in Figure 9.5.4.1, to preserve views down Church Street and the silhouette of St John’s Cathedral seen against the sky, reinforced by the Height of Buildings Map in *Parramatta LEP 2023*.
- C.03 Fine grain tenancies must be designed at the ground floor along Church Street, allowing for maximum 6 metres wide tenancies. All retail tenancies fronting Church Street must have primary entrances addressing Church Street.
- C.04 Refer to and comply with City of Parramatta’s ‘Church Street Colour Scheme Volumes 1 and 2’.

9.5.5 MARION STREET

The Marion Street Special Area is located toward the southern fringes of the Parramatta City Centre. The Eastern edge of the Special Area is directly next to the railway line which bisects Marion Street. Harris Park Train Station is located within walking distance towards the south-east, and the precinct interfaces with Auto Alley to the West, a major pedestrian and vehicular corridor. Jubilee Park is the closest public open space, and to the South, Marion Street is bounded by the Station Street West Special Area. A Council owned carpark is situated within the north-east block and site-specific controls apply to the site at 33-43 Marion Street.

Marion Street consists primarily of low scale built form including several heritage cottages clustered within the central area of the street. While the buildings in the precinct vary in their style, scale, age and use, the surviving heritage cottages still maintain a consistent form, relationship to each other and to the street. They also have a spatial quality that contrasts the existing and potential future scale and form of the City towards this fringe. This collective value created by the heritage items adds to the significance of Marion Street as a Special Area.

The following Special Area controls for the precinct ensure that a more localised and heritage led response to the desired character of this street will be achieved and that heritage items are given longevity and a chance for integrated adaptive reuse as urban renewal of the area takes place.

Future built form must achieve a measured response to the existing developments within the surrounding built context and provide for the desired activation, pedestrian connectivity and amenity within the precinct.

Objectives

- O.01 Conserve heritage buildings to the highest standard and activate street frontages through both the adaptive reuse of heritage items as well as the provision of active ground floor spaces within and around the heritage buildings.
- O.02 Integrate heritage buildings as part of an overall site development strategy that achieves pedestrian interconnectivity and site permeability around the heritage buildings, resulting in a fine network of intimate streets and laneways in the area.
- O.03 Enhance the traditional setting of heritage items with the retention and restoration of gardens, fences and paths associated with the buildings, reflecting the vegetated, intimate and eclectic character of Marion Street.
- O.04 Implement a built form approach that places massing away from the street, behind heritage items, and ensures separation between heritage buildings and new development to maximise site permeability, connectivity with the public realm, transition of scale, views to sky and opportunity for solar access to the street and surrounding developments.
- O.05 Improve legibility and pedestrian connections within the precinct by achieving a permeable ground plane with visual and physical connectivity through the blocks in accordance with Figure 9.5.5.1 - Marion Street Special Area Framework.
- O.06 Achieve an appropriate consolidation pattern in accordance with Figure 9.5.5.2 that allows the principles and objectives of the Marion Street Special Area to be integrated into development proposals.

- O.07 Maintain the existing heritage grain and pattern at street frontages along Marion Street through a generally low street wall and lower level massing approach to infill development in accordance with Figure 9.5.5.3.
- O.08 Create a scale transition corridor along Marion Street that enhances solar access and views to sky by ensuring taller portions of massing are set back behind heritage items away from the main street with appropriate separation, ground plane permeability and interface with heritage buildings.

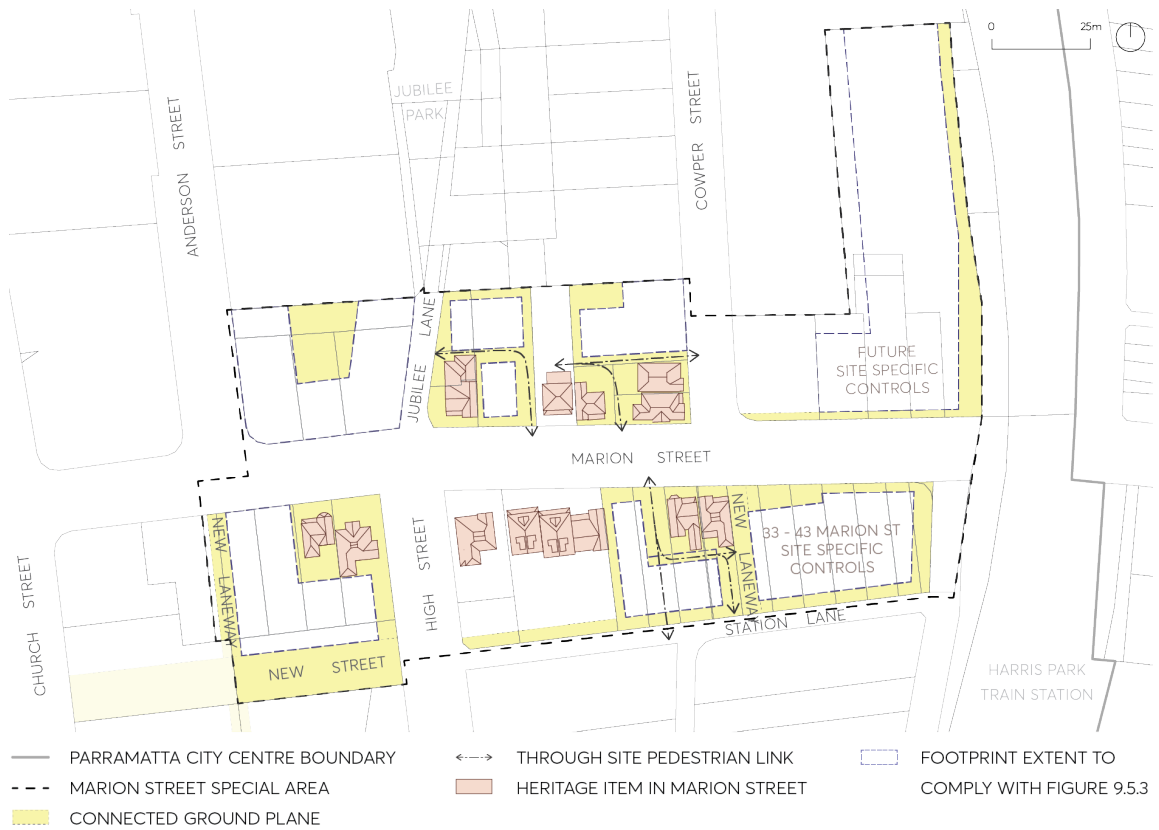
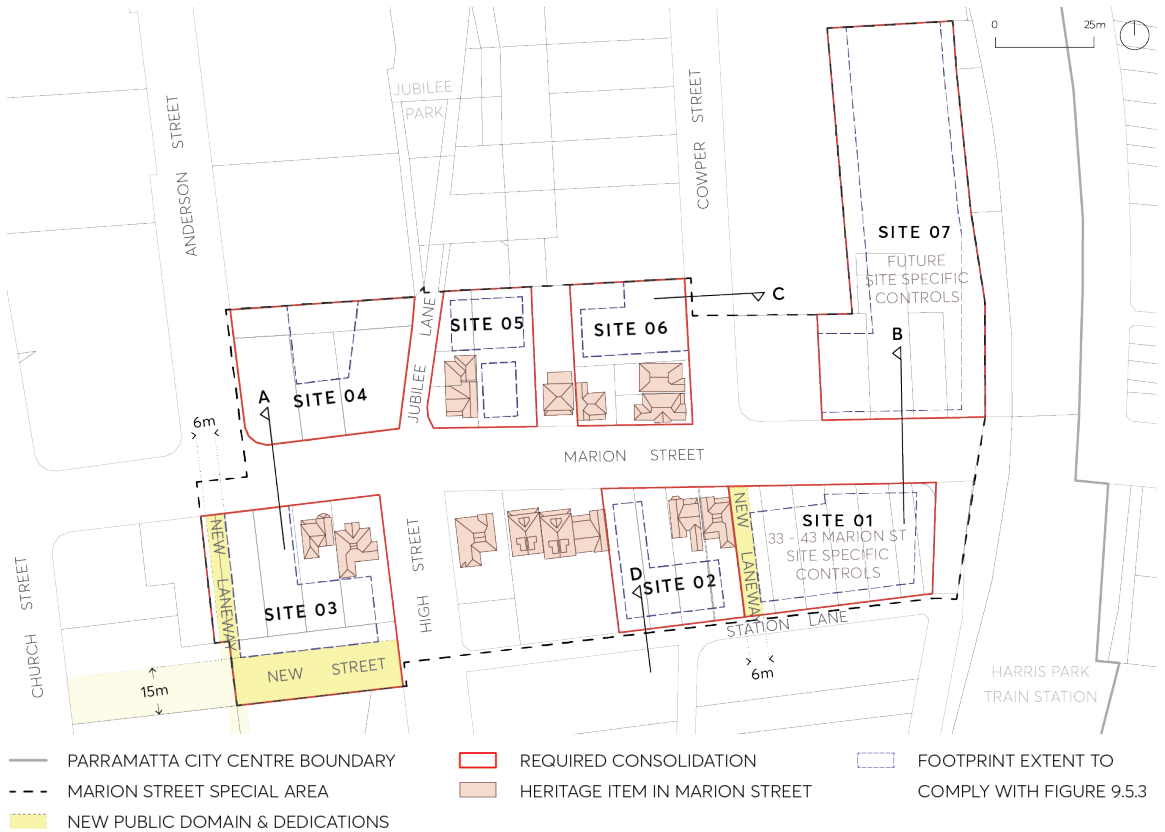

Figure 9.5.5.1 – Marion Street Special Area Framework



Controls

Unless modified or specifically excluded below, all controls in Sections 9.1 - 9.4 and Sections 9.6 - 9.9 of the City Centre controls apply to development within the Marion Street Special Area.

- C.01 Site consolidation must comply with Figure 9.5.5.3.
- C.02 Deliver new laneways, links and integrated pedestrian networks identified in Figure 9.5.5.1 through the inclusion of these elements in the plans for any proposed development within the precinct.
- C.03 Development within the precinct must comply with the following specified envelope controls:
- Street setbacks and street wall heights on Marion Street, west of High Street, must comply with Figure 9.5.5.3 and Figure 9.5.5.4 (Section A). On the southern side of Marion Street, the street wall must be built to the boundary for 3-storeys and towers set back a minimum 6 metres from the street wall. On the northern side of Marion Street, development may provide a street wall building up to full height under the Height of Buildings Map in the *Parramatta LEP 2023*.

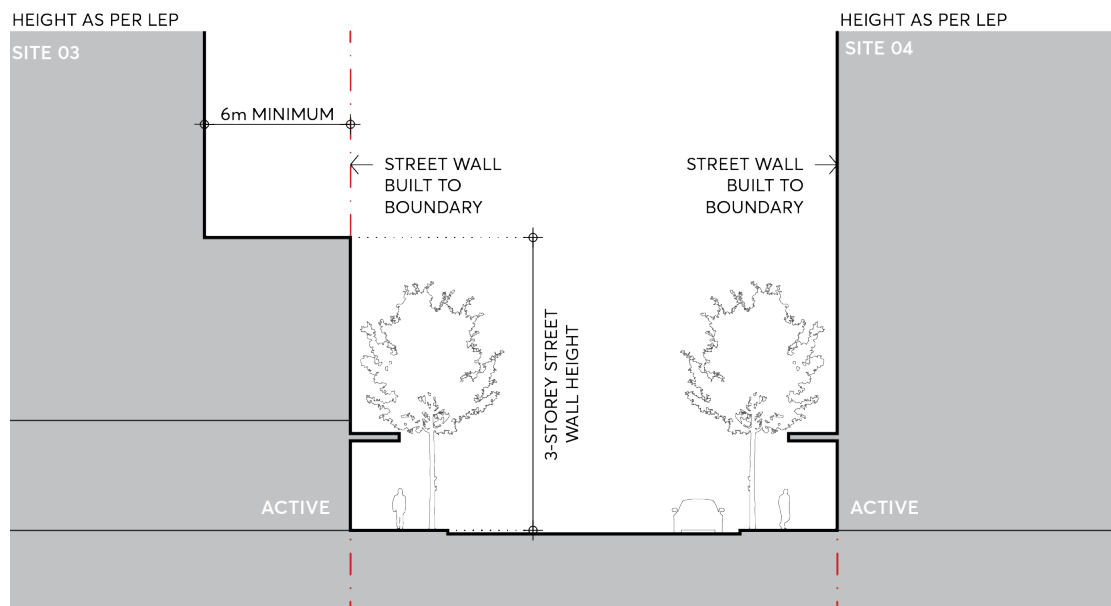

Figure 9.5.5.4 – Marion Street (Section A) Setbacks and Street Wall Height

- Street setbacks and street wall heights on Marion Street, east of Cowper Street, must comply with Figure 9.5.5.3 and Figure 9.5.5.5 (Section B). The street wall must be set back 3 metres from the street boundary and upper levels set back a minimum 6 metres from the street wall. Any development on the northern side of Marion Street must provide the 3 metre street wall setback, but will be subject to additional future site specific controls to determine upper level setbacks.

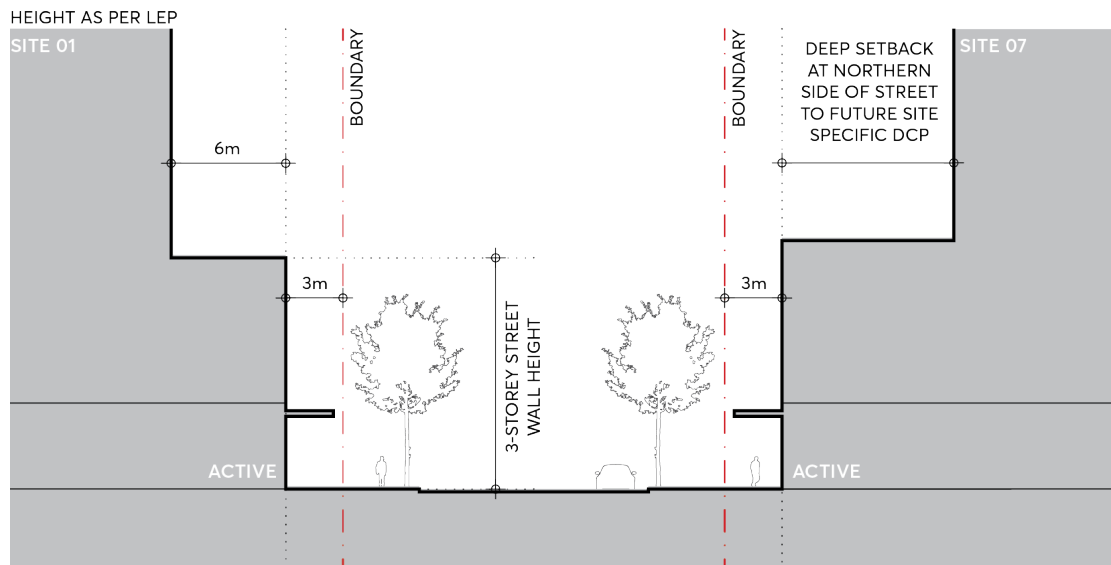

Figure 9.5.5.5 – Marion Street (Section B) Setbacks and Street Wall Height

- c) Street setbacks and street wall heights on Cowper Street must comply with Figure 9.5.5.3 and Figure 9.5.5.6 (Section C). The street wall must be built to the boundary up to 4-storeys and tower setbacks are to match the prevailing conditions.

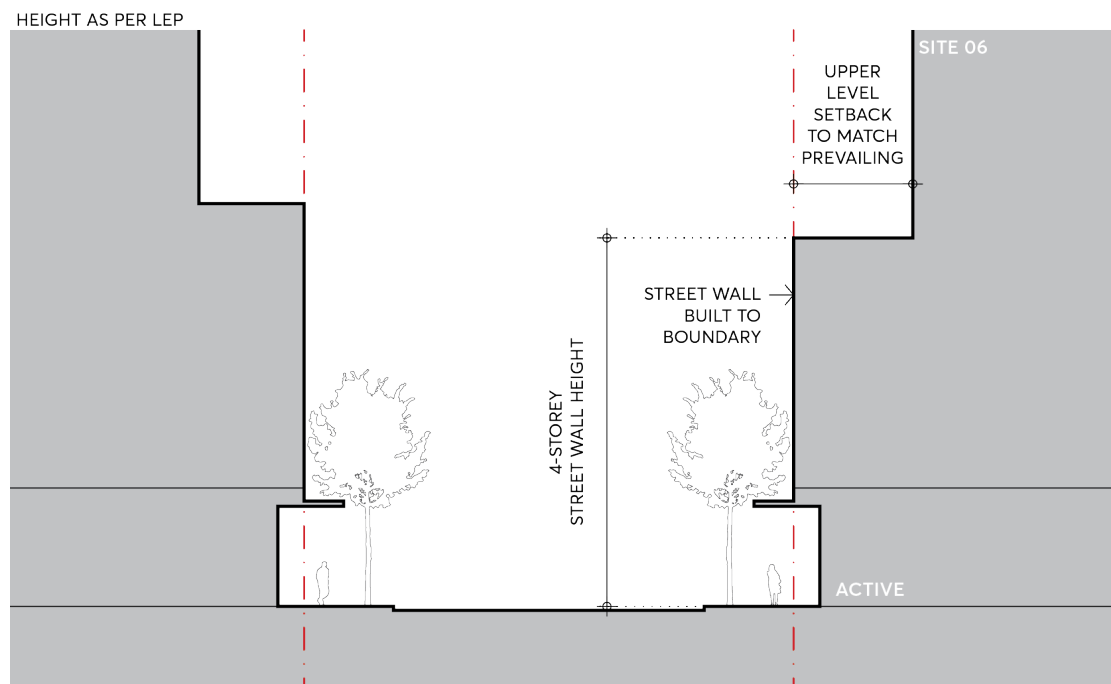

Figure 9.5.5.6 – Cowper Street (Section C) Setbacks and Street Wall Height

- d) Street setbacks on High Street must comply with Figure 9.5.5.3.
- e) Street setbacks and street wall heights on Jubilee Lane must comply with Figure 9.5.5.3.
- f) Street setbacks and street wall heights on Station Lane must comply with Figure 9.5.5.3 and Figure 9.5.5.7 (Section D). The street wall must be set back 4 metres from the laneway boundary and upper levels set back a minimum 2 metres from the street wall.

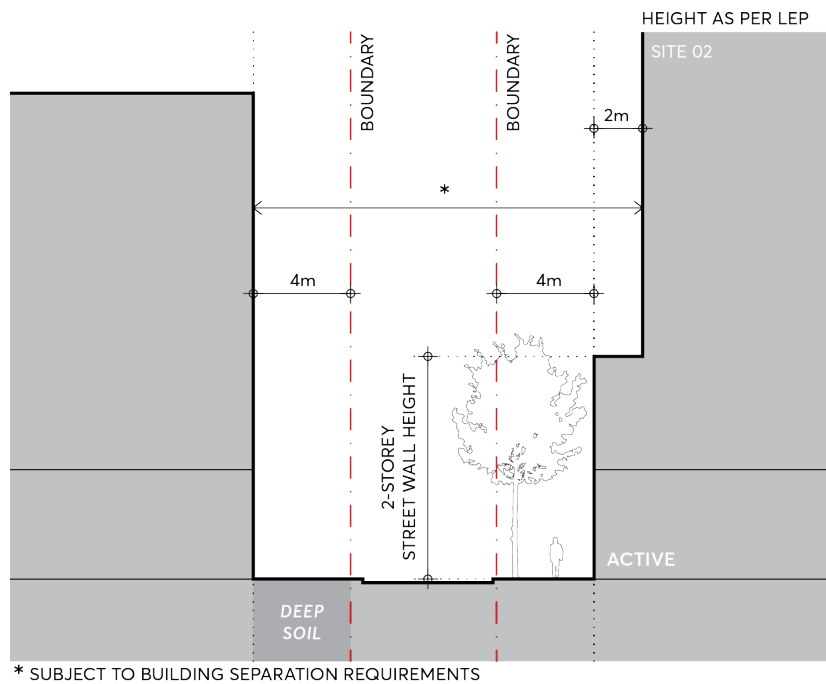

Figure 9.5.5.7 – Station Lane (Section D) Setbacks and Street Wall Height

- C.04 Buildings on vacant or infill lots where they are set between heritage items along Marion Street, and are not specified with a street setback dimension or height of building on Figure 9.5.5.2 – Marion Street Special Area Public Domain & Consolidation Plan or Figure 9.5.5.3 – Marion Street Special Area Required Setbacks & Built Form, must:
 - a) adopt a similar or matching setback to the adjacent buildings,
 - b) adopt a similar street width for built form unless a dimension is specified, and
 - c) be of a single or double storey form unless a maximum height in storeys is specified.
- C.05 Development within Site 07 must provide a contiguous area of deep soil in accordance with Figure 9.5.5.3.

9.5.6 CAMPBELL STREET & GREAT WESTERN HIGHWAY

The Campbell Street & Great Western Highway Special Area is located on the south-western edge of the City Centre, encompassing the state significant heritage grounds of St John's Cemetery. The area is characterised by its position at the periphery of the City Centre, proximity to Parramatta Park, diverse commercial and residential usage, and natural topographical cross-fall from the natural ridgeline of Great Western Highway.

Campbell Street is differentiated into two sections. Commercial development to the east between O'Connell and Church Street, and medium density residential blocks populate the western end of Campbell Street between O'Connell and Pitt Street. Campbell Street itself presents as a suburban street and most existing development has maintained 6m residential setbacks.

Future built form must also provide a measured response to the Church Street View Corridor (see Section 9.5.4 – Church Street Special Area for greater detail). State and local heritage listed items located within the precinct, as well as the established canopy trees located in the generous street setbacks of buildings fronting onto Campbell Street and Great Western Highway – regardless of their ground floor usage – constitutes a uniquely vegetated setback character to be preserved.

Objectives

- O.01 Preserve and reinforce the large canopy street trees and established planting character of the front setback zone of Campbell Street, Great Western Highway, Pitt Street and the perimeter of St John's Cemetery.
- O.02 Improve pedestrian amenity and public domain quality, acknowledging any potential street widening that may occur into the future.
- O.03 Apply an appropriate spatial definition on Campbell Street through a large building setback character to the street which recognises the increase in density.
- O.04 Conserve heritage items to the highest standard and ensure future built form does not adversely impact the amenity of St John's Cemetery, protecting its access to sunlight.
- O.05 Maintain a defined street wall for future development through consistent setbacks and strong sense of enclosure to St John's Cemetery.
- O.06 Elevate the spatial significance of Church Street and protect the silhouette of St John's Cathedral spires as seen against the sky from Church Street by delivering low, modest development within the identified Church Street View Corridor.
- O.07 Achieve an appropriate consolidation pattern that allows the objectives of the Campbell Street Special Area to be integrated into development proposals.

Controls

Unless modified or specifically excluded below, all controls in Sections 9.1 – 9.4 and Sections 9.6 – 9.9 of the City Centre controls apply to development within the Campbell Street and Great Western Highway Special Area.

- C.01 Site consolidation must allow for the realisation of the objectives of the Campbell Street Special Area and delivery of desired publicly accessible through site links as per Figure 9.5.6.1.



Figure 9.5.6.1 – Campbell Street & Great Western Highway Special Area Framework

C.02 Development within the identified Church Street View Corridor must not interrupt the views of the St John’s Cathedral Spires as seen against the sky from Church Street as per Figure 9.5.6.1 and 9.5.6.2. Refer to Section 9.5.4 – Church Street Special Area controls for further reference to the Church Street View Corridor.

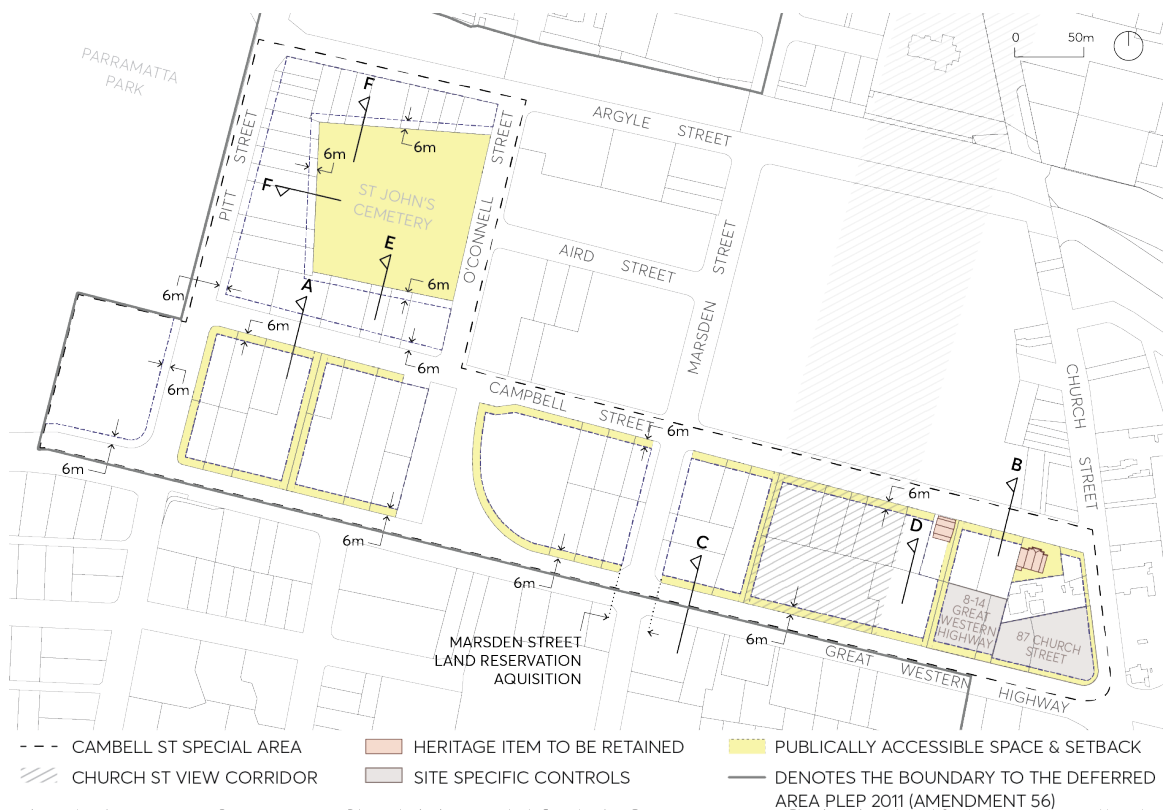

Figure 9.5.6.2 – Campbell Street & Great Western Highway Special Area Required Setbacks

C.03 Development must comply with the following street wall and setback controls:

- a) Street setbacks and heights on Campbell Street, west of O’Connell Street, must comply with Figure 9.5.6.3 (Section A). The street wall must be set back 6 metres from the street boundary and, on the southern side of Campbell Street, the tower must be set back a minimum 6 metres from the street wall.

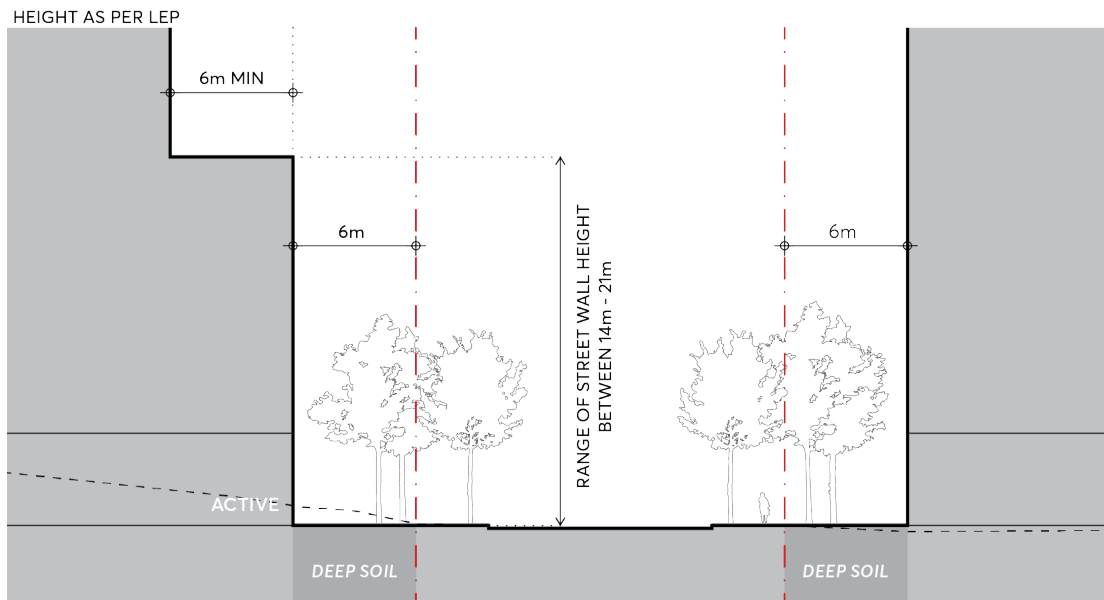

Figure 9.5.6.3 – Campbell Street (Section A) Setbacks and Street Wall Height

- b) Street setbacks and heights on Campbell Street, east of O’Connell Street, must comply with Figure 9.5.6.4 (Section B). On the southern side of Campbell Street, the street wall must be set back 6 metres from the street boundary and the tower must be set back a minimum of 6 metres from the street wall. On the northern side of Campbell Street, development may defer to Section 9.3 – Built Form section in this Part.

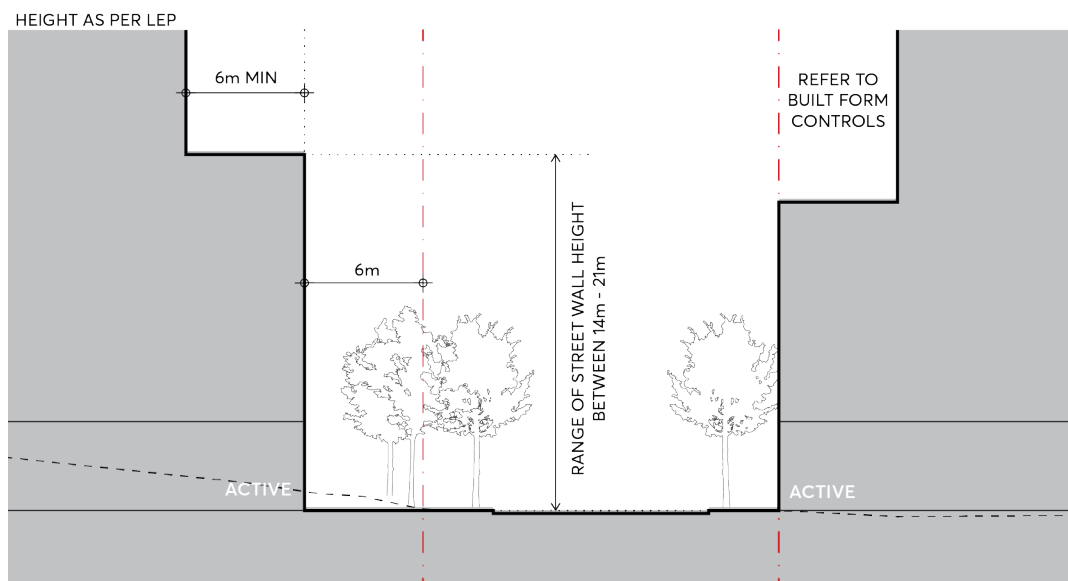
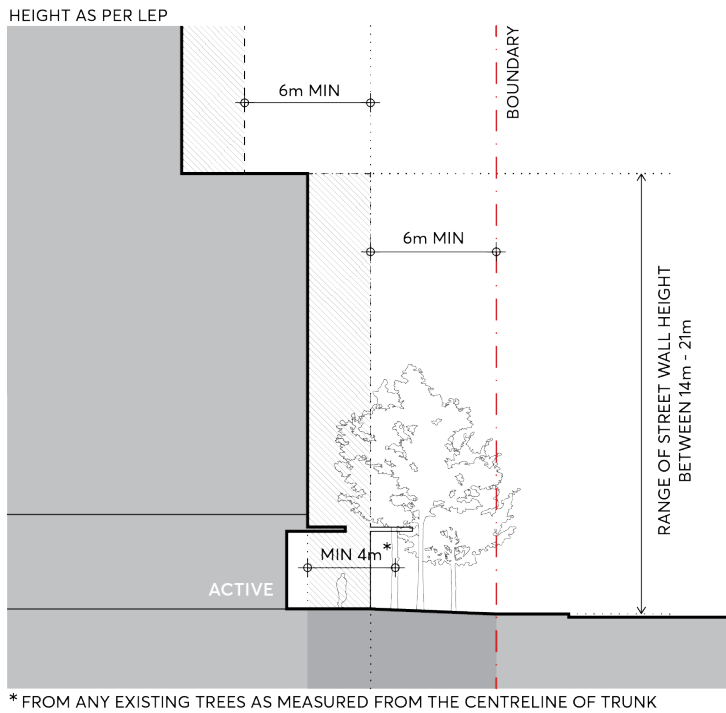

Figure 9.5.6.4 – Campbell Street (Section B) Setbacks and Street Wall Height

- c) Street setbacks and heights on Great Western Highway must comply with Figure 9.5.6.5 (Section C). The street wall must be set back a minimum of 6 metres from the street boundary and the tower must be set back a minimum of 6 metres from the street wall. Where an established tree is located within the front setback zone, development must ensure the street wall is set back a minimum of 4 metres from the centreline of trunk.



* FROM ANY EXISTING TREES AS MEASURED FROM THE CENTRELINE OF TRUNK

Figure 9.5.6.5 – Great Western Highway (Section C) Setbacks and Street Wall Height

- d) Development on Great Western Highway must provide a 6 metre landscaped setback to the street as detailed in Figure 9.5.6.6. This privately owned publicly accessible setback zone adjacent to active uses at ground is to be relatively level with existing kerb lines.

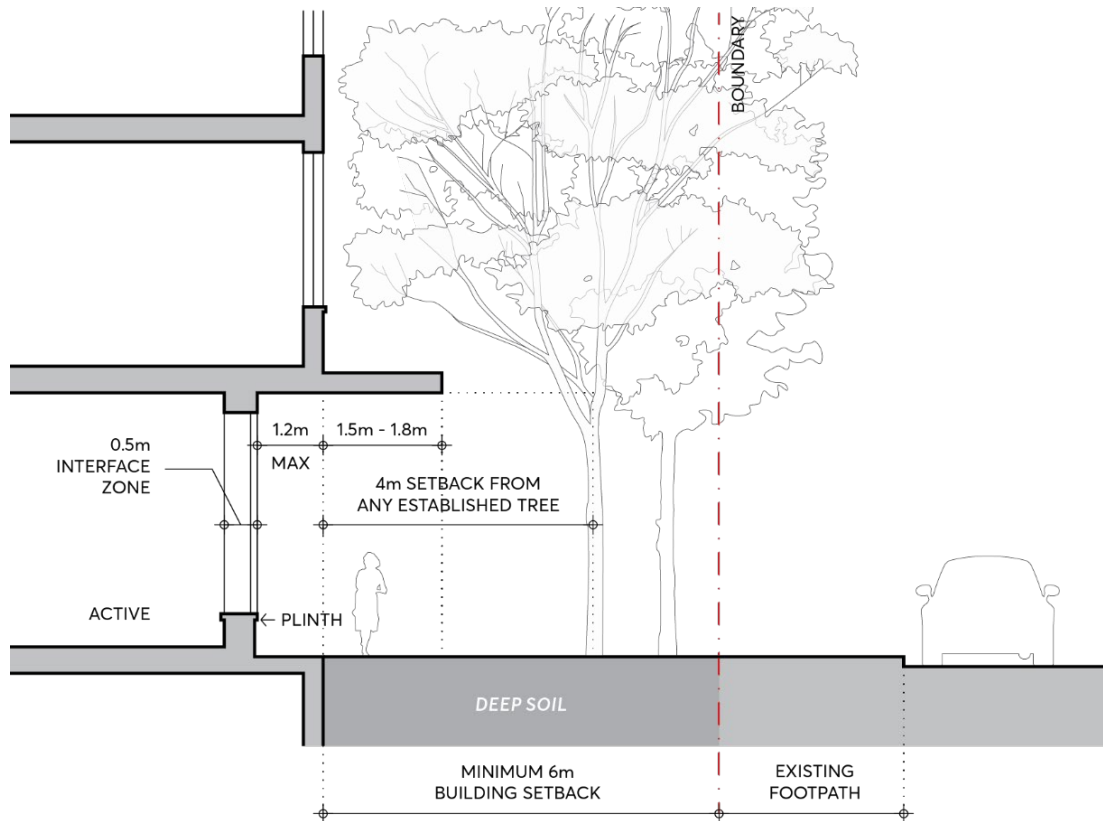

Figure 9.5.6.6 – Great Western Highway Ground Floor Interface

- e) A shared planting zone must be provided to the rear of lots between Campbell Street and Great Western Highway to comply with Figure 9.5.6.7 (Section D). A minimum 6 metre rear setback and soil depth allowance clear of any basement structure must be provided to Council's satisfaction to facilitate planting of large canopy trees. Towers must be setback a minimum of 9 metres from the rear boundary and comply with the building separation requirements in Section 9.3.3 of this Part of the DCP.

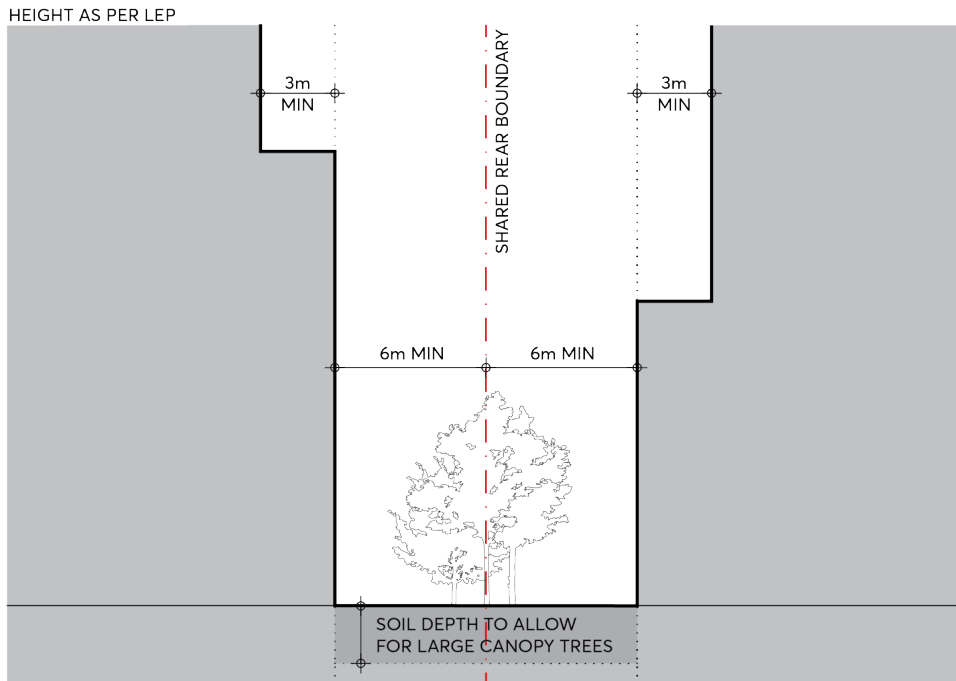

Figure 9.5.6.7 – Rear Setback (Section D) between Campbell Street and Great Western Highway

- f) Setbacks and building heights along boundaries shared with St John’s Cemetery must comply with Figure 9.5.6.8 (Section E) and 9.5.6.9 (Section F). Development must provide a building set back of 6 metres to any rear boundary shared with St John’s Cemetery and a further minimum 6 metre setback for towers.

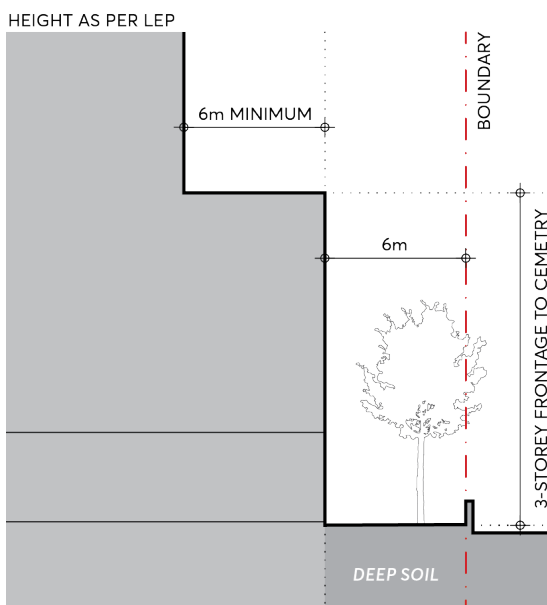

Figure 9.5.6.8 – Rear Setbacks (Section E) South of St John’s Cemetery

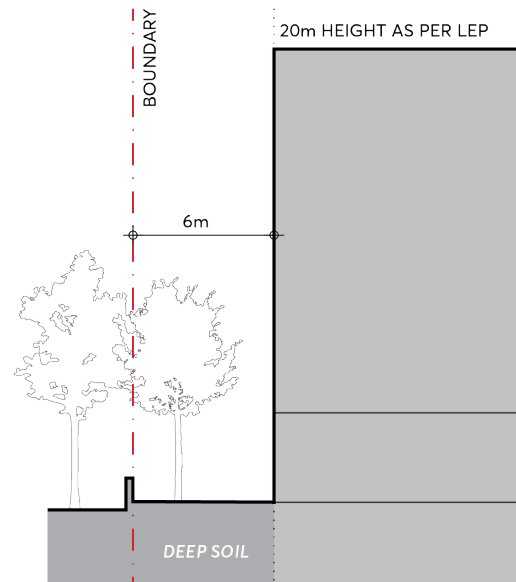

Figure 9.5.6.9 –Rear Setbacks (Section F) North and West of St John’s Cemetery

- g) Street setbacks on Pitt and Argyle Street must comply with Figure 9.9.6.2 and defer to Section 9.3.3 in this Part of the DCP.

- C.04 Deep soil is to be delivered within street setback zones and rear setbacks adjoining St John's Cemetery, provided with a minimum width of 6 metres.
- C.05 Where the street setback adjoins active uses, the setback zone is to be provided as a publicly accessible space, as per Figure 9.5.6.2. All stairs and ramps on active frontages must be internalised to ensure the public domain and front setback zones are kept relatively level, accessible and uncluttered.

9.5.7 AUTO ALLEY

The Auto Alley Special Area has been identified as a long-term growth area for the City. The future form of Auto Alley is proposed to retain the existing large retail tenancies on the street for automotive uses, while also providing an opportunity for commercial redevelopment in the long term. The controls for this precinct ensure a more localised response to the specific character established by the historical usage of south Church Street and the remnant commercial occupancies.

The Auto Alley Special Area must also deliver future open space for the City Centre and improve pedestrian connectivity in the south of the city. Approximately 1 hectare of park and plaza must be delivered alongside the redevelopment of Auto Alley. Several new streets must be provided: a north-south street is provided at the western boundary of the precinct; two east-west streets extend Dixon Street and Rosehill Street from Church Street to High Street; and a north-south lane extends Anderson Street from Marion Street to Raymond Street.

Built form must also consider the potential future development and public domain expected in the adjacent Marion Street Special Area to the north, and in the Station Street Special Area to the east. Specifically, the mixed-use eastern portion of the precinct must be considered as a transition area, as reflected in the lower building heights and FSR requirements in the *Parramatta LEP 2023*.

The controls for Auto Alley (West) which is made up of the land zoned E3 Productivity Support are contained in Part 9B.

Objectives

- O.01 Achieve an appropriate site consolidation that allows the *Parramatta LEP 2023* controls to be realised with appropriate built form and allows the best response to the existing heritage items and surrounding street and site geometries.
- O.02 Promote diverse commercial activity creating a complementary commercial core for the City Centre.
- O.03 Provide new open spaces to service the needs of resident and worker populations anticipated in the precinct.
- O.04 Enable large canopy trees to be planted in Church Street, enhancing the southern approaches to the City Centre, and improving the pedestrian environment along this busy section of the street.
- O.05 Increase precinct permeability with the delivery of new public streets, through site links and appropriate servicing commensurate with the density of the precinct.



Figure 9.5.7.1 – Auto Alley Special Area Public Domain & Consolidation

Controls

Unless modified or specifically excluded below, all controls in Sections 9.1 - 9.4 and Sections 9.6 - 9.9 of the City Centre controls apply to development within the Auto Alley Special Area.

- C.01 Site consolidation must comply with Figure 9.5.7.1 – Auto Alley Special Area Public Domain & Consolidation.
- C.02 Delivery, location and dedication of new streets, lanes and open spaces in the Auto Alley precinct must comply with Figure 9.5.7.1.
- C.03 Where specified, building envelopes must comply with Figure 9.5.7.2 to achieve the objectives highlighted for the Auto Alley Special Area.



Figure 9.5.7.2 – Auto Alley Setbacks and Indicative Built Form

C.04 Future development must comply with the following street setback controls:

- a) Street setbacks and street wall heights on Church Street must comply with Figure 9.5.7.3 (Section A). The street wall must be set back a minimum of 5 metres from the street boundary, and towers must be set back a minimum 6 metres from the street wall.

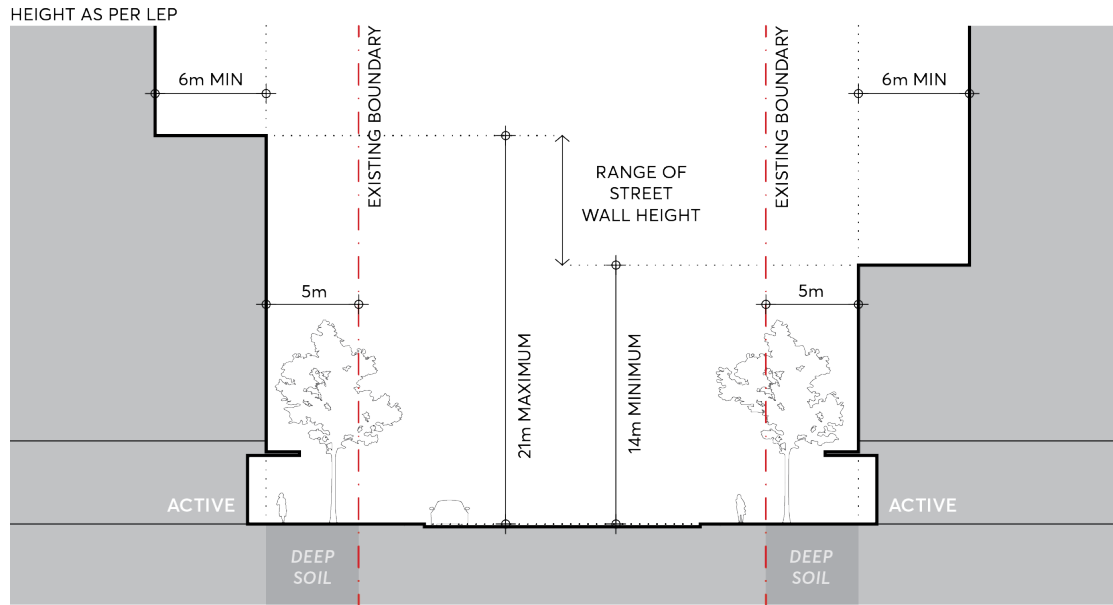

Figure 9.5.7.3 – Church Street (Section A) Setbacks and Street Wall Height

- b) Development on Church Street must dedicate a 5 metre setback to the street as detailed in Figure 9.5.7.4. This setback is to improve the pedestrian amenity and must be provided as deep soil free of any basement structures below.

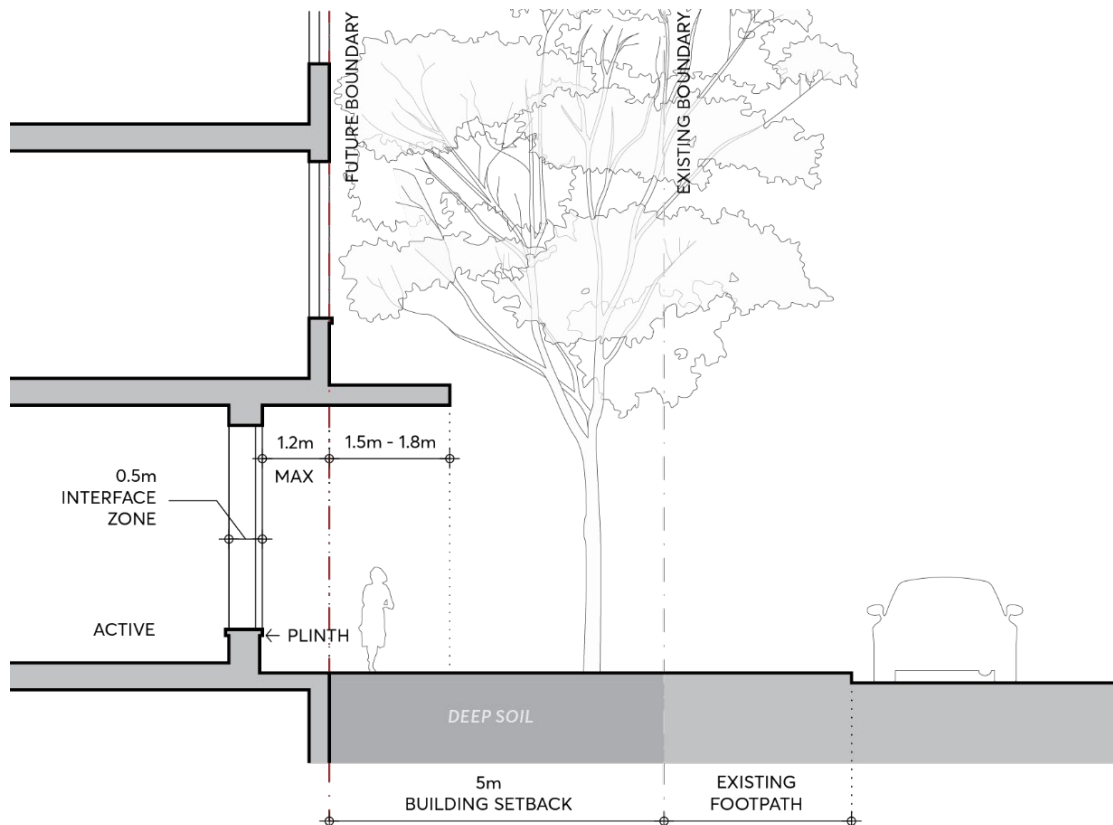

Figure 9.5.7.4 – Church Street Ground Floor Interface

- c) Street setbacks and street wall heights on Dixon Street must comply with Figure 9.5.7.5 (Section B). On the southern side of Dixon Street, the street wall must be built to the boundary and the tower set back a minimum of 6 metres from the street wall. On the

northern side of Dixon Street, the street wall must be set back 3 metres from the boundary and the tower set back a minimum of 6 metres from the street wall.

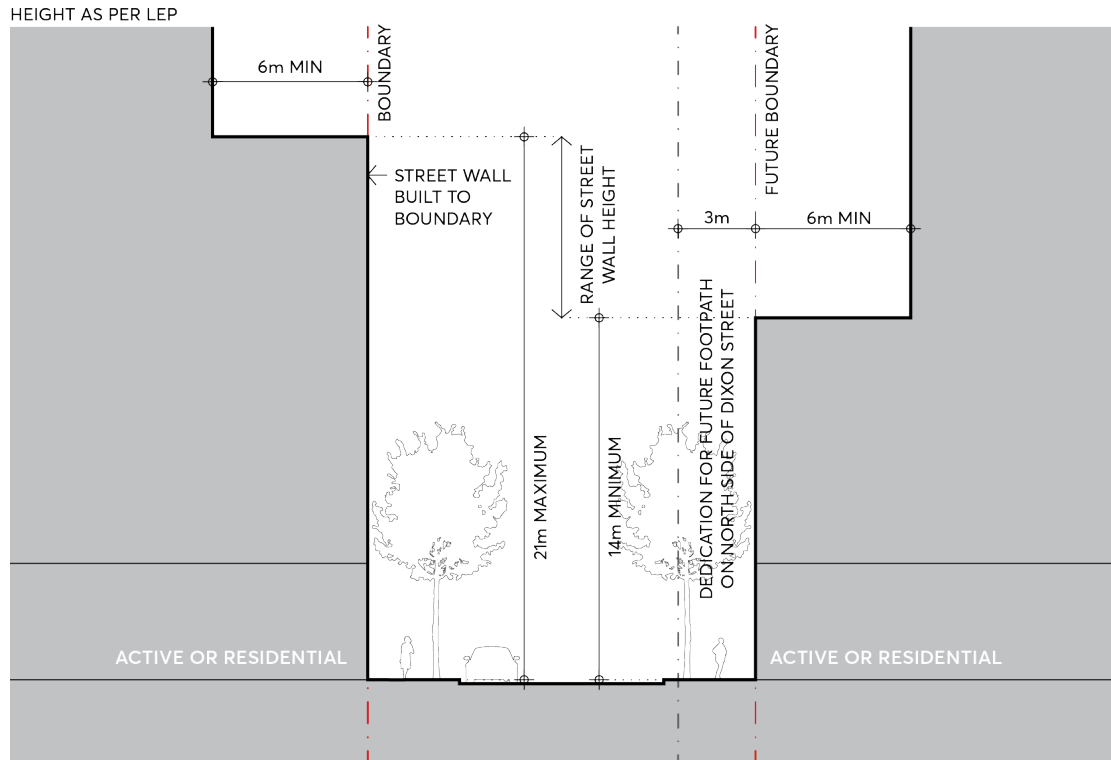
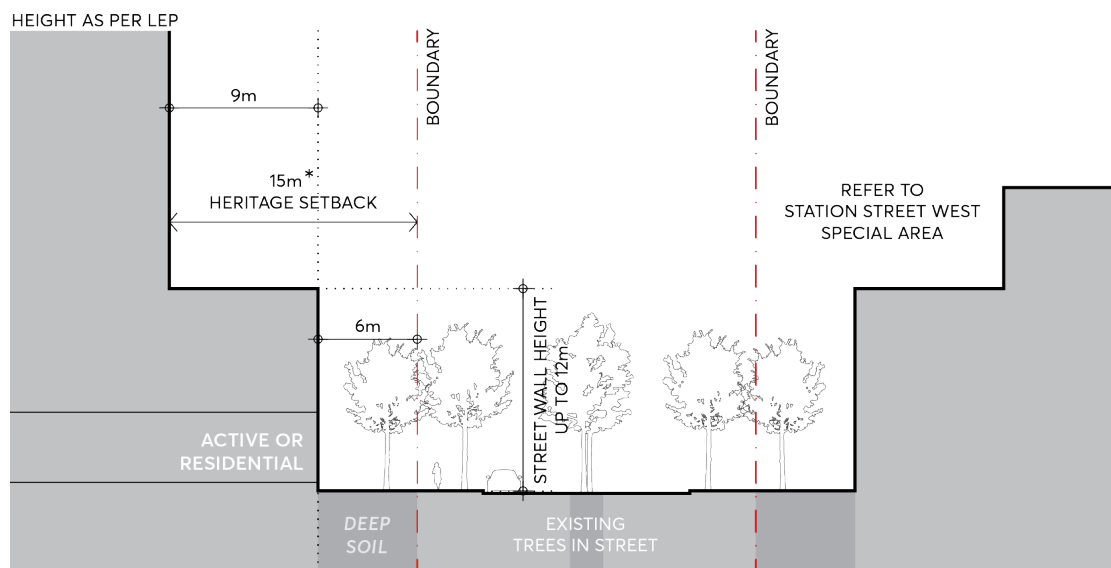

Figure 9.5.7.5 – Dixon Street (Section B) Setbacks and Street Wall Height

- d) Street frontage heights and setbacks on High Street must comply with Figure 9.5.7.6 (Section C). A 12 metre high street wall must be set back 6 metres from the street boundary. Towers must be set back 15 metres from the street boundary in accordance with the Height of Buildings Map in *Parramatta LEP 2023* to respond to adjacent heritage fabric.



* REFER TO HEIGHT OF BUILDINGS MAP

Figure 9.5.7.6 – High Street (Section C) Setbacks and Street Wall Height

- e) Where residential uses are being provided at ground on new streets identified in Figure 9.5.7.1, street setbacks and street wall heights of development must comply with Figure 9.5.7.7 (Section D). The building must be set back 6 metres from the street boundary to provide for private and communal landscaping, consistent with Section 9.3.5 – The Ground Floor.
- f) Where active uses are being provided at ground on new streets identified in Figure 9.5.7.1, street setbacks and street wall heights of development must comply with Figure 9.5.7.8 (Section D). The street wall must be built to the boundary and the tower must be set back a minimum of 6 metres from the street wall, consistent with Section 9.3.5 – The Ground Floor.

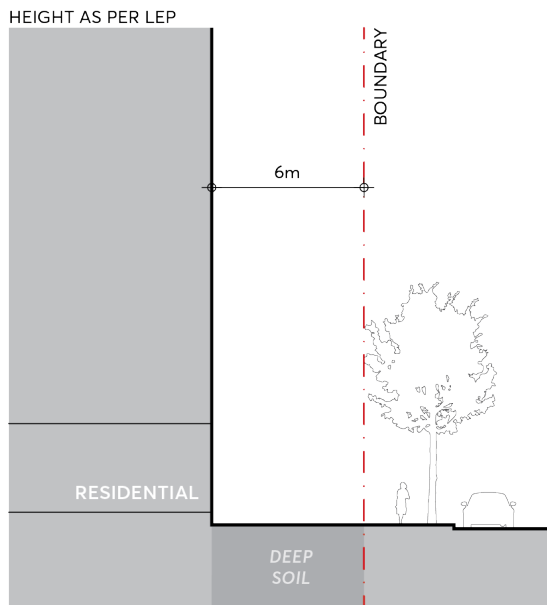

Figure 9.5.7.7 – New Streets (Section D)
Setbacks and Street Wall Height
Residential Ground Floor

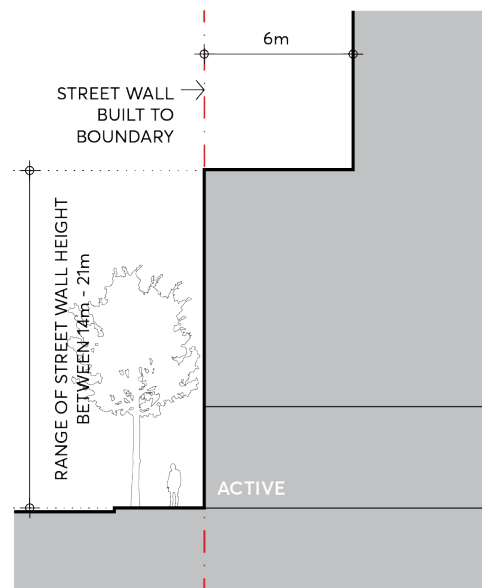

Figure 9.5.7.8 – New Streets (Section D)
Setbacks and Street Wall Height
Active Ground Floor

- g) Street setbacks and street wall heights on the future laneway connecting Marion Street to Boundary Street, as identified in Figure 9.5.7.1, must comply with Figure 9.5.7.9 (Section E). To the west, the street wall must be set back 3 metres from the future boundary and the tower set back a minimum of 3 metres from the street wall. To the east, the street wall must be set back 0.6 metres from the future boundary and the tower must be set back a minimum of 3 metres from the street wall.

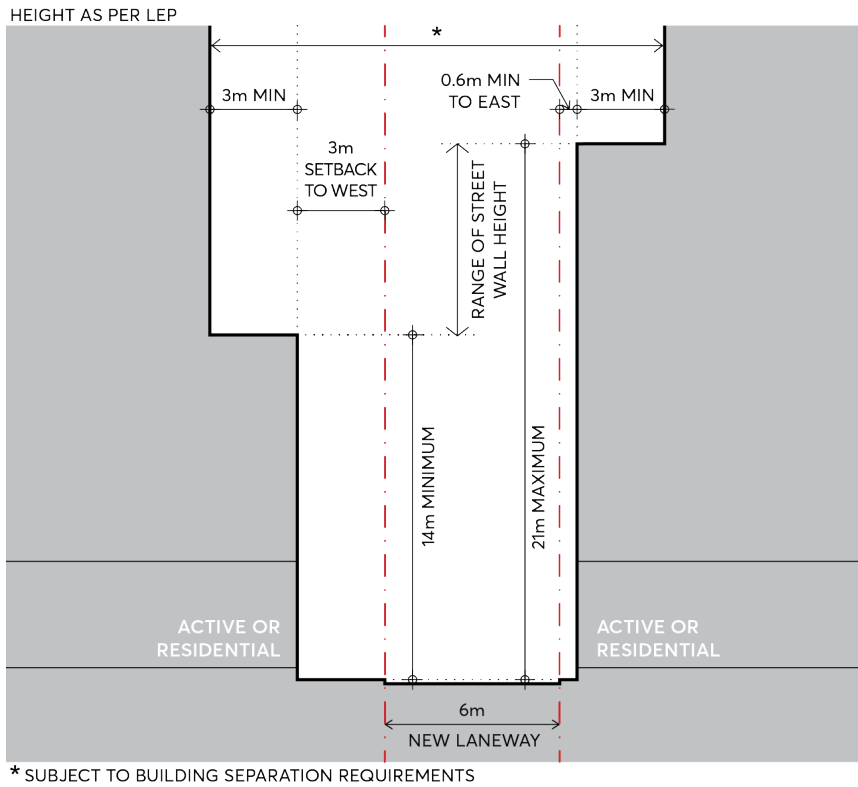

Figure 9.5.7.9 – New North-South Laneway (Section E) Setbacks and Street Wall Height

- h) Setbacks and street wall heights to Jubilee Park must comply with Figure 9.5.7.10 (Section F). The lower building massing must be set back 3 metres from the Jubilee Park boundary to provide a publicly accessible through site link, and the tower must be set back a minimum of 15 metres from the Jubilee Park boundary.

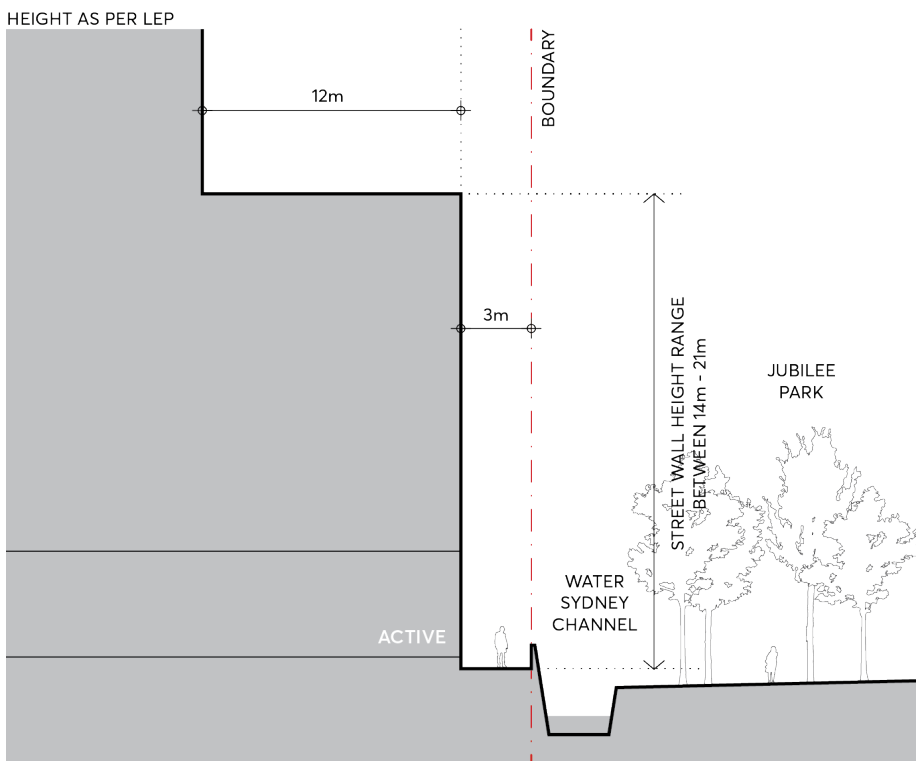

Figure 9.5.7.10 – Jubilee Park Edge (Section F) Setbacks and Street Wall Height

- i) Setbacks and street wall heights to any new parks or plaza spaces must comply with Figure 9.5.7.11 (Section G). The lower building massing must be built to the boundary a minimum of 14 metres and maximum of 21 metres above the park or plaza level, and the tower must be set back 3 metres from the boundary.

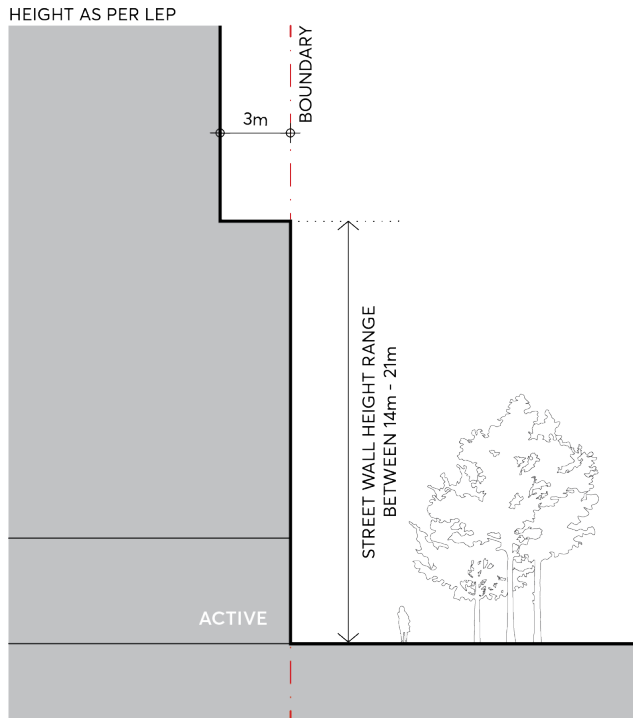

Figure 9.5.7.11 – New Civic Space or Park Edge (Section G) Setbacks and Street Wall Height

- C.05 Driveways servicing new development are not permitted on Church Street and High Street. Future driveways must be minimised and provided on future servicing streets or laneways.
- C.06 Tenancy widths on the ground floor in Church Street must allow for automotive or other large commercial uses.
- C.07 Where necessary, proposals must consider how safe pedestrian movement may be reasonably provided within the Auto Alley Special Area.

9.5.8 STATION STREET WEST

The Station Street West Special Area is located on the southern edge of the City Centre, characterised by its proximity to the railway line and high instance of built heritage, both in and around the precinct. The controls for this precinct ensure a more localised and heritage led response to the specific character established by these items, as well as setting a more defined edge to Station Street West as the precinct redevelops.

Future built form must consider the potential future development and public domain expected in the adjacent Marion Street Special Area to the north, and Auto Alley to the west. As a transition area, all development in the Station Street West Special Area must consider an expected massing of surrounding sites to ensure an appropriate response to future context. Development must also provide a measured response to the Tottenham Street Heritage Conservation Zone located to the south, ensuring future outcomes do not negatively impact the amenity of the Federation Period cottages in this location.

Objectives

- O.01 Encourage respectful built form that relates to the existing subdivision, material, and scale of the area. Conserve heritage cottages to the highest standard and encourage the adaptive reuse of heritage items to maintain their importance into the future.
- O.02 Ensure future built form does not adversely impact the solar amenity of the Tottenham Street Heritage Conservation Zone to the south.
- O.03 Increase precinct permeability with the delivery of new, publicly accessible through site links in desired locations.
- O.04 Create a consistent edge to Station Street West that adjusts the street boundary, providing a more contiguous street frontage which follows the alignment of the street.
- O.05 Minimise tower floorplates to encourage compliant separation distances and maximise amenity on narrow, east-west sites.
- O.06 Improve the pedestrian amenity and legibility of Station Street West through an expanded public domain and dedicated easement for future footpath widening.
- O.07 Create a scale transition corridor along High Street that enhances solar access and views to sky by ensuring tower components are set back as reinforced by 12 metres maximum building heights in the *Parramatta LEP 2023*.



Figure 9.5.8.1 – Station Street West Public Domain & Alignment

Controls

Unless modified or specifically excluded below, all controls in Sections 9.1 - 9.4 and Sections 9.6 - 9.9 apply to development within the Station Street West Special Area.

- C.01 Future development must create a consistent edge to Station Street West that follows the alignment of the rail corridor and comply with the street setback line as per Figure 9.5.8.1. This alignment must facilitate a potential footpath widening on Station Street West to accommodate increased pedestrian traffic from Harris Park Train Station.
- C.02 The delivery and location of new publicly accessible through site links in the Station Street Special Area must comply with Figure 9.5.8.1.
- C.03 Future development must comply with the following envelope controls:
 - a) Street setbacks and street wall heights on Station Street West must comply with Figure 9.5.8.2 (Section A). A 3-storey street wall must be built to follow the variable street setback as per Figure 9.5.8.1, and towers must be setback a minimum of 6 metres from the street wall.

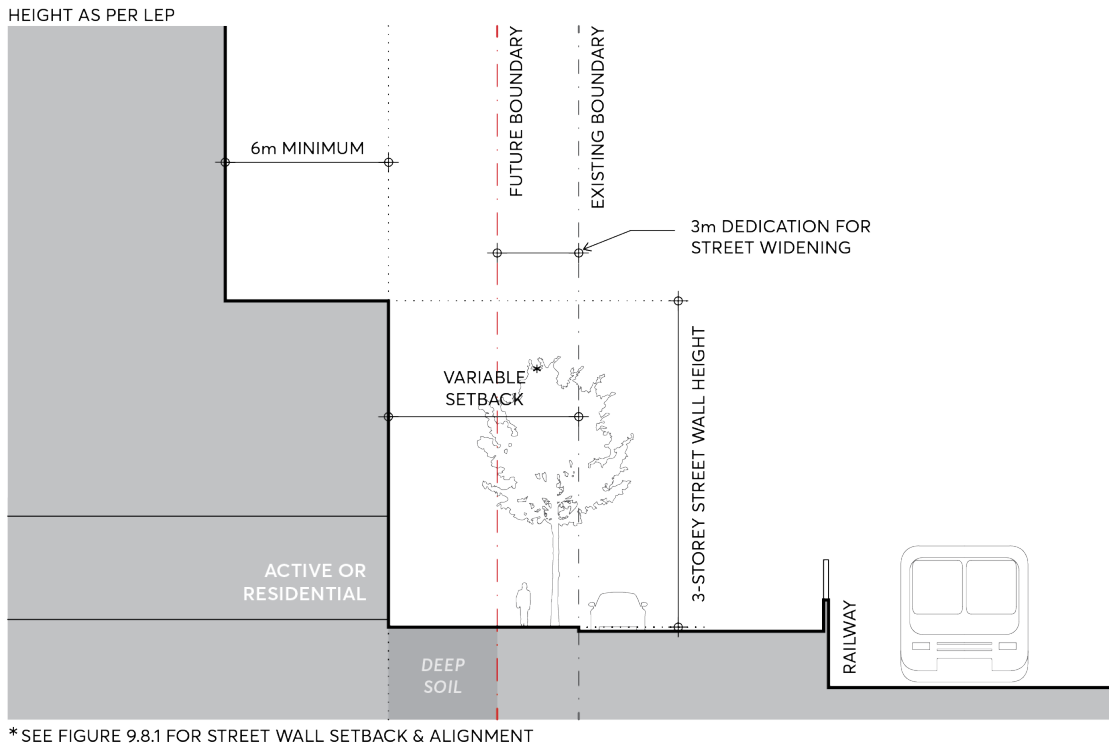

Figure 9.5.8.2 – Station Street West (Section A) Setbacks and Street Wall Height

- b) Street setbacks and street wall heights on High Street must comply with Figure 9.5.8.3 (Section B). A 12 metre high street wall must be set back 6 metres from the street boundary. Any upper levels must be set back 15 metres from the boundary in accordance with the Height of Buildings Map in the *Parramatta LEP 2023* in response to adjoining heritage fabric.

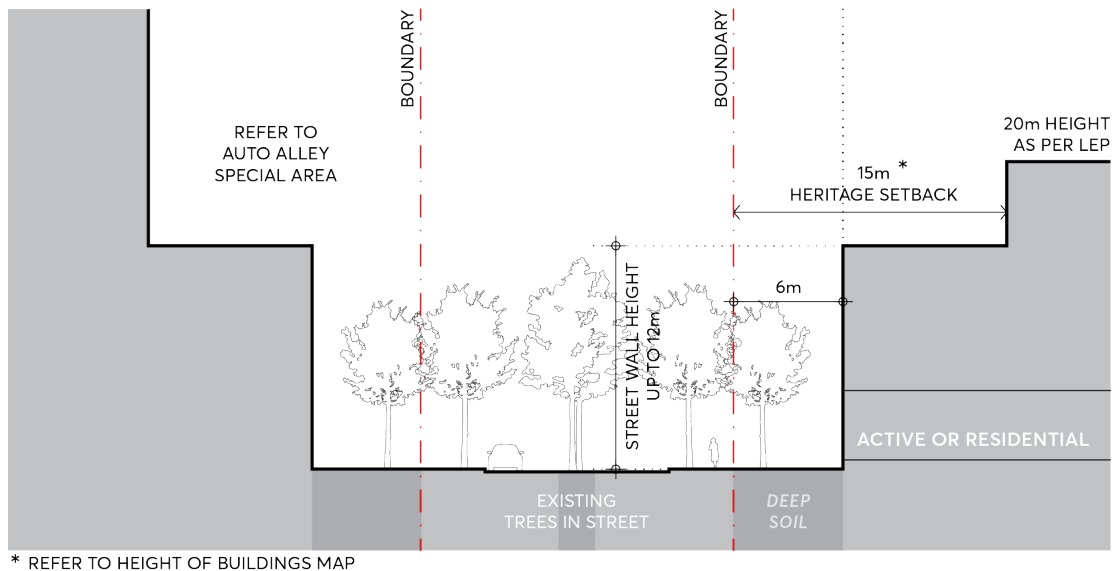

Figure 9.5.8.3 – High Street (Section B) Setbacks and Street Wall Height

- c) Street setbacks and street wall heights on Raymond Lane must comply with Figure 9.5.8.4 (Section C). The building is to be set back 6 metres from the laneway boundary to provide private landscape, and towers on the eastern side of Raymond Lane set back a minimum 3 metres from the street wall.

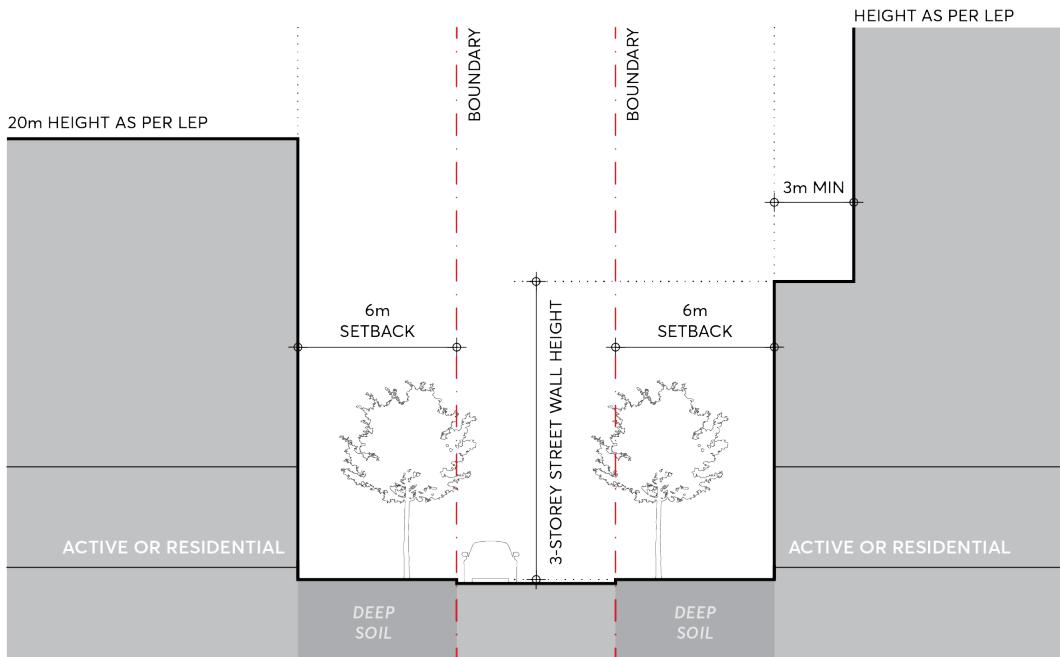
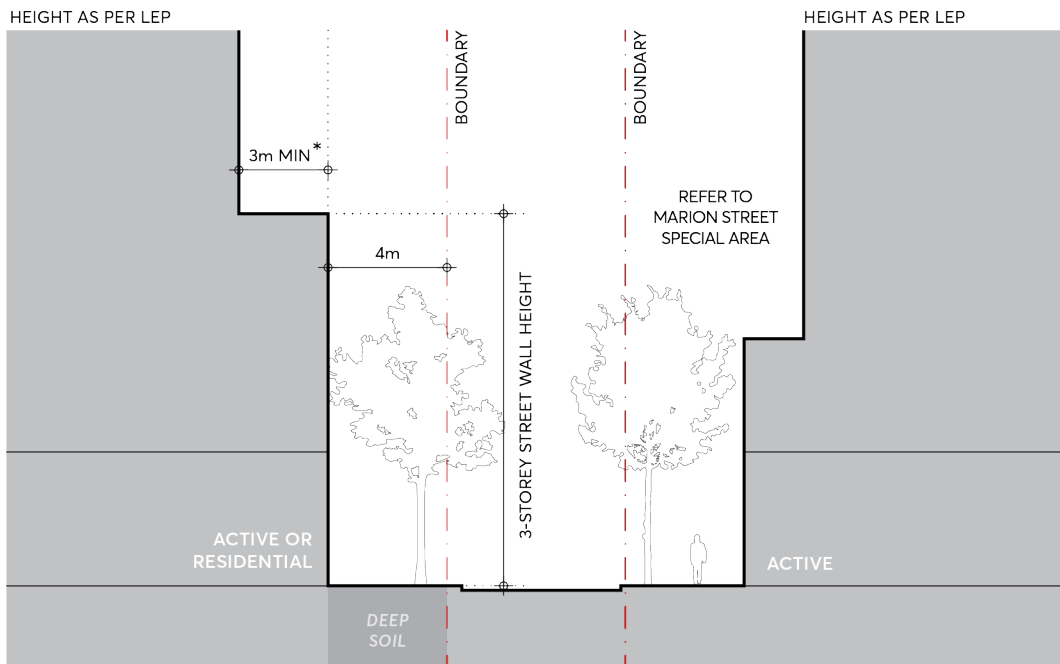

Figure 9.5.8.4 – Raymond Lane (Section C) Setbacks and Street Wall Height

- d) Street setbacks and street wall heights on Station Lane must comply with Figure 9.5.8.5 (Section D). The street wall must be set back 4 metres from the laneway boundary and towers set back a minimum 3 metres from the street wall.



* SUBJECT TO BUILDING SEPARATION REQUIREMENTS

Figure 9.5.8.5 – Station Lane (Section D) Setbacks and Street Wall Height

- e) Street setbacks and street wall heights on Raymond Street must comply with Section 9.3.3 – The Building Envelope.

9.5.9 CREEK CORRIDORS

The Parramatta River and its tributaries have been a place of cultural significance for first nations peoples for thousands of years. The land beside the stream now known as Clay Cliff Creek was a vital source of food and living resources, where fresh water met the ebb and flow of tidal water in the River. The land also played a critical role in the survival of Sydney, with well documented post-colonial occupation.

Development along the edges of Clay Cliff Creek and other creek corridors traversing the City must recognise their cultural and historical values as a shared public resource. While some significant development has already occurred through part of the City's creek corridors, the remaining open space must be enhanced to create a collective landscape corridor and flood mitigation element for the City.

By utilising a consistent deep soil setback to any development along the City's creek corridors, future development must create a highly visible, vegetated, and functional connection between existing green spaces, heritage destinations and transport nodes along creek corridors.

Objectives

- O.01 Establish Clay Cliff Creek and other tributaries of the Parramatta River as priority green corridors for ecological protection, flood sensitive strategies and future landscape improvements.
- O.02 Develop creek corridors as landscape and cultural assets, protecting landscape setbacks and biodiversity, and contributing to ecological resilience.
- O.03 Protect and enhance local and regional biodiversity, maximising the extent and integrity of aquatic and natural land areas along creek corridors in the City Centre.
- O.04 Employ Water Sensitive Urban Design strategies to limit pollutants entering Parramatta River and its associated waterways.
- O.05 Utilise a deep soil setback zone to create a contiguous landscape along creek corridors with the intention of leaving space for a publicly accessible movement corridor in the future.
- O.06 Identify opportunities for interpreting cultural and environmental values in the adjoining landscape, built form and lighting subject to Council's strategies.

Controls

Unless modified or specifically excluded below, all controls in Sections 9.1 - 9.4 and Sections 9.6 - 9.9 apply to development within the Creek Corridors Special Area.

- C.01 Creek frontage heights and building setbacks on any creek corridor must comply with Figure 9.5.9.1.
- C.02 Development must provide a minimum building setback of 6 metres to any creek corridor, as measured from the top of bank, delivered as deep soil. The extent of open to sky deep soil adjacent to any creek corridor must be designed to the satisfaction of Council's flood engineers. In some instances, the minimum 6 metre building setback from top of bank may be inadequate for meeting Council's flood mitigation requirements.

C.03 Development must provide a minimum 6 metre tower setback to support views to sky from a creek corridor and natural daylighting to deep soil and vegetation.

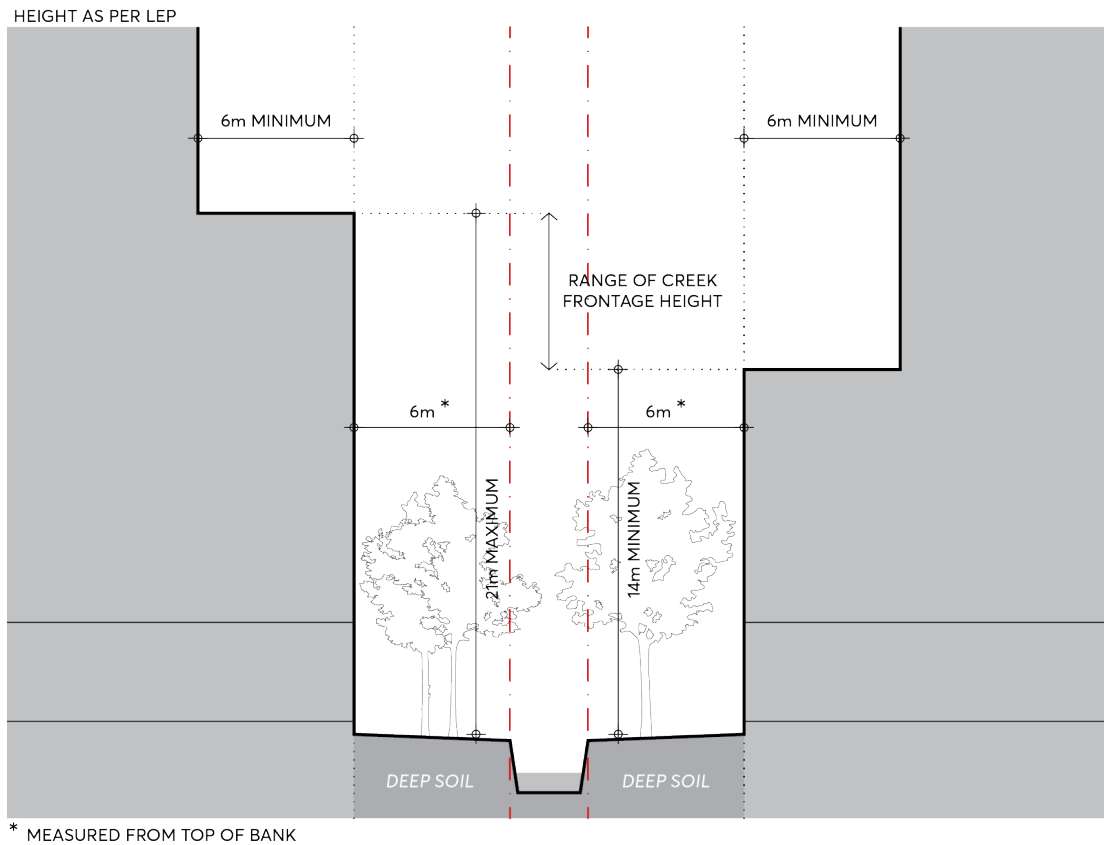

Figure 9.5.9.1 – Creek Corridor Setbacks and Street Wall Height

- C.04 Protect existing vegetation that supports the ecological function of creek corridors. Future landscaping facing any creek corridor must be flood resilient and demonstrate its compatibility with the relevant riverine, estuarine or forest ecosystem.
- C.05 Provide a sense of address to creek corridors, particularly where a future public connection may be provided, and follow design principles of The Street Wall contained within Section 9.3 – Built Form. Where above ground carparking is included, commercial or residential sleeving must be provided for passive surveillance to landscaped areas.
- C.06 Creek corridor setback zones must be free of ancillary elements, servicing, and other structures.

9.5.10 PARK EDGE HIGHLY SENSITIVE AREA

The Park Edge Highly Sensitive Area is located at the western edge of the Parramatta City Centre adjacent to and including part of Parramatta Park (see Figure 9.5.10.1). Buildings within this area form a backdrop to Parramatta's Old Government House and Domain (OGHD).

OGHD is one of eleven sites in a group forming the Australian Convict Sites on the UNESCO World Heritage List. OGHD is also on the National Heritage List. The Park Edge Highly Sensitive Area has been identified in the study *Development in Parramatta City and the Impact on Old Government House and Domain's World and National Heritage Listed Values Planisphere 2012*, as an area where development is likely to have a significant impact on the world and national heritage values of OGHD, unless it is designed to mitigate potential impact to below a significant impact threshold.

In this study, the key determinants of whether development will have a significant impact on the world and national heritage values of OGHD are the view sheds of the highly significant views from and of OGHD, the proximity of the development to OGHD and topography.

Under the Commonwealth *Environment Protection and Biodiversity Conservation (EPBC) Act 1999*, development that is likely to have a significant impact on the world and national heritage values of OGHD must be referred to the Australian Government Department of Sustainability, Environment, Water, Populations and Community for approval from the Australian Government Environment Minister.

As this requirement has led to uncertainty and additional assessment processes, Council has worked with the Commonwealth and State Governments to enter into a *Conservation Agreement*. This agreement is made under the *EPBC Act* and removes the need for Commonwealth referrals of developments within the Park Edge Highly Sensitive Area under the *EPBC Act*, so long as the proposed development complies with the specified planning controls in the agreement. Compliance with these specified planning controls will mitigate significant impacts of development on the values of OGHD under its world and national heritage listing.

The planning controls include the applicable maximum building height and floor space ratio controls in the *Parramatta City Centre LEP 2007* as Annexed to the Conservation Agreement (which are translated into *Parramatta LEP 2023*) as well as the controls outlined in this section (which include a graphical improvement of the supporting figures in the DCP control figures also Annexed to the Conservation Agreement). When development complies with these controls, applications will not need to be referred to the Commonwealth Government for approval under the *EPBC Act*.

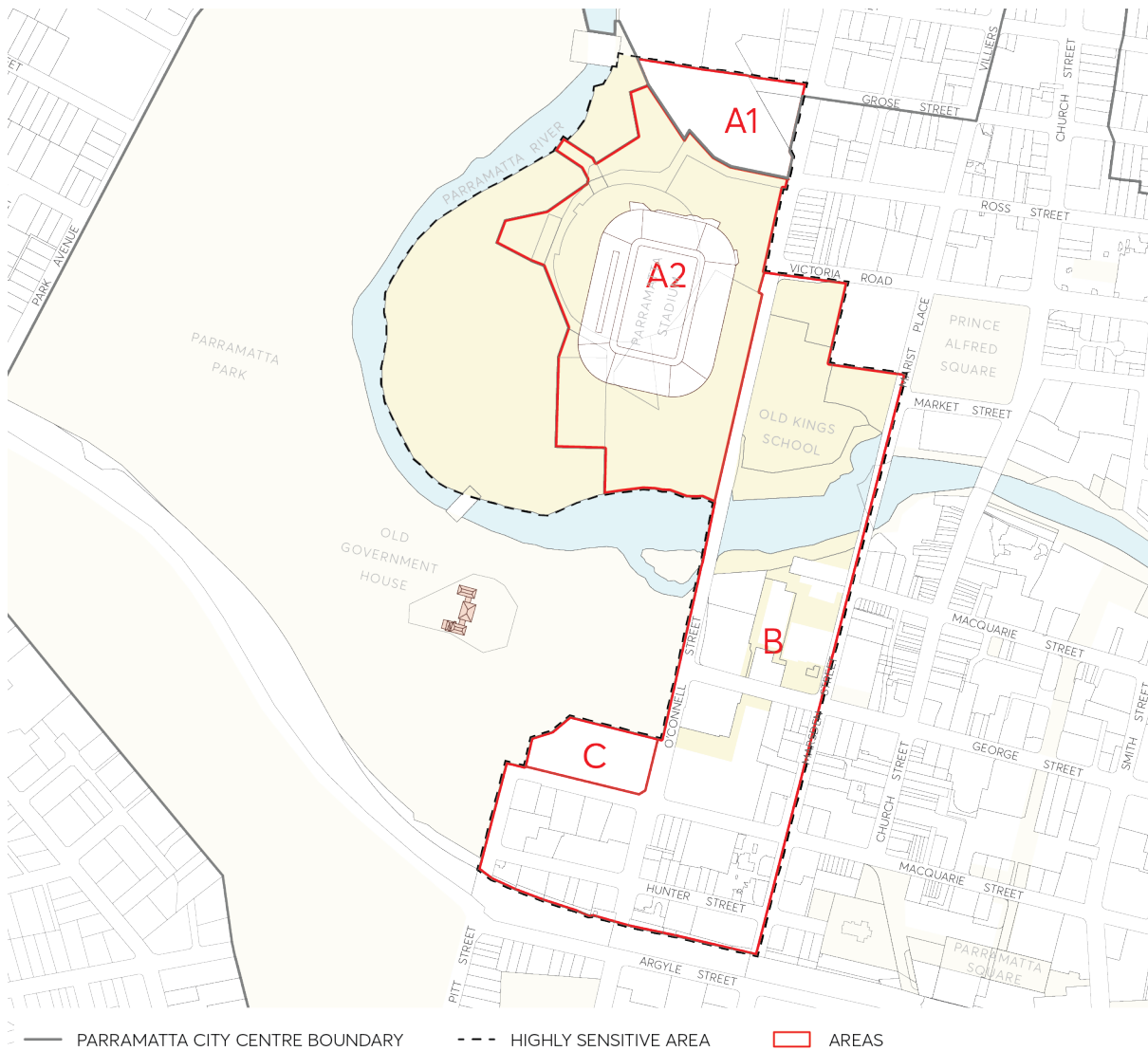

Figure 9.5.10.1 – Park Edge Highly Sensitive Area including sub areas

Controls

The Park Edge Highly Sensitive Area is divided into four sub areas as shown in Figure 9.5.10.1 above, with specific controls relating to each sub area as follows:

Area A1 - Parramatta Leagues Club Site

Development within Area A1 must comply with the following:

- C.01 At least 80% of the building height must be contained below the level of the surrounding established tree canopy of Parramatta Park when viewed from any of the key viewing locations from OGH shown in Figure 9.5.10.9. Any building element must be oriented to minimise the visual impact from these viewing locations.
- C.02 External building materials must be muted in colour with matt finishes to minimise contrast with the park surrounds and be complementary to its setting.

C.03 Signage on the upper level of buildings must not face the Domain of Parramatta Park.

Area A2 – Western Sydney Stadium and Car Park

C.04 At least 80% of the building height (other than lighting towers for Western Sydney Stadium) must be contained below the surrounding established tree canopy of Parramatta Park when viewed from any of the key viewing locations from OGH D shown in Figure 9.5.10.9. Buildings must be oriented to minimise the visual impact from these viewing locations.

C.05 External building materials must be muted in colour with matt finishes to minimise contrast with the park surrounds and be complementary to its setting.

C.06 Signage on the upper level of buildings must not face the Domain of Parramatta Park.

Area B -

C.07 The street frontage height for podiums, setbacks to the street, side and rear boundaries must comply with Figures 9.5.10.5, 9.5.10.6 and 9.5.10.7.

C.08 Upper level building setbacks must contribute to spaces between buildings and an openness in the city skyline, with upper level setbacks of:

- a) 8 metres at the river foreshore as shown in Figure 9.5.10.2; and
- b) 6 metres at the street frontage as shown in Figure 9.5.10.3; except for George Street (see C.09)

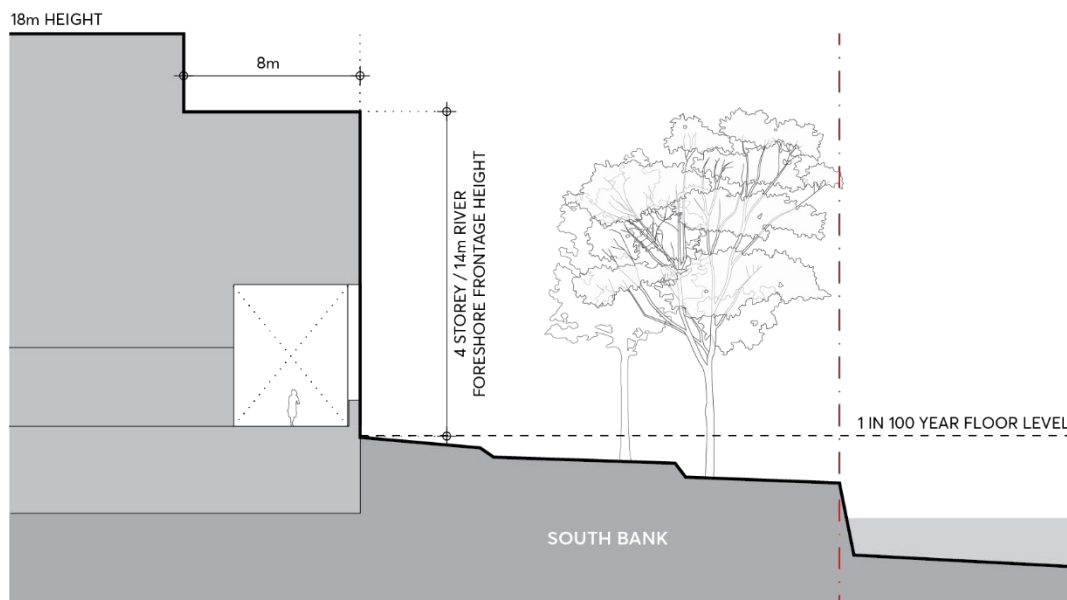

Figure 9.5.10.2 – River Foreshore Frontage Height and Building Setbacks

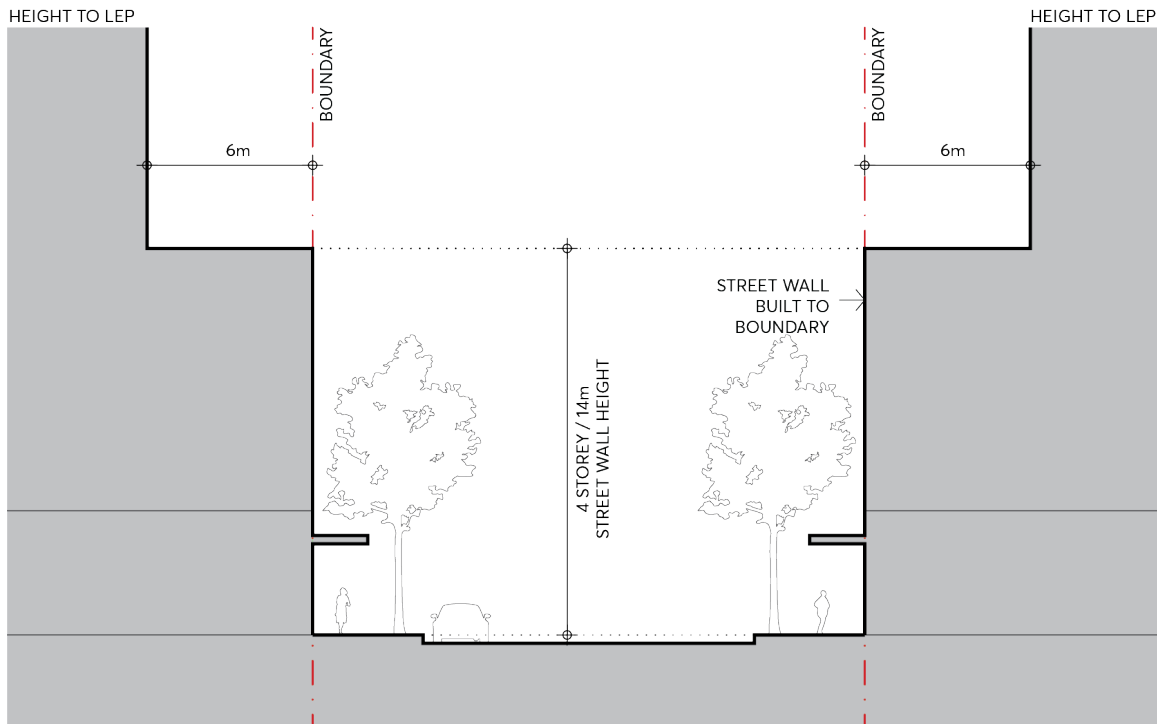

Figure 9.5.10.3 – Park Edge Highly Sensitive Area Street Wall Height and Setbacks

C.09 Upper level building setback to George Street of 20 metres must comply with Figure 9.5.10.4, to frame the vista along this street, reinforcing the historic Georgian town plan and the relationship between George Street and OGHD.

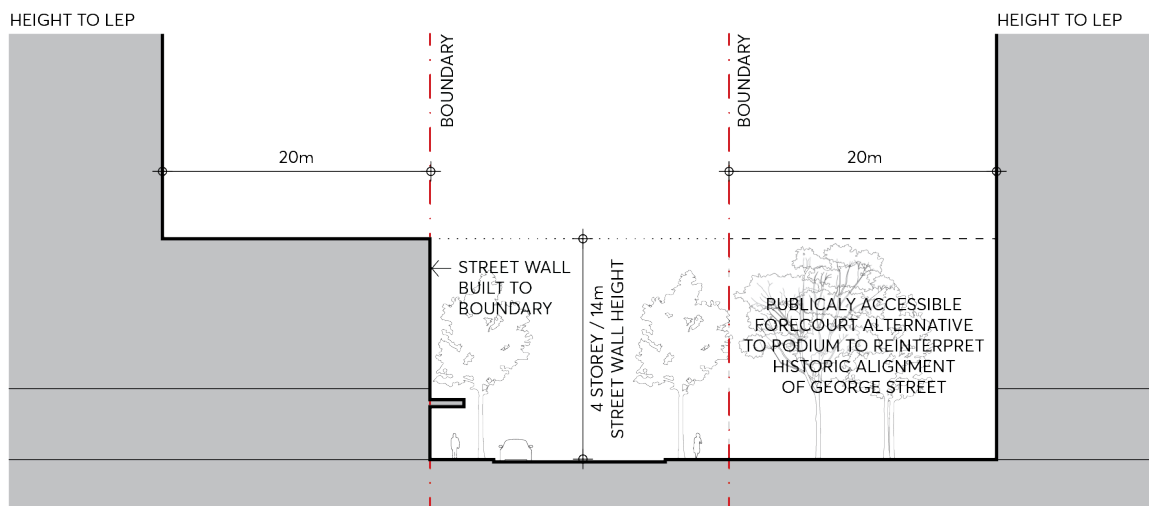

Figure 9.5.10.4 – George Street west of Marsden Street – Street Wall Height and Building Setbacks

C.10 Upper level side and rear building setbacks must comply with Figure 9.5.10.5 to contribute to spaces between buildings and an openness in the city skyline.

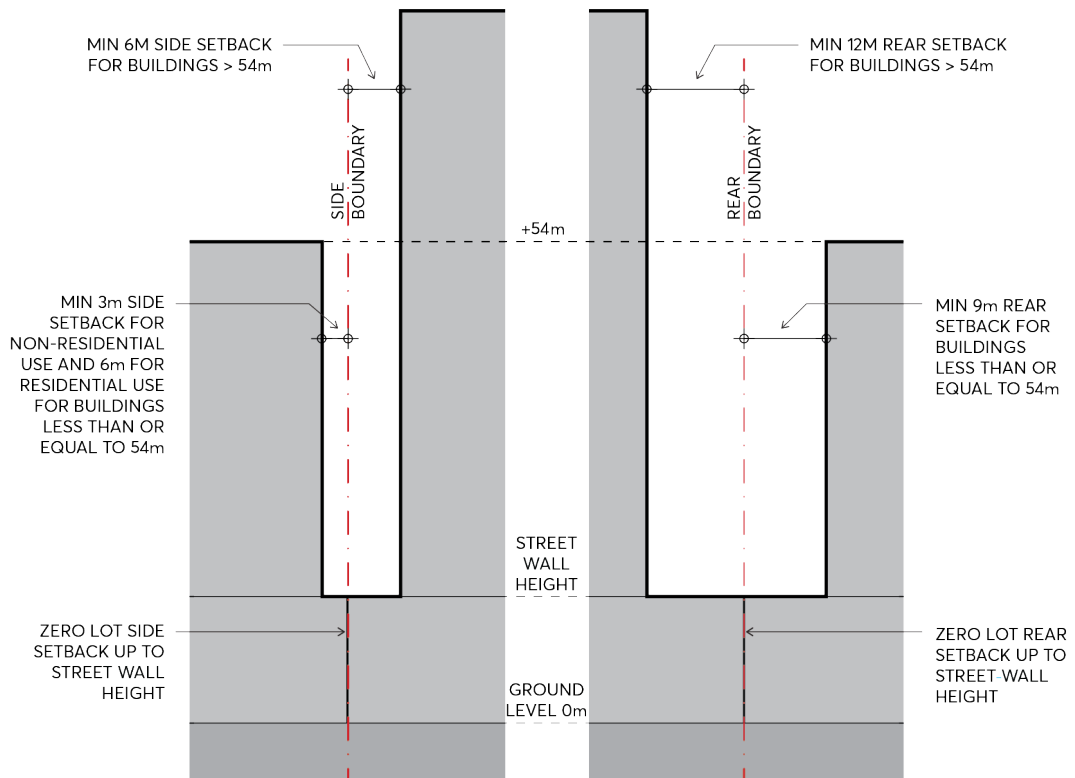

Figure 9.5.10.5 – Park Edge Highly Sensitive Area Side and Rear Setbacks

- C.11 Where reasonably practicable, having regard to the orientation of the development parcel, buildings must be oriented with their narrow end not exceeding 30 metres in width facing the Domain.
- C.12 External building materials must reduce visibility against the sky, for example, use of light colours or reflective surfaces.
- C.13 Signage on the upper level of buildings must not face the Domain of Parramatta Park.

Note – Minor departures exceeding the above built form controls (by up to 5%) for Area B will only be permitted where the consent authority is satisfied that the visual impact of the proposed development will not visually dominate OGH D as a result of any such variation when the proposed development is viewed from any of the key viewing locations from OGH D shown in Figure 9.5.10.9.

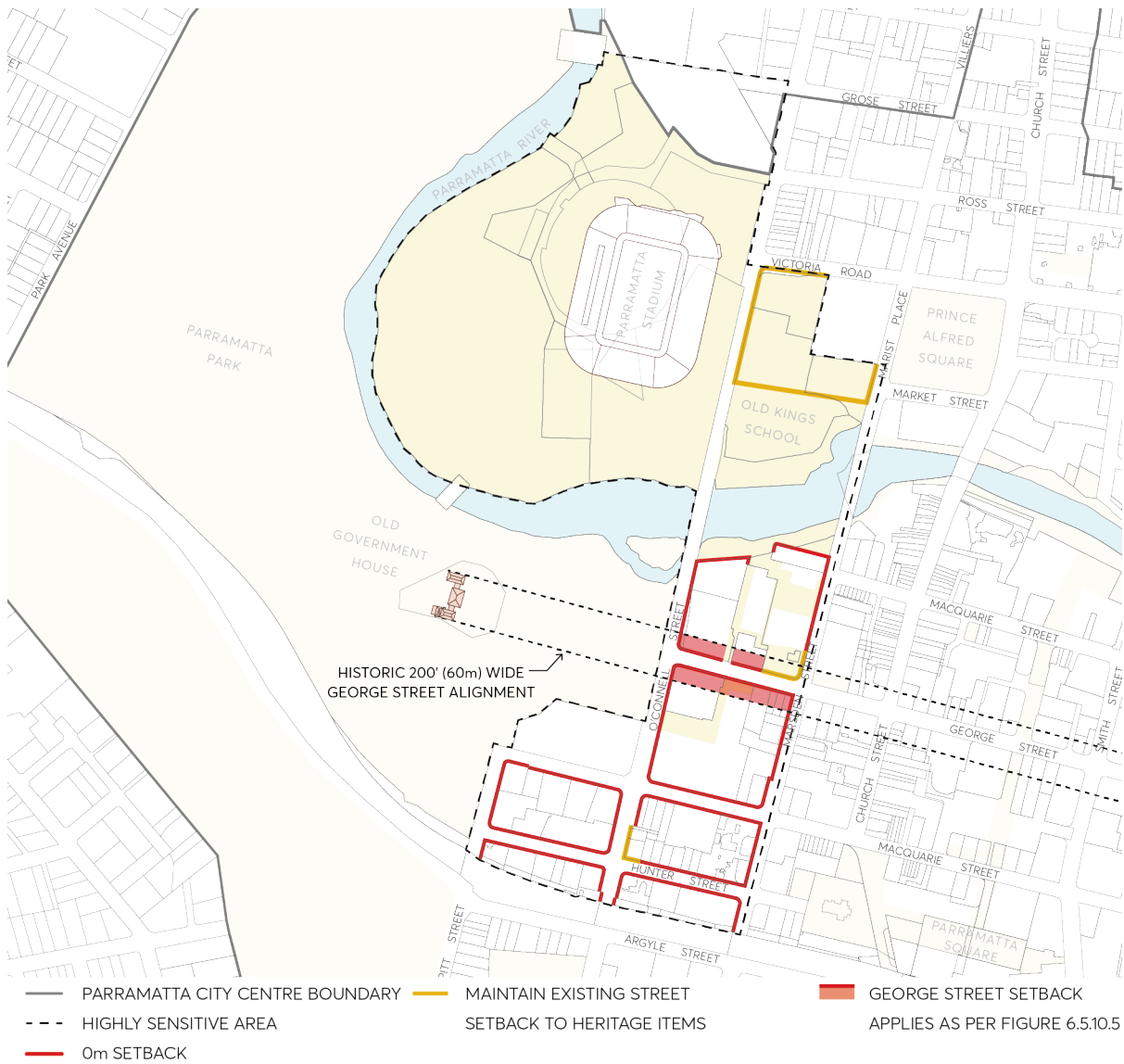

Figure 9.5.10.6 – Building Alignment and Front Setbacks (to streets, public domain and water courses)

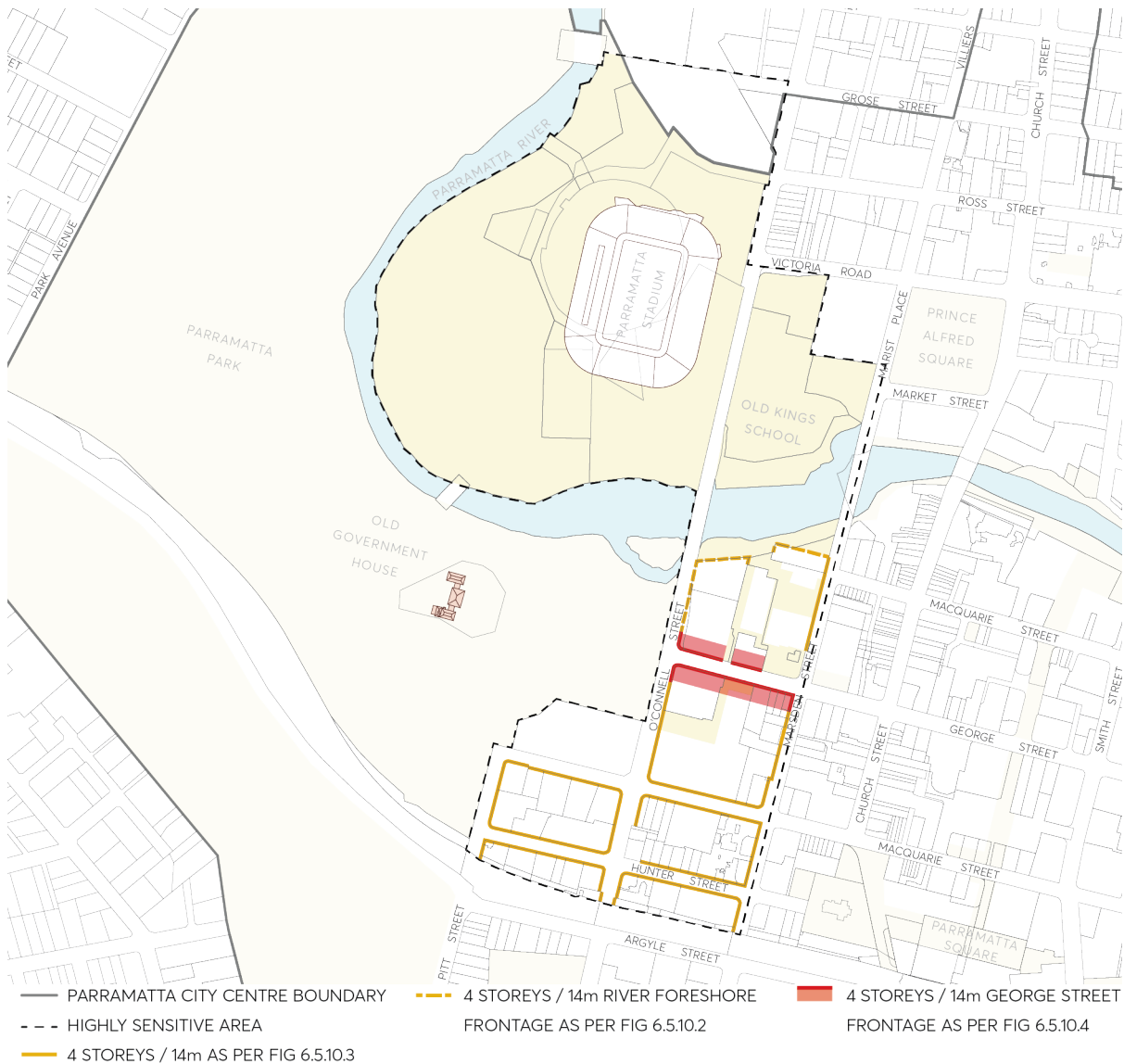

Figure 9.5.10.7 – Street Wall / River Frontage Heights (Podiums)

Area B - Building Height and Floor Space Ratio controls

The *Parramatta LEP 2023* specifies the applicable maximum building height and floor space ratio controls for Area B within the Park Edge Highly Sensitive Area. Bonus height and floor space ratio provisions under the LEP apply when the development exhibits design excellence as judged under an architectural design competition.

When a design competition is carried out for development within the Park Edge Highly Sensitive Area, the brief for the design competition will specify that consideration must be given to the protection of the world and national heritage values of OGH from significant impacts when the proposed development is viewed from any of the key viewing locations shown in Figure 9.5.10.9 and that development complies with the specific requirements of this section of the DCP.

In Area B, minor variations to building height such as for architectural roof features, or minor variations in floor space ratio of up to 5%, will only be permitted where the consent authority is satisfied that the visual impact of the proposed development will not visually dominate OGH as a result of any such

variation when the proposed development is viewed from any of the key viewing locations from OGHD shown in Figure 9.5.10.9.

Area C – Lot 362 DP 752058, No. 2 Macquarie Street Parramatta (RSL Site)

- C.14 Built form is to provide minimum setbacks to Parramatta Park as indicated in Figure 9.5.10.8. The setbacks are to provide a transition from built form to the soft landscaping in Parramatta Park and are to be predominantly landscaped.

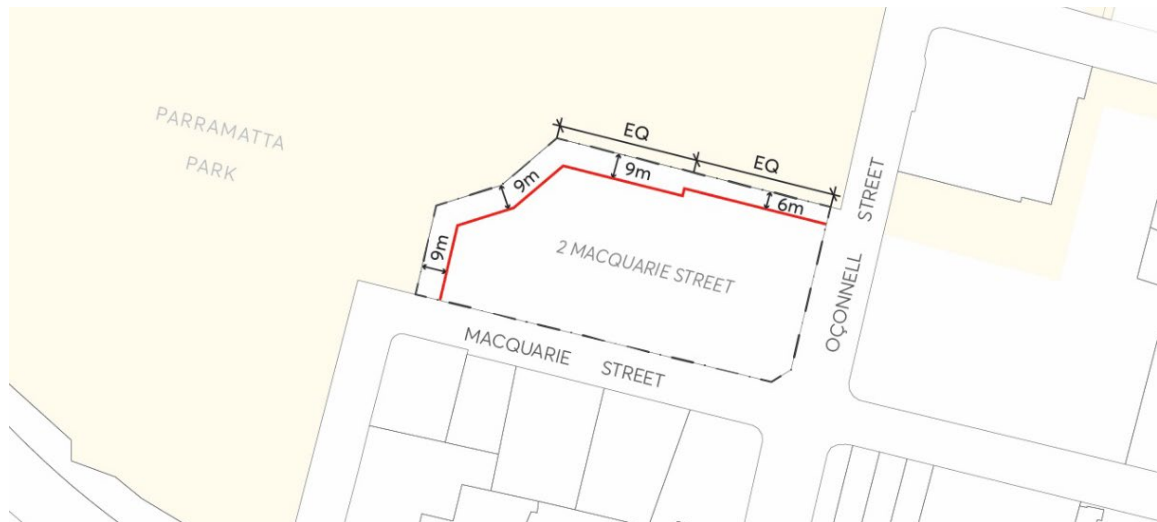

Figure 9.5.10.8 – Setbacks to Parramatta Park at 2 Macquarie Street Parramatta

- C.15 Buildings are to be sited to enable the retention and protection of the heritage fence at the O'Connell Street and Macquarie Street frontages. The siting and spacing of buildings across the site shall also respect the important relationship of the RSL site to the landscape setting of Parramatta Park, including the park entrance from Macquarie Street and the George Street Gatehouse at this entrance.
- C.16 The maximum building height is 10 metres.
- C.17 External building materials must be muted in colour with matt finishes to minimise contrast with the park surrounds and be complimentary to its setting.
- C.18 Signage on the upper level of buildings must not face the Domain of Parramatta Park.

Protection of important views to and from Old Government House and Domain

Within the Park Edge Highly Sensitive Area, development must not be carried out that obstructs the sight lines between Old Government House and the Old Kings School site and the spire of St Patrick's Cathedral.

Note – Parramatta Park is also listed on the NSW State Heritage Register and as an item of State Heritage significance in Schedule 5 of *Parramatta LEP 2023*. These listings mean that the provisions of the *Heritage Act 1977* and the heritage clauses of *Parramatta LEP 2023* must be complied with for development on or within the vicinity of OGHD. These considerations do not impact on the referral requirements of the *EPBC Act*.

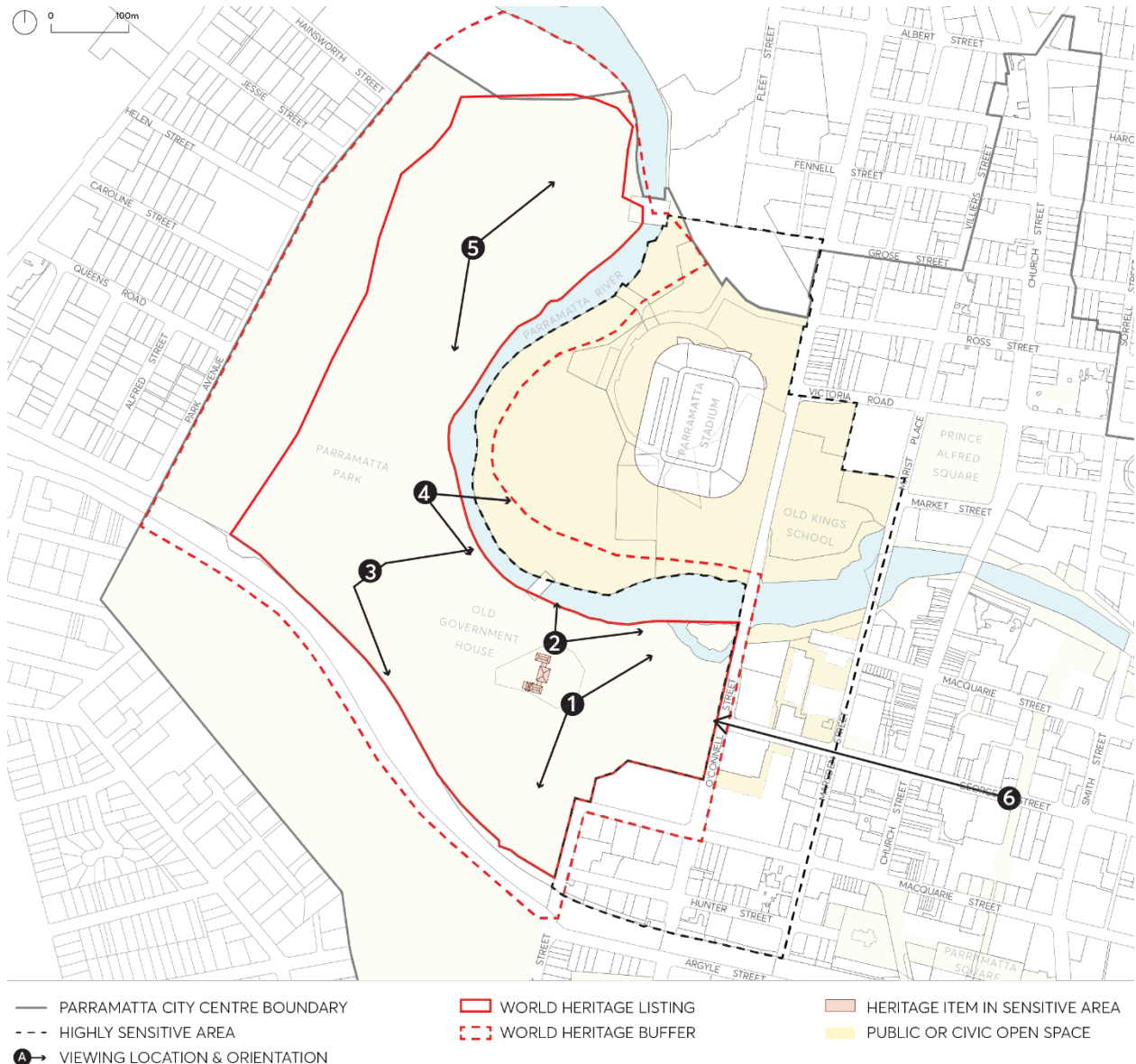

View	Description
1	From lawns east and south of Old Government House towards the City
2	From the north-east corner of Old Government House to Old Kings School
3	From Bath House area west of Old Government House to the City
4	Parramatta River views towards city from road within Parramatta Park on the west side of river.
5	From Diary Precinct within Parramatta Park looking north-east and south-east towards the City
6	West along George Street towards the George Street Gatehouse of Old Government House

Figure 9.5.10.9 – OGH Viewing Locations

9.5.11 CHURH STREET NORTH

The Church Street North Special Area as delineated in Figure 9.5.11.1 forms part of the northern extension of the Parramatta City Centre and is located between Victoria Road, Belmore Park and two highly sensitive heritage areas - the North Parramatta Heritage Conservation Area (HCA) to the west and the Sorrell Street HCA to the east. The Parramatta Light Rail runs along Church Street and serves the area with a stop between Harold and Fennell Streets. The future character of the area continues the high street functionality of Church Street to the south of the Parramatta River with street defining buildings and active uses at lower levels (see Section 9.5.4 Church Street).

As the area is largely confined to urban blocks along the axis of Church Street, there is a need to provide a transition in use and form to the surrounding low scale, largely residential setting of North Parramatta. On the eastern side of the Special Area, transition to the Sorrell Street HCA is achieved across blocks as building forms step up from a lower scale along Sorrell Street to towers along Church Street. East west view corridors between towers, mid-block tree planting, and street setbacks aligned to heritage buildings contribute to the transition. On the western side of the Special Area, Villiers Street separates future development from the North Parramatta HCA. Additional transition is achieved with a step in building height from Villiers Street to Church Street and with a generous street setback along Villiers Street with canopy tree planting forming a direct visual interface to the heritage area.

A number of buildings of heritage significance are located along Church Street and are contributing to the streetscape and human scale of the area. These buildings are of 1-2 storeys and have varied settings that require a bespoke design response. Some items contribute to an aligned street wall edge, while others are set back from the street and sit in space.

To unify development across the Special Area and respond to the broader heritage setting, consistent building setbacks along east-west streets are defined by prevailing heritage building frontage alignments. This not only allows heritage items to form a dominant part of the streetscape, but also provide opportunities to extend the vegetated character of North Parramatta by creating additional space for street tree planting within front gardens.

A new civic square, co-located with the light rail stop, provides much needed open space and opportunities for supporting multi-purpose community facilities that can be used for a range of programs and activities to serve the local community as identified in Council's Parramatta Community Infrastructure Strategy. New pedestrian through site links provide improved permeability and fine grain activity that complements Church Street. Communal open spaces within private development complement the public domain with landscaped courtyards and generous tree canopy in deep soil.

Church Street North Special Area controls aim to realise a mixed-use area of the City Centre with retail and commercial spaces at lower levels and predominantly residential uses within street edge podium and tower forms, arranged along green streets and around landscaped courtyards with increased tree canopy.



Figure 9.5.11.1 – Church Street North Special Area Framework

Objectives

- O.01 Conserve heritage buildings to the highest standard and activate street frontages through both the adaptive reuse of heritage items as well as the provision of active ground floor spaces within and around the heritage buildings in the Church Street North Special Area.
- O.02 Integrate heritage buildings as part of an overall site development strategy that achieves pedestrian connectivity and site permeability around the heritage buildings, resulting in a fine network of intimate streets and through site links in the area.
- O.03 Allow heritage items, including those in the adjacent HCAs, to be the dominant features of the streetscape and create defined view corridors along east-west streets from HCAs up to Church Street and visa versa.
- O.04 Maintain the vegetated character of North Parramatta by enabling large canopy trees in deep soil within the front setbacks, public domain and communal open spaces at ground.
- O.05 Extend the fine-grain high-street character of Church Street from south of the River, northwards towards Belmore Park to create continuity between the north and south of the City Centre.
- O.06 Provide building forms and communal open spaces that are appropriately proportioned for residential uses.
- O.07 Encourage slender tower forms and generous separation between towers to create views to sky between towers when observed from both the North Parramatta HCA and Sorrell Street HCA's.
- O.08 Orientate building forms to minimise their impact on HCAs and create consistent spacing between towers that aligns tower development across the block increasing views to sky.
- O.09 Locate towers to protect view corridors of historical and cultural value such as the views along the Church Street axis, views to Prince Alfred Park, and views along east-west streets.
- O.10 Protect solar access to significant public open spaces, the public domain, and adjacent.
- O.11 Ensure new publicly accessible spaces, such as through site links and civic squares, are suitable distributed, adequately sized, integrated with the broader public domain network, and designed to Council's standards.
- O.12 Improve legibility, pedestrian connections and enable transition between lots on Church Street, neighbouring lots, and HCAs through a permeable ground plane with visual and/or physical connectivity through the blocks in accordance with Figure 9.5.11.1 – Church Street North Special Area Framework.

Controls

Unless modified or specifically excluded below, all controls in Sections 9.1 to 9.4 and Sections 9.6 to 9.9 of this Part apply to development within the Church Street North Special Area.

- C.01 Site consolidation must comply with Figure 9.5.11.2 – Church Street North Special Area Public Domain and Consolidation Plan to realise the objectives of the Church Street North Special Area.
- C.02 New through site links and civic square identified in Figure 9.5.11.1 – Church Street North Special Area Framework and Figure 9.5.11.2 – Church Street North Special Area Public Domain and

Consolidation Plan must be delivered through development or dedicated to Council for delivery in a coordinated manner.



Figure 9.5.11.2 – Church Street North Special Area Public Domain & Consolidation Plan

C.03 Development within the Church Street Special Area must comply with the building setbacks specified in Figure 9.5.11.3 – Church Street North Special Area Building Setbacks.



Figure 9.5.11.3 – Church Street North Special Area Building Setbacks

C.04 Development within the Special Area must comply with the setback and envelope controls specified in Figure 9.5.11.4 – Church Street North Special Area Required Setbacks and Built Form.



Figure 9.5.11.4 – Church Street North Special Area Required Setbacks & Built Form

C.05 Development within the Special Area must comply with the following specified envelope controls:

- a) On Church Street, the street wall must be built to boundary as per Figure 9.5.11.5 unless otherwise specified in Figure 9.5.11.3 and Figure 9.5.11.4 to provide new civic square or curtilage to heritage items.

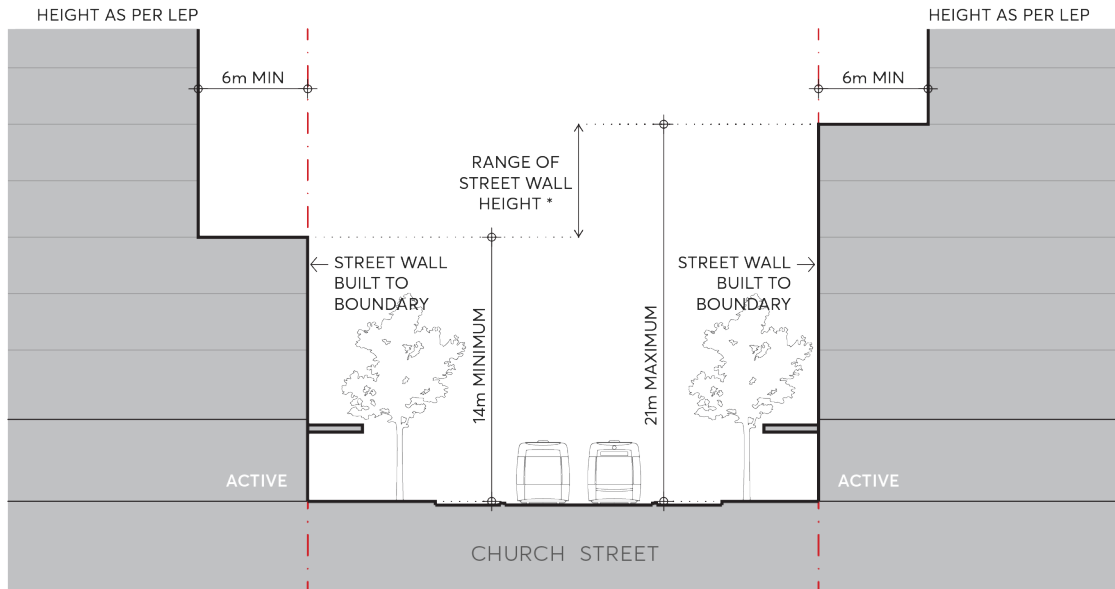

Figure 9.5.11.5 – Typical Setbacks and Street Wall Height on Church Street (Section A)

- b) On the eastern side of Villiers Street, a minimum 6m street setback must be provided of which 2m is to be dedicated to street widening for the Marsden Street Cycleway project as per Figure 9.5.11.6.

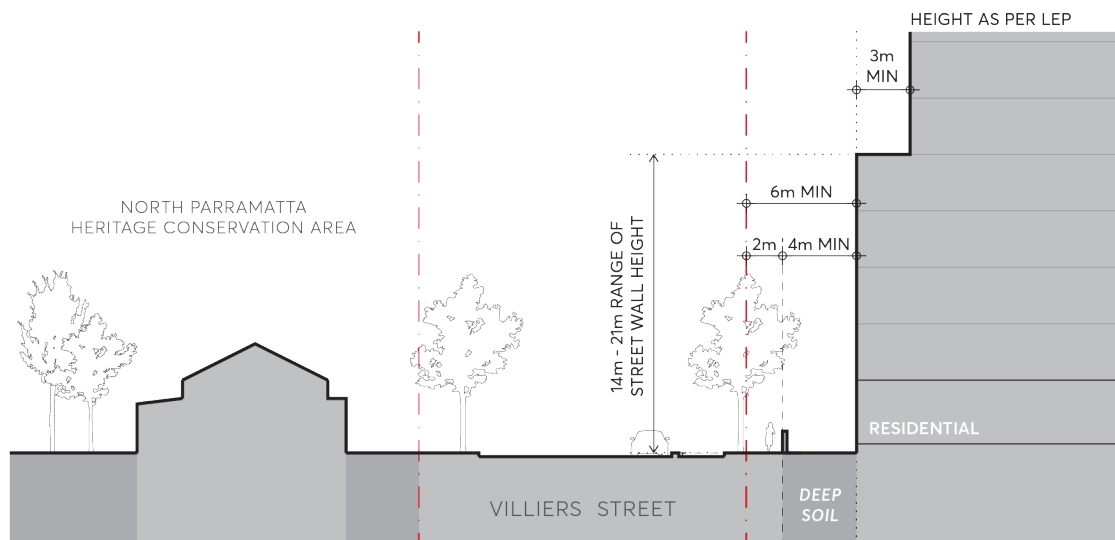

Figure 9.5.11.6 – Typical Setback and Street Wall Height on Villiers Street (Section B)

- c) Street setbacks and street wall heights on Harold Street must comply with Figure 9.5.11.7 (Section C). Development on the northern side of Harold Street must provide a 12 metre building setback to provide curtilage to the heritage item at 476 Church Street. The street

wall must be set back a minimum 3 metres from the street boundary on the southern side of Harold Street with the tower set back a minimum of 3 metres from the street wall.

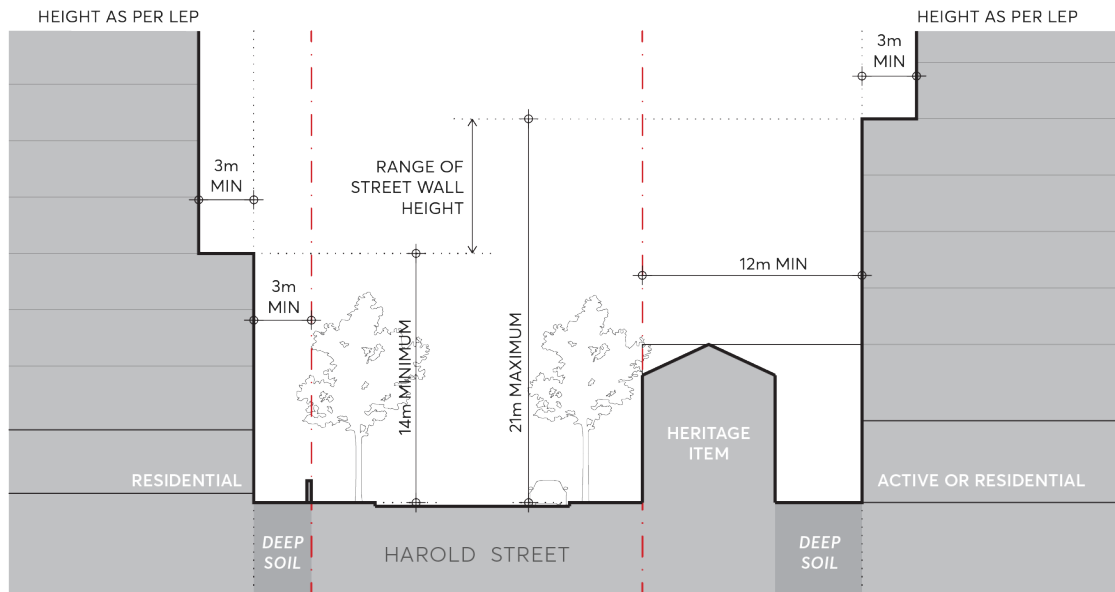
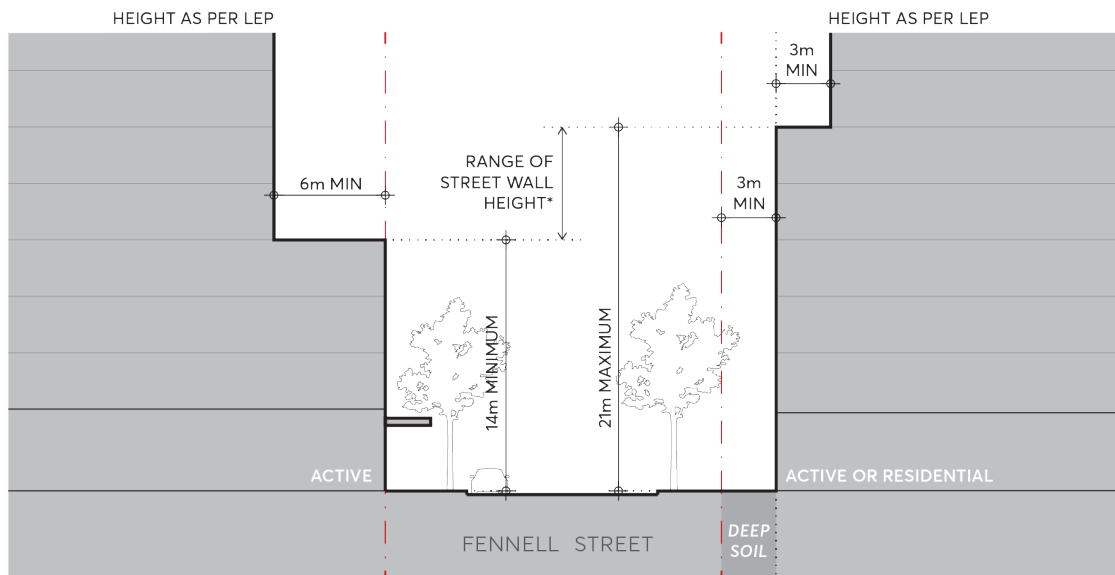

Figure 9.5.11.7 – Typical Setbacks and Street Wall Height on Harold Street (Section C)

- d) Street setbacks and street wall heights on Fennell Street must comply with Figure 9.5.11.8 (Section D). Development on the northern side of Fennell Street must provide a 3 metre building setback to align with the prevailing setback defined by heritage items on the street, and towers set back a minimum of 3 metres from the street wall. Development on the southern side of Fennell Street may be built to the street boundary with towers set back a minimum of 6 metres from the street wall.



* EXCEPT WHERE MAXIMUM STREET WALL HEIGHT HAS BEEN DEFINED BY THE LEP

Figure 9.5.11.8 – Typical Setbacks and Street Wall Height on Fennell Street (Section D)

- e) Street setbacks and street wall heights on Grose Street must comply with Figure 9.5.11.9 (Section E). Development on the northern side of Grose Street must provide a 3 metre building setback to align with the prevailing setback defined by heritage items on the street, and towers set back a minimum of 3 metres from the street wall. Development on the

southern side of Grose Street must provide a 2 metre building setback with towers set back a minimum of 6 metres from the street wall.

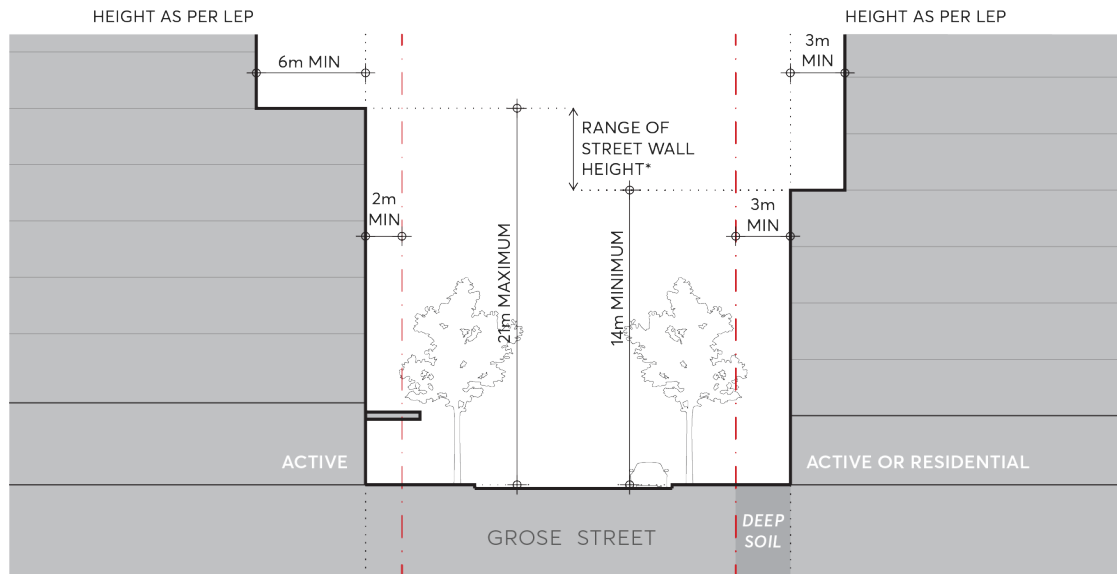

* EXCEPT WHERE MAXIMUM STREET WALL HEIGHT HAS BEEN DEFINED BY THE LEP

Figure 9.5.11.9 – Typical Setbacks and Street Wall Height on Grose Street (Section E)

- f) Street setbacks and street wall heights on Ross Street to the west of Church Street must comply with Figure 9.5.11.10 (Section F). Development on the northern side of Ross Street must provide a 10 metre building setback to provide curtilage around the heritage item at 387 Church Street. This space is to be provided as deep soil landscape to support large canopy tree planting. Development on the southern side of Ross Street may be built to the street boundary with towers set back a minimum of 6 metres from the street wall.

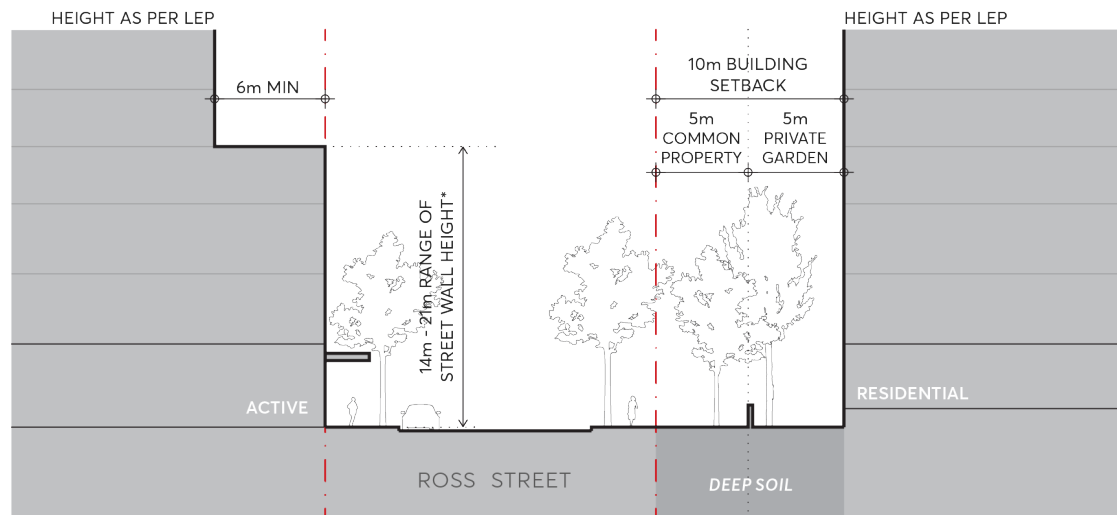

* EXCEPT WHERE MAXIMUM STREET WALL HEIGHT HAS BEEN DEFINED BY THE LEP

Figure 9.5.11.10 – Typical Setbacks and Street Wall Height on Ross Street (Section F)

- g) Buildings must provide a vegetated set back that is a minimum of 6 metres from the common boundary shared with lots to the east of the Church Street North Special Area, and towers set back a minimum of 9 metres from the common boundary as per Figure 9.5.11.11 (Section G), subject to building separation controls specified in C.07.

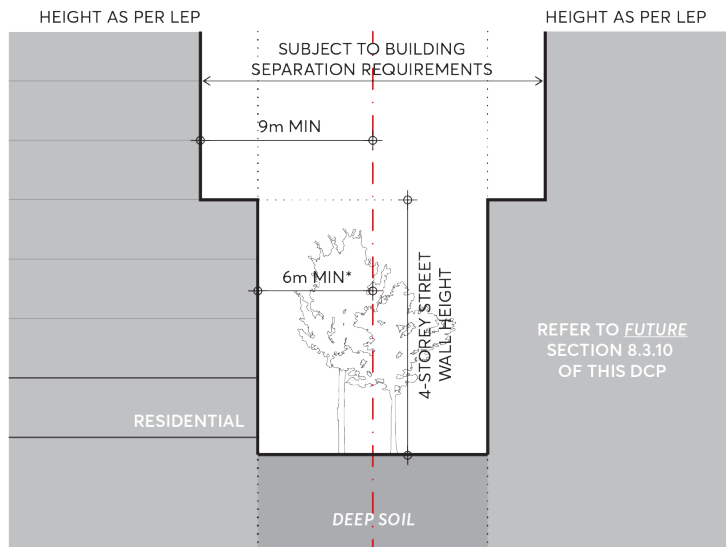

* UNLESS OTHERWISE SPECIFIED BY FIGURE 9.5.11.4

Figure 9.5.11.11 – Setbacks and Street Wall Height to boundary shared with mid-block properties to the east (Section G)

- h) Setbacks and street wall heights on east-west through site links must comply with Figure 9.5.11.12 (Section H). Development must provide a through site link that is a minimum of 6 metres wide. Tower setbacks are to be determined by building separation requirements.

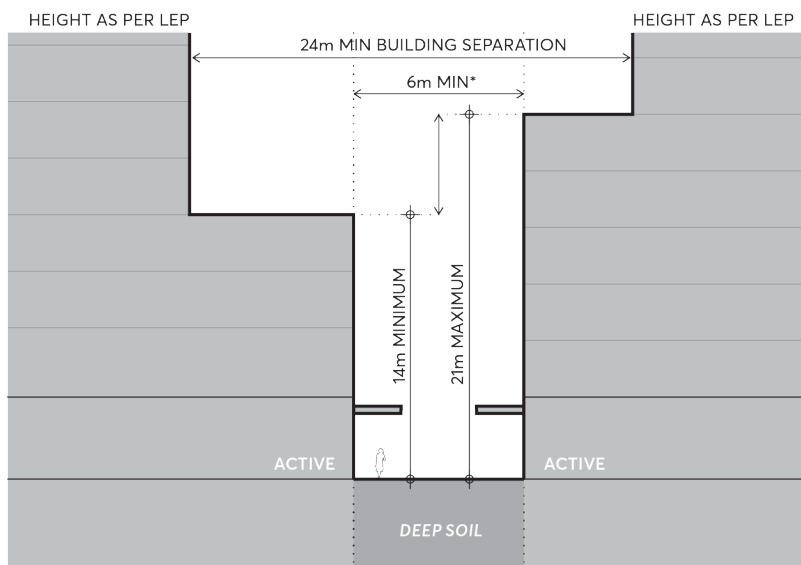

* WIDER THROUGH SITE LINK MAY BE REQUIRED SUBJECT TO BUILDING SEPARATION REQUIREMENTS

Figure 9.5.11.12 – East West (Section H) Through Site Link Setbacks and Street Wall Height

- i) Setbacks and street wall heights for any part of development at 440-444 to 458 Church Street must comply with Figure 9.5.11.13 (Section I). Development on these sites must provide a building set back of 14 metres from the street boundary to create curtilage around the heritage items. This set back must be open to sky and no part of the building may overhang heritage. Development on the western side of Church Street must be built to the street boundary with towers set back a minimum of 6 metres from the street wall.

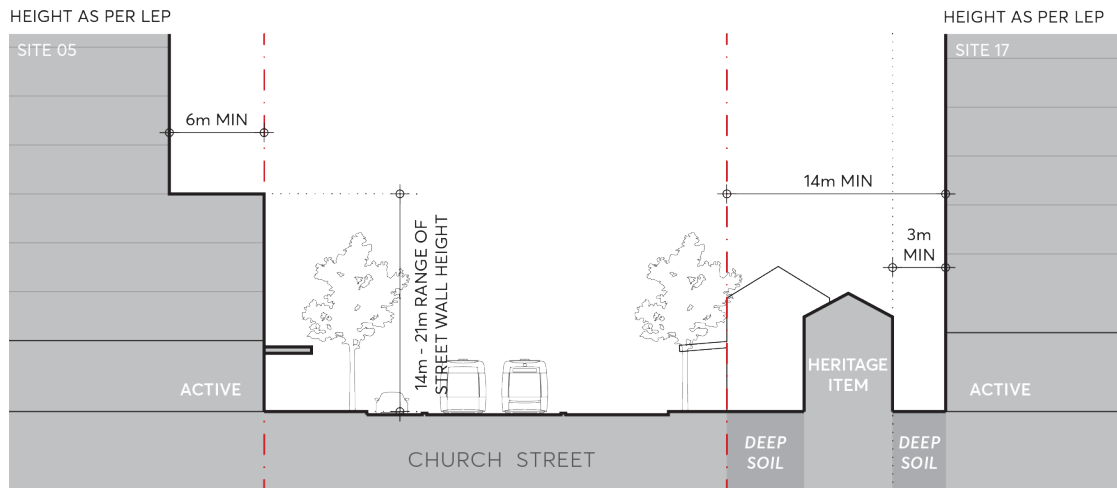

Figure 9.5.11.13 – Site 17 (Section I) Setbacks and Street Wall Height

- j) Setbacks and street wall heights on the future civic space must comply with Figure 9.5.11.14 (Section J). The civic space must have a minimum dimension of 30 metres in a north-south direction, and 24 metres in an east-west direction. The street wall height may be provided within the range of 14 metres to 21 metres, and towers set back a minimum of 3 metres from the street wall.

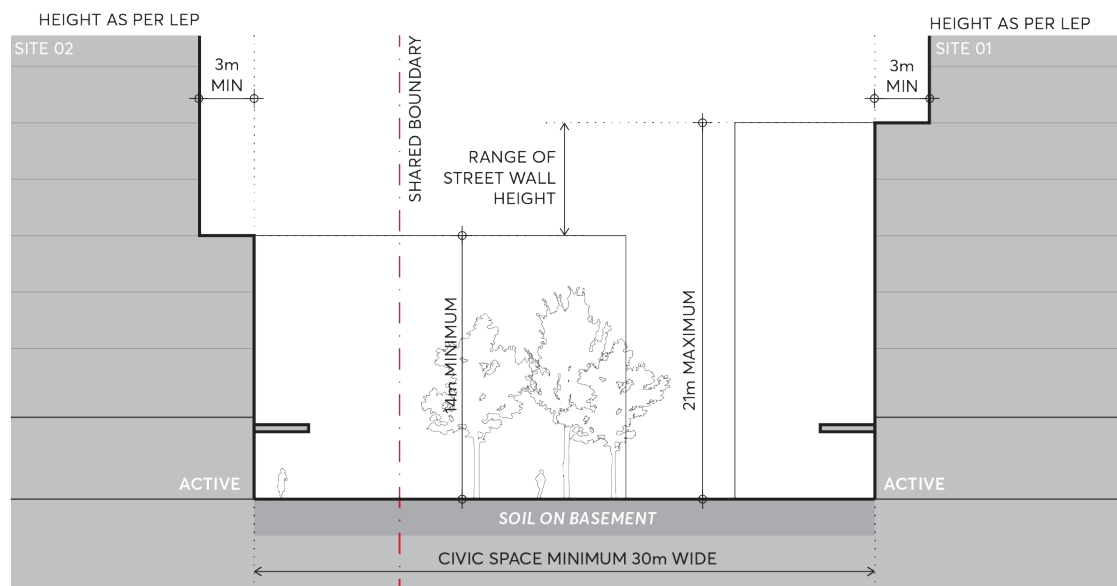

Figure 9.5.11.14 – Civic Space (Section J) Setbacks and Street Wall Height

- C.06 Development on the eastern side of Church Street must provide a setback to neighbouring properties within the North-East Parramatta Precinct (refer to future Section 8.3.10 of this DCP). Side setbacks must comply with Figure 9.5.11.4 - Church Street North Special Area Required Setbacks and Built Form and ensure consistency with building separation objectives of the Apartment Design Guide.
- C.07 Where possible, buildings should be designed so that the short edge of towers may be orientated towards the North Parramatta HCA and Sorrell Street HCA to minimise their impact on these areas of heritage significance. Where possible, towers should be aligned across the block to create generous views to sky between towers when observed from either HCA, as per Figure 9.5.11.15.



Figure 9.5.11.15 – Spaces between towers to enable views to sky

C.08 Towers must have a minimum separation of:

- a) 18 metres between primarily east-west facing facades as per Figure 9.5.11.16 and
- b) 24 metres between primarily north-south facing facades as per Figure 9.5.11.17.

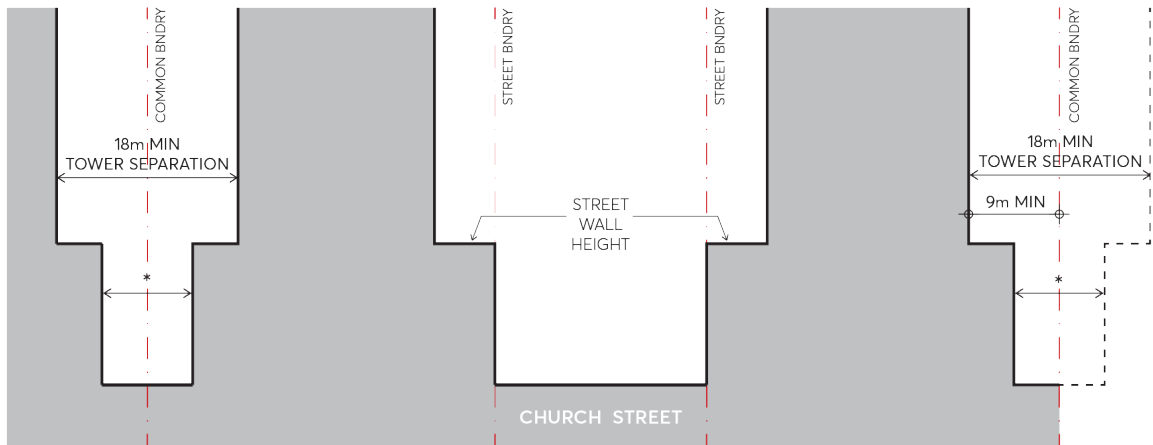

* LOWER LEVEL SETBACK CONDITION DETAILED BY FIGURE 9.5.11.4

Figure 9.5.11.16 – Tower separation between primarily east-west facing facades

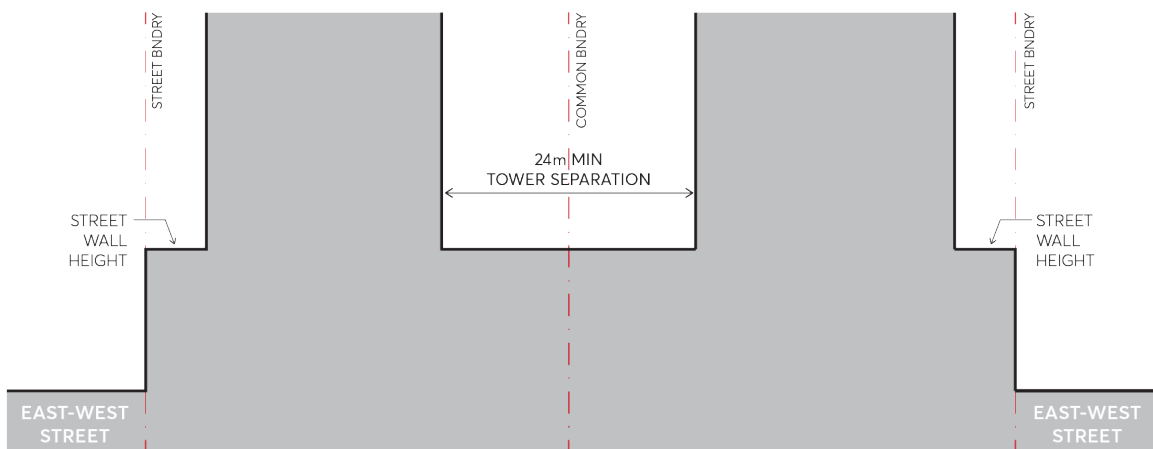

Figure 9.5.11.17 – Tower separation between primarily north-south facing facades

- C.09 All development containing a residential component must provide a minimum deep soil area equal to 7% of the total site area. All deep soil zones must have a minimum dimension of 6 metres x 6 metres.
- C.10 Where green coloured areas are shown in Figure 9.5.11.4 - Church Street North Special Area Required Setbacks and Built Form it is desirable that these areas be used as a communal courtyard and/or landscaped area.
- C.11 Deep soil is to be delivered primarily within the street setback zones and mid-block locations where they will be collocated with communal open space at ground.
- C.12 Where the street setback adjoins active uses, the setback zone is to be provided as publicly accessible space and designed as an extension of the footpath. All stairs and ramps on active frontages must be internalised to ensure the public domain and front setback zones are kept relatively level, accessible and uncluttered.
- C.13 Driveways servicing new development are not permitted on Church Street and Villiers Street.
- C.14 Pedestrian and vehicle conflict are to be minimised with limited vehicle crossings to the public domain. Crossings are to be generally in accordance with Figure 9.5.11.4 - Church Street North Special Area Required Setbacks and Built Form.

9.6 HERITAGE

This section of the DCP should be read in conjunction with Part 7 – Heritage and Archaeology (including Section 7.8, which addresses Aboriginal cultural heritage, Section 7.10 – Heritage Conservation Areas) and Section 5.3.4 – Tree and Vegetation Preservation in Parramatta DCP 2023.

This section of the DCP outlines Council's integrated approach to protecting and celebrating heritage within a collective urban form that has a strong focus on the pedestrian experience. These controls apply to all land in the Parramatta City Centre, not just sites containing a heritage item or next to a heritage item, because heritage items in the City Centre form a collective network of heritage places that together enliven and enrich the city.

This section must also be read in conjunction with relevant heritage inventory sheets, the [Australia ICOMOS Burra Charter 2013](#), relevant heritage studies, and any heritage guidelines.

9.6.1 GUIDING PRINCIPLES

For over 60,000 years, the area comprising present day Parramatta has been occupied by the Burramattagal people, a clan of the Darug, who first settled along the upper reaches of the Parramatta River. The heritage of Parramatta includes places and items that are important to the local Aboriginal community or Aboriginal people of NSW. These are places or objects that people have a connection to, both physically and spiritually.

As the second town to be established on the continent, and the first to be planned, Parramatta has its roots in the earliest days of the British colony. It was a seat of government, the landing place for convicts, and the centre of administration through the British colonial period to 1840. However, Aboriginal people continued to have a strong relationship with the area and Parramatta has always been an important meeting place. Aboriginal people have a very close and special connection to a number of institutions in Parramatta, including the Native Institution, Parramatta Gaol, Parramatta Park, and the Women's Factory.

Parramatta grew into a city in the mid nineteenth century, was fully developed in all its civic institutions. That it retains so much of its heritage is evidenced in the listing of many heritage items at Local, State, National and World Heritage levels, and these should be capitalised upon and strengthened in any future development. The numbers of cities in the world that have items of World heritage significance are few, and Parramatta finds itself in unique company on a global scale. Its heritage is one of its key attributes and one that distinguishes it from other cities.

Parramatta was a town planned with its civic functions from the earliest days of its settlement. The city was given a defined grid both north and south of the River – George and Church Streets being the most significant - and a suite of civic buildings and institutional precincts within and without the grid. Commercial and residential buildings were also built. The totality of the City's heritage – its streets and spaces as well as its buildings - provides a rich network in which to read the layers of history. This holistic vision is important for any future planning in and around the Parramatta City Centre – the next layer of its history. The conservation and enhancement of its heritage, and new development that responds appropriately to its heritage, will result in a City Centre in which the present day will occupy its place in the built history of Parramatta, and of which future communities can be proud.

A challenge for Parramatta is to retain the authenticity and setting of its heritage amidst new large scale, high-rise development, particularly as its heritage buildings are generally small in scale. Heritage places in the City Centre range from individual items such as churches, halls, banks, cottages, and rows of shops, to groups and precincts comprised of related heritage items and spaces. Important groupings of heritage items include those of Centenary Square, and the masonry commercial buildings at the intersection of Church and Macquarie Streets.

Heritage in Parramatta must not be sidelined, isolated, swamped or ignored, but rather integrated with the new fabric of a thriving city environment. Its heritage places and the connections between these places, distinguishes the Parramatta City Centre from other areas, creating local identity and visual vitality, not only helping the City be more people-centred, but also delivering economic benefits. There is the opportunity for the new wave of development to support the conservation of heritage places. In addition, the retention of heritage buildings enhances the sustainability of the City, by conserving embodied energy and by providing a diversity of tenancy and dwelling types.

Heritage places in Parramatta City Centre include places such as heritage items, conservation areas, archaeological sites, Aboriginal cultural heritage sites, cultural landscapes, and heritage precincts. It is of vital importance that the heritage values of a place are understood at the earliest design stages of any development. These heritage values are not only those embodied in the fabric of a heritage place, but also in its context, and in its relationships with the broader City Centre. The identification and protection of special heritage precincts, the retention of adequate space around heritage places, the use of tree canopies to provide a setting for heritage items as well as a visual break between small items and larger development, and ensuring that new buildings form a neutral backdrop to heritage places, together will serve to protect the heritage of Parramatta.

The [Australia ICOMOS Burra Charter 2013](#) provides guidance for the conservation and management of places of cultural significance (cultural heritage places) and is useful tool in helping to make decisions about planning for development affecting heritage places.

For sources on contextual heritage design, architects and designers can consult [Design in Context](#) by the NSW Heritage Office and [Design Guide for Heritage](#) by Heritage NSW and Government Architect NSW.

The following principles apply to all development in the Parramatta City Centre:

- P.01 Heritage listed places are retained, conserved, and enhanced.
- P.02 To conserve Aboriginal cultural heritage.
- P.03 The heritage values of a heritage place, as well as the contribution of the broader context, including views, and the immediate setting, to the heritage values of the place (the relationship of a heritage place to its area), are understood prior to making decisions about changes to a place, including new development.
- P.04 New development situated alongside existing heritage places is accommodated in a way that is respectful and appropriate, and in a way that will enhance the heritage values of a place.
- P.05 The adaptation of heritage buildings is sensitively undertaken to avoid harm to their heritage significance while allowing buildings to meet changing needs.

- P.06 New development is carefully designed to protect and enhance the setting of heritage places and to acknowledge and strengthen the relationships between heritage places in the City Centre.

9.6.2 UNDERSTANDING THE PLACE

An understanding of the heritage significance of a place and its relationship to its context is crucial to directing the nature of change that would be appropriate for a heritage place and its setting. An informed design response relies on first understanding these heritage values and then addressing opportunities and constraints that arise from these.

Objectives

- O.01 Ensure that the nature of change to a place is determined by a proper understanding of its heritage significance.
- O.02 The nature of change to a site within the vicinity of a heritage item, within a heritage precinct, or which has a historical or visual relationship with a heritage item or conservation area, must be determined by a detailed understanding of the contribution the subject site makes to the heritage item or conservation area.
- O.03 A development proposal must demonstrate that a detailed analysis has been undertaken of the relationship of the subject site to its context and to other heritage places in the Parramatta City Centre.

Controls

- C.01 The Outstanding Universal Values of the World Heritage site of Australian Convict Sites, Old Government House and Domain and the National Heritage Values of the Old Government House and the Government Domain – Parramatta must be conserved and enhanced.
- C.02 The heritage significance of places listed on the NSW State Heritage Register must be conserved and enhanced. Work must be guided by the policies of a conservation management plan (or similar) which is preferably no more than 5 years old, and in accordance with its State Heritage Register listing.
- C.03 The heritage significance of local heritage places must be conserved and enhanced. The work must be guided by the management recommendations set out on Council's heritage inventory sheet for the place, or in a relevant heritage management document such as a conservation management plan that Council has found acceptable.
- C.04 A heritage impact statement must be submitted for work that will affect a heritage item or heritage conservation area.
- C.05 The heritage impact statement must include an assessment of significance undertaken in accordance with Heritage NSW guidelines and an updated heritage inventory sheet prepared using the Heritage NSW template. The assessment of significance must include a grading of significance of the component parts of the places – its spaces, fabric and landscape etc. The assessment of significance must encompass the Aboriginal cultural heritage values of the place.

- C.06 The heritage impact statement must include an analysis of the relationship of the subject site to its setting and to its broad context (such as other heritage places in the City Centre). Analysis of the existing and proposed urban, historic, scale and visual relationships within the immediate, street and area settings relating to the heritage place must be undertaken. The local and city wide context must be demonstrated by drawings in plan and in section at a range of scales, so that the heritage elements, and the spaces they inhabit, are well understood. The area of context of items and conservation areas must be large enough to capture all potential impacts.
- C.07 An archival photographic recording and measured drawings must be submitted prior to the demolition of any building listed on the Australian Institute of Architects NSW Register of Significant Architecture, the National Trust Register, a s170 register (as made under the auspices of the *Heritage Act 1977*), a place registered by DOCOMOMO Australia or which is over 50 years old.

9.6.3 HERITAGE RELATIONSHIPS

The potential heritage impact of a proposed development is influenced by many factors, including the type, scale, and context of a proposal. A useful way to consider the impact of a new development upon heritage items and heritage conservation areas is to consider the relationship that will exist between these places and any proposed new development. Contemporary innovative design will respect the heritage values of a place while adding a new layer of architectural design, enhancing the diversity the City Centre as layers of well-designed buildings result in attractive and welcoming streetscapes.

The conservation of heritage significance will involve identifying, conserving, restoring or creating these relationships in a way that retains and enhances the significance of a heritage item or heritage conservation area.

Relationships with heritage items and heritage conservation areas with their urban context (setting) are considered to operate primarily in four ways:

- Urban relationships such as mode of address to the street, and relation to historic subdivision pattern.
- Historic relationships such as historic space around the item and to other heritage places, its relationship to the natural landscape, and the names of items and places.
- Scale relationships, usually assessed in terms of height, bulk and setbacks.
- Visual Relationships, comprising views to and from the heritage item, and the setting of a heritage item.

Where the relationship between a heritage item and its setting contributes to the significance of a heritage place, this relationship must be preserved. New development should complement the heritage place and leave a valuable legacy for the future. Good contemporary design respects heritage values. The careful consideration of scale, massing, materials, colours, and details is critical when designing within a heritage context. The appropriateness of a particular strategy to create an acceptable relationship between a new development and a heritage item will be dependent upon the particular features of the heritage item, such as its architectural style, height, form, and street address.

The retention and conservation of a heritage item at the expense of its dignity is not an acceptable outcome. An appropriate relationship requires: the protection of important aspects of a heritage item and landscape features; providing appropriate space around an item commensurate to the scale and typology of the item; modulation of the building form to create an appropriate scale; careful design of architectural elements; appropriate landscaping; and, the use of suitable materials and colours. Development that overhangs a heritage item will reduce the significance of that item and is not acceptable in any circumstances.

The relationship of a heritage item to its ground plane is a key element in the historical and visual qualities of a place. It is important that heritage items are not isolated from their context by either raising or lowering the surrounding ground plane in a way that disrupts significant relationships.

Setbacks are an important attribute of an appropriate setting for a heritage item or for buildings in a conservation area. Appropriate setbacks create a positive space for heritage items. Setbacks from all sides of a building need to be considered, side and rear setbacks as well as street front setbacks.

Objectives

- O.01 Create appropriate relationships between new development and heritage items and conservation areas, in a way that retains and enhances the heritage value of a place and the Parramatta City Centre.
- O.02 Ensure that the relationship between places comprised of linked buildings and spaces are maintained where this conserves and enhances heritage values.
- O.03 Ensure that a setting which contributes to the heritage values of a heritage item or conservation areas is retained.
- O.04 Ensure that heritage items retain their physical and visual relationship with the existing ground planes of the site and the immediate setting, as well as with the sky.
- O.05 Ensure that setbacks help to provide heritage items with a visual context that responds to the historic relationships of these places to their setting and allows heritage items to be visually prominent elements comfortably situated in relation to the spatial organisation of new development.

Controls

- C.01 Existing positive relationships on the site of a heritage item and positive relationships between a heritage item and its broader context as well as its street, must be conserved.
- C.02 New development must not isolate a heritage item from its immediate surroundings where these surroundings contribute to its heritage value and setting, nor diminish the contribution of a heritage item to its context.
- C.03 New development must not physically overhang a heritage item or overhang the space that provides a positive visual curtilage for the item, nor have a visual perception of overhanging. The roof of a heritage item as well as the visual curtilage of the heritage item must be open to the sky.

- C.04 The ground below a heritage item, or trees which contribute to the heritage values of the place, including its setting, must not be excavated.
- C.05 New buildings must not be designed to step away from heritage buildings like a ziggurat, but must have vertical walls – with the line of the wall located such that the space around a heritage item is clearly defined and there is a positive visual and physical curtilage around the heritage item.
- C.06 The architectural character of a heritage item, including important architectural elements such as massing, form, parapets, roof lines, gutter lines, materials, colours and the like, must be considered in the design of new development.
- C.07 Priority must be given to uses for heritage items that involve less change to significant fabric than uses that require more change.
- C.08 New development must ensure that its relationship with a heritage item will not require the necessity for upgrades to the heritage item such that there will be an adverse impact on the heritage significance of a heritage item.
- C.09 New uses for heritage items resulting from new development must not adversely affect the amenity of a heritage item for users.
- C.10 Those parts of a new development that form the backdrop to a heritage item must be designed so that the visual prominence of a heritage item is retained and, preferably, enhanced. A discordant visual relationship is not acceptable.
- C.11 The modulation, proportions and rhythm of the design of development in the vicinity of heritage items must respond to the scale and visual character of heritage items.
- C.12 New buildings must not use imitation period details as a device to try and blend with historic places.
- C.13 The existing ground plane of a heritage item and its immediate setting must be retained. Heritage items must not be visually isolated by changes in ground planes.
- C.14 Where flood risk management requires raised levels, a sufficient extent of existing ground plane must be retained around the heritage item in order to ensure an appropriate setting, including the deep soil area of any trees.
- C.15 Where original ground levels have been raised such that they detract from the setting of a heritage item, original levels must be reinstated.
- C.16 Materials, finishes and colours for new developments must make a positive contribution to the heritage values of a heritage item and its setting, and must not be visually intrusive.
- C.17 New developments must seek to preserve historic setback patterns if this conserves and enhances the heritage values of the place.
- C.18 Setbacks for new development must be sufficient to provide a heritage item with a surrounding space of appropriate scale. The height and bulk of a proposed new building in relation to the scale of heritage items and conservation areas must be considered in determining appropriate setbacks.
- C.19 Setbacks must ensure views to and from a heritage item are protected, and enhanced where they have been lost.

- C.20 Landscape features that contribute to the heritage values and setting of a heritage item and conservation area must be retained and enhanced. In the case where existing trees contribute to the heritage values and setting of a heritage item and conservation area, a deep soil area beyond the perimeter of the tree canopy must be retained to the satisfaction of Council, and a basement must not be built below this area.
- C.21 In the case of an historic house, a landscape area, preferably deep soil, large enough for trees with spreading canopies taller than the roof of the house, must be provided behind and at the side of the building in order to convey the original detached nature of the dwelling and a garden setting. The landscaping in front of the house, including a front fence if appropriate, must be designed to enhance the heritage values of the house.
- C.22 Signs must be located appropriately in relation to the architectural design of the façade and in locations where they were traditionally placed e.g. in recessed panels designed to contain signage. Signs must not conceal architectural features or details which contribute to the significance of the heritage place.
- C.23 Signage adjacent to a heritage item must not obscure or adversely affect the setting of the heritage item.

9.6.4 DEMOLITION

Demolition of heritage items or contributory buildings in conservation areas is not supported, nor is the retention of only the façade of a heritage item. Demolition of parts of a building that have little or no significance is acceptable so long as the replacement development does not have an adverse impact on heritage values.

Objectives

- O.01 Ensure heritage items and contributory properties in conservation areas are retained.
- O.02 Ensure components of a heritage item or conservation area that contribute to the heritage values of the place are retained and conserved.

Controls

- C.01 Heritage items and contributory properties in conservation areas must not be demolished or destroyed through neglect. The poor structural or aesthetic condition of a heritage item or contributory building will not be considered justification for permitting demolition.
- C.02 Components of a heritage item and a conservation area that contribute to the heritage values of the place must be retained and conserved.
- C.03 The three dimensional form of the primary part of a heritage building and any significant part of the building, including its roof, must be retained. The retention of only the façade of a heritage item is unacceptable under any circumstance.
- C.04 Heritage items must not be dismantled with the intention of reassembling following building works or relocating on a new site. Heritage items must remain insitu, and the methodology for

the protection of the heritage item and any landscape components that contribute to its heritage values, during construction works included in the heritage impact statement.

9.6.5 AMALGAMATION OF LOTS

The majority of sites in the City Centre will require amalgamation before redevelopment becomes viable or appropriate. However, the ability of sites to be amalgamated is not the only criteria as to whether a development may be suitably accommodated on a site. New developments must seek to recognise heritage items as vital parts of a rich urban fabric.

The historical pattern of the grid of Parramatta City Centre is characterised by small lots. Some amalgamations have the potential to significantly prejudice the potential for an appropriate relationship between new development and a heritage item, simply because of an unsuitable site shape, dimension and/or configuration that cannot be overcome by design solutions. In some cases, all proposed options for a site may in fact be inappropriate, with some sites simply unable to accommodate a proposal of a certain size, and further amalgamation may be required to provide an appropriate setting for a heritage item. The direction in which amalgamations occurs may also have a determinative effect on the future urban form.

Development proposals involving lot amalgamation including or adjacent to a heritage item must address specific requirements for the preparation of a conservation management plan.

Objectives

- O.01 Prioritise heritage conservation considerations in assessing developments that amalgamate heritage sites.
- O.02 Ensure developments respect the primary street address of a heritage item and, where appropriate, maintain the legibility of the historic lot boundary.
- O.03 Ensure that amalgamation does not result in an adverse impact on the relationship of a heritage item to its historic and visual context.

Controls

- C.01 Amalgamation must not result in the isolation of a heritage item from its immediate surroundings nor diminish its ability to contribute to the streetscape. Some sites may require further amalgamation before a development may become appropriate in heritage terms.
- C.02 Any new development that affects a heritage item must ensure an appropriate setting is maintained or created to conserve the significance of that item. Where an inappropriate relationship is found to exist between the existing and proposed developments, further amalgamation may be required to achieve an appropriate outcome.
- C.03 Where the sites of a number of adjacent heritage items are amalgamated, developments with podiums must respond to their setting so as to not conceal the historic subdivision pattern. Long, linear podiums that conceal street rhythm are not acceptable and must instead be designed to conserve the existing streetscape pattern and rhythm.

- C.04 Development must not visually join together historic buildings which were historically separate items.
- C.05 The primary street address of a heritage item must be maintained as well as an understanding of its historic context.
- C.06 Development proposals involving lot amalgamation including or adjacent to a heritage item must address the requirements of Clause 7.22 (3)(c) Managing Heritage impacts in *Parramatta LEP 2023* requiring the preparation of a conservation management plan.

9.6.6 DEVELOPMENT TO BENEFIT A HERITAGE ITEM

Any development that derives benefit from a heritage item (such as gained floor space or reduced setbacks) must in turn benefit that heritage item.

Some historic buildings have been subject to insensitive alterations, which may have resulted in an altered building form, colour, or street presence. In many cases, the actual historic nature of the building may be totally disguised. Previous unsympathetic changes should be remedied where the opportunity exists.

An important way of conserving a heritage building is for it to have a viable use. The best use for a building is usually the one for which it was built. Where this is not possible, a use which requires minimal alterations should be found. Where a viable use is not able to be found, it is preferable for a building to be "mothballed" temporarily rather than have alterations carried out that result in significant loss of original fabric.

Heritage items may require to be upgraded to meet contemporary building standards. Upgrades must be undertaken in a way that conserves the maximum significance of the heritage item.

In order to create a positive relationship between new development and a heritage item, the particular properties of a proposed material must be considered, and whether such a choice of materials and colours will compliment or adversely impact the heritage significance of a place or item or its setting.

Landscaping, in particular trees, can play an important role in providing a sympathetic scale in the immediate vicinity of a heritage item or conservation area, and to visually "soften" the hard edges of surrounding built form.

Objectives

- O.01 Ensure that the heritage values of a heritage item are conserved and enhanced.
- O.02 Ensure that advantages and incentives to development obtained by its relationship to a heritage item benefits the heritage conservation of the item.
- O.03 Ensure that the recovery of the authenticity of a heritage item, and the minimisation of changes to heritage significant fabric, spaces and landscaping, is given priority in the site planning and design of development proposals.
- O.04 Building upgrades required to meet contemporary building standards are undertaken in a way that avoids adverse heritage impacts.

- O.05 Ensure that changes are sympathetic to the heritage item and additions connect to the heritage item in a way that is considered and respectful.
- O.06 Ensure that existing landscape features which contribute to the heritage values of a place are retained and enhanced.
- O.07 Ensure that new landscaping enhances the setting of a heritage item.

Controls

- C.01 Any development that derives an advantage from a heritage item must bestow a conservation benefit on the heritage item. The nature of this benefit must be agreed with Council.
- C.02 Priority must be given to uses that require no change to significant fabric and spaces, or only minimal change, in order to help conserve the character, significant fabric, spaces, and setting of a heritage item.
- C.03 Development must enhance a heritage item by removing unsympathetic alterations and additions and reinstating missing details, building and landscape elements, and original internal spaces.
- C.04 Modifications to original fabric, spaces and landscaping must be negligible or limited. Change to significant fabric, landscape elements, or spaces must be minimised by locating new work away from these components.
- C.05 Additions must be joined to a heritage item in a way which allows the form and important components and details of the heritage item and its setting to be retained.
- C.06 Repairs and alterations to the historic section of buildings must use traditional techniques and materials unless alternative techniques and materials can offer substantial conservation benefits. Relevant information, including detail drawings, must be provided with the development application.
- C.07 Building upgrades must be designed to complement the character of a heritage item. New elements associated with building upgrades must be located on parts of the building that are new, or have experienced change, and must be discretely located so as to have limited visibility.
- C.08 Colour schemes must have a hue and tonal relationship with traditional colour schemes appropriate to the period and style of the building in order to ensure significance is enhanced. Or the original colour scheme, if known, can be reinstated.
- C.09 Original face brickwork and sandstone must not painted, rendered or re-skinned.
- C.10 New landscaping designed to enhance the setting of a heritage item must be an integral component of new development. New landscaping must incorporate trees with spreading canopies behind and around heritage items where these items were originally set in a garden, or where trees would enhance the setting by providing a visual "break" between the heritage item and the new development. The soil areas for new trees and other plants must be set level with the ground plane around the heritage item and not in raised planters.
- C.11 Existing signage that is deemed to have heritage value must be retained and repaired, and not altered or obscured, including historic painted signage.

- C.12 A detailed schedule of conservation works must be prepared for heritage items and submitted with the development application.

9.6.7 INTERPRETATION

In some instances, on-site interpretation is a good means of communicating the heritage significance of a heritage item. However, interpretation needs to be carefully considered and installed.

Interpretive opportunities may include new features or reconstructions (such as the creation of a garden, or the re-opening of a doorway) or responses to archaeological evidence (such as the acknowledgement of earlier footings in a new paving design). Care must be taken in the interpretation of a place to ensure that the interpretation itself does not detract from the significance of the place.

Objectives

- O.01 Utilise interpretation in order to assist in the understanding of the heritage significance of a place.

Controls

- C.01 Interpretation must not be considered as a satisfactory alternative to the retention of an item.
- C.02 Interpretation must be consistent with an appropriate Heritage Conservation Management Plan or other relevant policy guidelines for the item.
- C.03 Interpretation must not reduce or obscure the heritage significance of the item or place.
- C.04 Interpretation must be installed with no damage or impact to significant building fabric and must be reversible.
- C.05 The appropriate treatment of a heritage item's fabric, spaces and setting must be used as a means for the interpretation of each of the significant values of the item.
- C.06 Important archaeological features of the site must be interpreted.
- C.07 An interpretation plan must be submitted with any development application that includes works to a heritage item or is located on the site of a heritage item.

9.7 FLOOD RISK MANAGEMENT

Parramatta City Centre sits in the floodplain of both the Upper and Lower Parramatta River Catchments, Clay Cliff Creek and other tributaries. The City is prone to mainstream (or river) flooding events and local overland flow flooding. All of this is 'flash flooding' with short warning times for building occupants and people in the streets and public spaces.

For many sites, conventional (horizontal) evacuation of a building during a flood event is suitable. For sites where this is not possible, taking refuge within buildings above the Probable Maximum Flood is required. This is termed 'Shelter in Place'. This Section explains how these alternatives are pursued for new and upgrading development.

This section provides the guidance for early consideration of integrated built form solutions that address flood risk, flood safety and good design.

The controls within this section apply to flood prone land in the Parramatta City Centre. This includes land identified as being within the 'Floodplain Risk Management Area' on the Floodplain Risk Management Map in *Parramatta Local Environmental Plan 2023*.

This section should also be read in conjunction with:

- Section 5.1.1 – Flooding and where there is an inconsistency, this section prevails. Refer also to Section 9.3.5.2 – Flood Affected Sites.
- Council's [Floodplain Risk Management Policy and Plan](#) as required by the NSW Flood Policy and NSW Floodplain Development Manual.

Note – A word or expression used in this Section has the same meaning as it has in the NSW Government's [Floodplain Development Manual 2005](#) unless it is otherwise defined in this DCP.

Objectives

- O.01 The flood environment, its risks and consequences are to be understood and responded to accordingly.
- O.02 Levels of flood risk and threats to personal safety and property present for particular developments are to be minimised or significantly reduced with appropriate responses to this environment.
- O.03 Council is to provide direction, guidance and regulation for the safe and sustainable development on all land affected by flooding.
- O.04 Buildings and the uses they contain are to be compatible with the identified flood risk.
- O.05 Early site planning and consideration of flood conditions is essential to achieve an integrated flood response that manages flood risk and provides optimum development design outcomes and interface with the public domain.
- O.06 Adequate, safe flood conveyance and management of floodwaters is to be achieved, while providing for the rehabilitation, conservation and embellishment of floodways and other flood affected lands where appropriate.

Controls

- C.01 Flood Hazard Modelling and hazard, risk and safety assessments for all development involving the construction of a new building or significant alterations to an existing building, and or intensification of a use is to address the PMF and floods greater than the 1% Annual Exceedance Probability (AEP) as part of the Development Application (DA), particularly where there is a potential risk to life.
- C.02 Where this information is available, Council requires an Applicant to make a Flood Information Enquiry. The information supplied to an applicant via a Flood Information Enquiry will form the basis of the DA flood assessment.
- C.03 In some cases, Council may require an applicant to prepare an additional flood study, for example for special local conditions, or if the proposed development is of a form or type that requires more site-specific flood modelling. Where Council requires an applicant to submit an additional flood study, the applicant must use parameters provided by Council to prepare the flood study.

9.7.1 ASSESSMENT AND MINIMISATION OF FLOOD HAZARDS, RISKS AND POTENTIAL FOR HARM

Risk and Merit Assessment

The NSW Floodplain Development Manual (FPDM) requires councils and consent authorities to adopt a 'risk-based approach' to floodplain development and mitigation of potential harm. This is based on a 'merit assessment'. The FPDM sets out guidelines for this process and Council follows this approach.

The FPDM defines merit approach as:

"The merit approach weighs social, economic, ecological and cultural impacts of land use options for different flood prone areas together with flood damage, hazard and behaviour implications and environmental protection and well-being of the State's rivers and floodplains.

"The merit approach operates at two levels. At the strategic level it allows for the consideration of social, economic, ecological, cultural and flooding issues to determine strategies for the management of future flood risk which are formulated into Council plans, policy and Environmental Planning Instruments (EPIs). At a site specific level, it involves consideration of the best way of conditioning development allowable under the floodplain risk management plan, local flood risk management policy and EPIs."

"Risk of harm" is the product of likelihood and consequence. The likelihood is usually 1% AEP; and the consequence or harm describes the impact of the flow of floodwaters on people, property, buildings, etc, and the environment. Development proposals that significantly increase risk of harm to occupants and other people, or to property within or off the development site, or to the environment will not be supported.

Hazard or 'hydraulic hazard' describes the behaviour of floodwaters and particularly the amount of flow, the extent, velocity and depth of that flow. This is primarily modelled for 1% AEP floods but may also be required for PMF conditions particularly in regard to shelter in place planning and for risk assessment of 'sensitive' and 'critical' uses.

The hazard categories H1-H6 briefly describe these impacts (see below) and shows the relationships between floodwater velocity and depth and consequent hazard for each level. This methodology also summarises the risk of harm for each hazard level.

Such hazard, risk and safety assessments will underpin Development Application assessment by Council and must be adequately addressed in any DA submission affected by mainstream or overland flow flooding. Often more detailed examination of hazard, risk and potential harm for a specific site and its proposed development will be required.

Objectives

- O.01 Hazard, risk and safety assessments are required to demonstrate how risk and potential harm to people, property, buildings, and the environment from floodwaters will be mitigated.
- O.02 A risk-based approach to floodplain development and mitigation of potential harm based on a merit assessment consistent with the Flood Plain Development Manual (2005 or as updated) is required.

Controls

- C.01 All development involving the construction of a new building or significant alterations to an existing building, and or intensification of a use must be supported by flood hazard modelling that is:
 - a) based on the 'General Flood Hazard Vulnerability Curves' in Figure 9.7.1.1 for the 1% AEP flood and the PMF.
 - b) is assessed in terms of the following hazard categories and risks of harm:
 - H1 – generally safe for people vehicles and buildings.
 - H2 – unsafe for small vehicles.
 - H3 – unsafe for vehicles, children and the elderly. This includes all floodwaters greater than 0.5m depth.
 - H4 – unsafe for people and vehicles.
 - H5 – unsafe for vehicles and people. All buildings vulnerable to structural damage. Some less robust building types vulnerable to failure.
 - H6 – unsafe for vehicles and people. All building types considered vulnerable to failure.

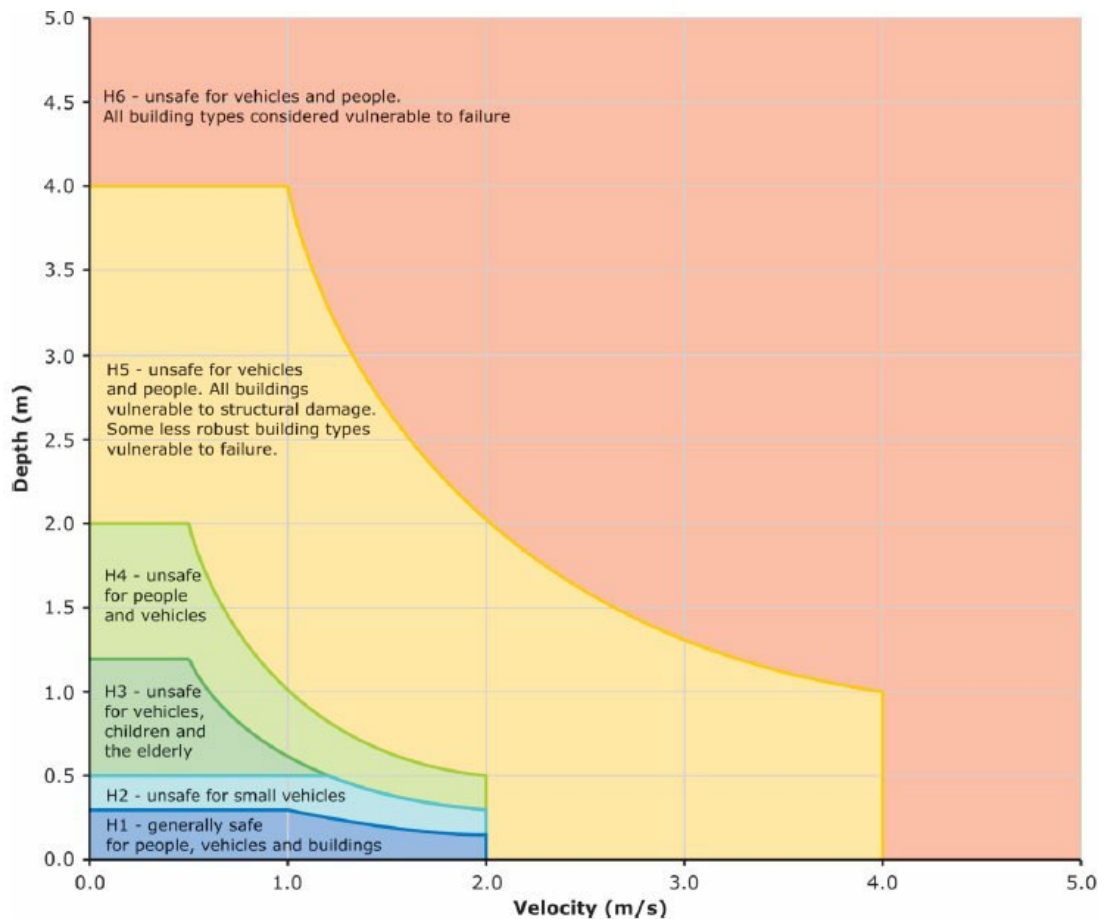

Figure 9.7.1.1 – General flood hazard vulnerability curves ²

² Source: Australian Disaster Resilience Guideline 7-3 Flood Hazard (AIDR 2017) See also: Australian Rainfall and Runoff (2017, 2019)

C.02 All development involving the construction of a new building or significant alterations to an existing building, and or intensification of a use is to be supported by a merit-based flood hazard and risk assessment that:

- a) Presents evidence-based analysis of the hazard, risk and harm to occupants and those in the surrounds and demonstrates how harmful factors will be mitigated.
- b) Includes information on the following aspects as necessary, to enable Council to assess risk and potential for harm.
 - 1% AEP and 5% AEP and PMF flood levels, flood extents, flow rates, depths and velocities and hazard conditions for mainstream and overland flow floods.
 - Modelled hydraulic hazard levels, (H1-H6), extent and behaviour for 1% AEP mainstream and overland flow floods.
 - Warning times and duration of flooding.
 - Available warning systems (if any).
 - Characteristics and vulnerabilities of future occupants.
 - Likelihood of multiple storms – and multiple flood peaks.
 - 'Horizontal' evacuation pathways including accessibility considerations.

- 'Vertical' evacuation opportunities and shelter in place facilities above the PMF.
- Emergency services access availability.
- Local terrain.
- The development in context.
- The proposed use and occupation of the development.

9.7.2 LAND USE AND BUILDING LEVELS

Objectives

- O.01 Ensure the design of the building including floor levels and indoor and outdoor uses are appropriate for the flooding environment, particularly with regard to flood hazard and risks.

Controls

- C.01 To achieve a safe environment for occupants within a building, residential habitable rooms must be set at or above the Flood Planning Level (FPL), which is the adjacent 1% AEP flood level plus a 500mm freeboard safety factor.
- C.02 The following uses within a building will not be supported below the FPL.
- a) Residential habitable rooms or uses, including those relying on flood gates, flood doors, barriers, crests, walls, windows or other physical barriers to exclude floodwaters up to the FPL.
 - b) Gathering places such as places of worship and classrooms.
 - c) Uses such as child care centres, aged care facilities.
 - d) Storage of valuable items including important records, archives and office files.
- C.03 Indoor, non-habitable floor space and corresponding uses may be permitted below the FPL, subject to a satisfactory flood hazard and risk assessment and appropriate flood mitigation measures. Such uses may include:
- a) Basement car parking and bicycle storage, with floodwaters excluded up to the PMF, subject to compliance with the controls in Section 9.7.8 – Car Park Basements in Flood Prone Areas.
 - b) Plant and equipment, pumps, generators, batteries (all flood proofed as necessary if relied upon for shelter in place purpose).
 - c) Tanks, for water supplies, sewage holding, on site Detention, WSUD, liquid fuel, gas (all flood proofed as necessary relied upon for shelter in place purpose).
 - d) Loading docks, solid waste facilities, garbage and recycling transfer.
 - e) Short stay parking, taxis, deliveries, couriers etc.
 - f) Storage and warehousing of 'non-valuable items' will be assessed on merit.

- C.04 Outdoor uses below the FPL may be permitted provided the design is flood risk responsive and will not unreasonably expose patrons to harm from high hazard conditions (Hazard Level H3 or greater). Development Applications for outdoor uses below the FPL must be supported by an effective Flood Emergency Response Plan and may include:
- outdoor cafes, restaurants, bars
 - kiosks,
 - clubs,
 - display areas, and
 - outdoor stages, cinemas and theatres.
- C.05 Commercial and retail development at street level that is below the FPL within a building that occupies land subject to flooding in a PMF event may be permitted if:
- a) a satisfactory flood hazard and risk assessment is undertaken and appropriate flood mitigation measures are incorporated accordingly, and
 - b) the development is designed to minimise damage to property and risk to life, and
 - c) the development is not subject to or surrounded by high hazard flooding in the 1% AEP event, unless there is a flood free pedestrian access to a building (which could be another part of the same building) which is outside of the high flood risk precinct, and
 - d) any storage of goods below the FPL is only permitted where they are protected from floods up to the FPL.
- C.06 Commercial and retail development within a basement below the FPL is, in general, not permitted within a building that occupies land subject to flooding in a PMF event.
- C.07 Notwithstanding C.06, Council may at its discretion permit some types of commercial and retail development within a basement of a building below the FPL that occupies land subject to flooding in a PMF event if:
- a) a satisfactory flood hazard and risk assessment is undertaken and appropriate flood mitigation measures are incorporated, and
 - b) occupants and visitors will not be subject to significant risk of harm caused by flooding at or near the site in a PMF event should any of the active flood barriers fail, and
 - c) the basement is capable of withstanding riverine and overland flow PMF forces including the weight of floodwaters potentially ponding in the basement should any of the active flood barriers fail, and
 - d) at least one access point from the basement to the shelter in place refuge is protected against a riverine PMF using passive, fail-proof barriers, and
 - e) the Flood Emergency Response Plan:
 - i. includes the information detailed in Control C.02 in Section 9.7.4 – Flood Warning and Emergency Response Planning, and
 - ii. enables occupants and visitors of the development including those in the basement levels, to have direct flood-free access from the basement to the Shelter in place within the building that is above the PMF, and

- iii. includes details of any physical flood exclusion measures in the development including procedures and practices for their operation, inspection and maintenance in perpetuity, and
- f) building access and egress does not require people to traverse hazardous floodwaters – that is Hazard Level H3 and above in the PMF, and
- g) any storage of goods below the FPL is only permitted where they are protected from floods up to the FPL.

9.7.3 SENSITIVE AND CRITICAL USES

Objectives

- O.01 Ensure sensitive and critical uses and facilities are located away from unsafe flood conditions.

Controls

- C.01 'Sensitive Uses and Facilities' and 'Critical Uses and Facilities,' as defined in Table 5.1.1.1 – Land Use Category Definitions in Section 5.1 – Water Management of this DCP are, in general, not permitted within a building that occupies land subject to flooding in a PMF event.
- C.02 Council may at its discretion permit some 'Sensitive Uses and facilities' such as a centre-based child care, hospital or aged care facility within a building that occupies land subject to flooding in a PMF event, if Council can be satisfied that:
 - a) Occupants and visitors will not be subject to significant risk of harm caused by flooding at or near the site in a PMF event.
 - b) A Flood Emergency Response Plan is planned, designed and implemented in perpetuity to provide adequate refuge for shelter in place as well as emergency services access and evacuation of the centre or facility.
 - c) Building access and egress does not require people to traverse hazardous floodwaters – that is Hazard Level H3 and above in any flood between the 1% AEP and the PMF.

9.7.4 FLOOD WARNING AND EMERGENCY RESPONSE PLANNING

Evacuation plans, flood warning systems and flood emergency response plans are all important elements for reducing risk of harm during a flood event. However, it is necessary to recognise that flood emergency response plans "...cannot be solely relied upon to be effective in all flood events and therefore cannot be considered to reduce the hydraulic hazard. At best they reduce flood risk in events where they operate effectively and as such, flood emergency response plans should not form the basis of development consent"³

Objectives

- O.01 Ensure flood warning and emergency response planning is undertaken for flood prone developments to assist in reducing risk of harm. This includes:
- Flood Emergency Response Plan (FERP)
 - Flood warning system
 - Evacuation planning (horizontal and vertical) and emergency access and Shelter In Place
- O.02 To enable Shelter In Place, or vertical evacuation as an alternative to horizontal evacuation, for certain flood affected sites, enabling appropriate development to occur, while protecting occupants during floods.
- O.03 To minimise the risk to life and property for new and renewed developments in the CBD through Flood Emergency Response Plans that consider the feasibility of horizontal evacuation, appropriate vertical evacuation or shelter in place and recognise that the difficulty of evacuation and accessing the Parramatta City Centre as a whole during major floods, and the extent of the PMF from Parramatta River, means that Shelter In Place is likely to be the basis for most individual Flood Emergency Response Plans for new and renewed developments in the City Centre.

Controls

- C.01 All development involving the construction of a new building or significant alterations to an existing building, and or intensification of a use must be supported by a FERP.
- C.02 FERPs submitted with Development Applications must include:
- both warning and evacuation measures (horizontal or vertical) for all building occupants (residents, workers and visitors) that includes the most appropriate 'safe areas' and 'safe evacuation routes';
 - measures to prevent evacuation from the site by private vehicle;
 - the most appropriate emergency response for flood and fire events that occur together;
 - a building flood emergency response plan, similar to a building fire evacuation drill, and measures to ensure this is tested at least annually;
 - a statement about the consistency of the submitted FERP with the FERP for the Parramatta City Centre; and
 - evidence of consultation undertaken with relevant state and local agencies in the preparation of the FERP.
- C.03 Horizontal evacuation measures are preferred for all building occupants (residents, workers and visitors) where the following can be satisfied:
- a) Pedestrians can evacuate safely from a building via a flood free pedestrian access on a 'rising road' to an area of refuge located above the PMF. The evacuation pathway must not require passage through deepening or high hazard (H3 to H6) floodwaters.
 - b) A pedestrian exit from a building is provided above the PMF that is accessible internally to all occupants.
 - c) Address requirements for accessibility and be available for all occupants (where possible)

- d) If feasible and beneficial, provide a link to a neighbouring building by means of an internal access or a bridge, connecting buildings and leading occupants to an exit above the PMF.
 - e) Not rely on lifts, elevators etc.
 - f) Address access into the property during floods by Emergency Services such as SES, Ambulance, Fire and Rescue.
- C.04 Where horizontal evacuation is not feasible, Shelter In Place or vertical evacuation must be provided for all building occupants (residents, workers and visitors) that offers access to a safe indoor area of refuge or 'shelter in place' above the PMF where they can remain until the flood event has passed and any subsequent disruption after the flood has been rendered safe and serviceable.
- C.05 Shelter In Place or vertical evacuation measures must satisfy the following requirements:
- a) Refuge shelters must be adequate and fit for purpose (size, design, equipment, supplies) and maintained as such in perpetuity.
 - b) Unless otherwise advised by Council, facilities must be designed for a refuge stay of at least 72 hours, with longer time periods addressed in design, equipment and provisioning.
 - c) It is recommended, and may in some cases be required, that large and high-rise residential buildings be provided with emergency back-up power, water supply and sewerage for all residential units and common facilities including lifts. This must be provided in the context of an overarching Emergency Response Plan that includes flooding, power outages, extreme weather events and other incidents.
 - d) Where the building design and back-up systems enable some residents to safely remain in their own apartments for extended periods during floods, all such residents must still have access to a communal refuge area of adequate size where support from other residents and emergency supplies are available.
- The communal safe area of refuge must be permanently provided with as a minimum:
- emergency electricity supply, and lighting,
 - clean water for drinking, washing and toilet flushing,
 - working bathroom and toilets,
 - suitable food,
 - personal washing facilities,
 - medical equipment including a first aid kit, and
 - a battery-powered radio and relevant communications equipment.
- C.06 Requirements for the communal safe area of refuge must be detailed in the Flood Emergency Response Plan supporting the DA and must address:
- a) Numbers of people likely to need the facility and consequent size, equipment and provisioning requirements.
 - b) Means to ensure ongoing services such as power, water and wastewater disposal, communications.
 - c) Long term maintenance as part of the building management system.
 - d) Dual use of the refuge area for other non-emergency communal functions (if practical).

- C.07 All safe areas of refuge (residents own apartment or a communal area) must have:
- a) fail safe access to the safe area of refuge from anywhere in the building including the basement (lift access is not allowed) that is protected from floodwaters up to the PMF by suitable flood doors, flood gates and the like; and
 - b) fail safe access to an exit/entry point located above the 1% AEP flood level plus 0.5m freeboard that enables people to exit the building during a fire and/or flood, and allows emergency service personnel to enter a building to attend to a medical emergency.

9.7.5 DEVELOPMENT IN AND NEAR FLOODWAYS, RIPARIAN ZONES AND NATURALISED CHANNELS

Objectives

- O.01 Development in and near floodways, riparian zones and naturalised channels requires careful planning and detailed design to protect occupants and people in the locality while supporting flood conveyance requirements, beneficial environmental outcomes and optimising development opportunities.
- O.02 Encourage naturalisation and semi-naturalisation of concrete floodway channels and creeks where feasible.

Controls

- C.01 Design of new waterways and rehabilitation of existing waterways and creeks must maximise habitat, ecological and landscape values, both in the aquatic and riparian environments, while ensuring hydraulic functions are not diminished.
- C.02 Development adjoining creeks and rivers must incorporate protection and conservation of riparian zones, as well as facilitating human access, amenity and public safety as appropriate.
- C.03 Where a site adjoins a creek or river, a substantial riparian buffer zone along the full site frontage is likely to be required to enable the river bank to be rehabilitated and ecological damage to be repaired. Any stormwater infrastructure in this zone must address this and not impact it negatively, either immediately, or in the long term.
- C.04 The overall development must provide for public safety, evacuation and such matters as bank stability and erosion control, riparian vegetation and so on.

9.7.6 CONTROLS FOR FLOODWAYS

Objectives

- O.01 To ensure floodways are not directed within or beneath a building
- O.02 To consider open-air floodways on a site.

Controls

- C.01 Council will not support proposals for flood flow-through or flood storage chambers within or beneath a new building.
- C.02 Council will consider on merit the use of part of the ground level building footprint for an open-air overland flow path or floodway, provided that:
- a) The floodway within and beyond the footprint is designed and maintained for public safety and risk management.
 - b) Flood hazard conditions are effectively managed to minimise risks to public safety.
- C.03 Any cantilever building element (excluding any structural support columns or similar) must have a minimum 4 metre clearance above the ground surface level of the overland flow path throughout the site to enable a landscaped open space to be created. The landscaped open space must:
- a) Be designed for low intensity and low risk pedestrian activities, recognising this is likely to be a site of 'high hazard' flash flooding;
 - b) Create a positive and safe experience for pedestrians;
 - c) Promote activity, connectivity and variety in the public domain;
 - d) Be designed having regard to aspect, height and proportions;
 - e) Be designed in conjunction with street levels to facilitate step-less access; and
 - f) Be provided with 'deep soil' and planted with appropriate tree and shrub species that are satisfactory to Council for this context.
 - g) The horizontal extent of any overhang is subject to Council approval and Urban Design requirements.
 - h) Undercrofts are generally not supported.
 - i) The cross sectional area and width of the floodway within the building footprint is less than the area and width of the floodway beyond the footprint.
- C.04 A floodway or flow path adjacent to a building must not be obstructed by permanent design elements such as walls, stairs, ramps etc. Building support columns may be acceptable. Trees and 'soft landscape', appropriate surface treatments, including paving and ground cover, may be permitted, subject to Council approval.
- C.05 Seating, tables, and small structures such as kiosks, coffee carts and market stalls may be permitted in a floodway if they are designed for public safety and do not significantly obstruct the floodway, and must satisfy the following:
- a) Such structures may be designed to collapse in floods provided they do not generate significant or hazardous debris in doing so.
 - b) Each structure must be structurally able to withstand flooding for both the FPL and full immersion conditions, allowing for waterborne debris, hydrostatic and hydro- dynamic

forces, flotation and scour. 'Withstand' may include as an alternative the ability of the structure to safely collapse without generating significant debris. 'Withstand' also includes presenting a minimum vertical surface area and maximum permeability to the moving floodwaters and associated debris. The structures may be given external protection such as with large, deep rooted trees – but this must be justified structurally and arboriculturally.

- c) must be constructed with flood compatible materials and construction methods and services such as power lines, telecoms must be waterproofed.
- d) Such structures are not to be 'habitable' rooms, as defined by the Floodplain Development Manual, and must not be used for the storage of valuable items including important records.

Note – bicycle storage is acceptable. Kiosks may be acceptable provided they do not create 'habitable' rooms, store valuable items, or significantly increase risk to the public and occupants.

- e) As these structures are not habitable rooms/floors, there is no minimum floor level.

9.7.7 CONTROLS FOR PARRAMATTA RIVER BANK AND FORESHORES

Objectives

- O.01 Parramatta River bank and foreshores require special consideration given its combination of high flood risk, high public use and environmental values.
- O.02 Careful design of Parramatta River bank and foreshores in the City Centre is required to reconcile potential conflicts arising from 'high hazard floodway' conditions while encouraging public domain use and activation.

Controls

- C.01 Design must provide for effective flood warning and evacuation pathways must be suitable for the frail, disabled and other vulnerable people.
- C.02 Buildings and infrastructure must be minimal and appropriate for this severe environment that is regularly flooded.
- O.03 'Habitable rooms' (as defined in the Floodplain Development Manual) must not be developed in such high hazard inundated areas – but some non-habitable facilities such as kiosks may be acceptable if designed appropriately. For further requirements refer elsewhere in this DCP regarding building in or near floodways.

9.7.8 CAR PARK BASEMENTS IN FLOOD PRONE AREAS

Objectives

- O.01 Ensure the risks associated with car park basements in flood prone areas are adequately mitigated.

Controls

- C.01 Council will only allow basement car parking in flood prone land if the proposal demonstrates:
- effective floodproofing and flood exclusion of the basement against all floods up to the PMF; and
 - adequate safety for occupants of the basement and building including a flood free vertical evacuation path to a safe refuge above the PMF; and
 - consistency with other Council objectives (such as traffic management).
- C.02 To seek to demonstrate the appropriateness of a basement car park within a flood prone area, the following details must be included as a minimum in the Development Application,
- Demonstration that high hazard floodwaters (H3 or greater) will not occur in a 1% AEP event in the area adjacent to the driveway.
 - The basement must be protected from the ingress of floodwater by passive measures at least up to the flood planning level. These measures are likely to include provision of a driveway crest at or above the flood planning level with associated wing / or bund walls to this level to prevent floodwaters flowing into the basement.
 - The basement must be protected from the ingress of floodwater via the driveway up to the Probable Maximum Flood level. These measures are likely to include provision of a self-triggering and self-powered flood gate at or near the driveway crest that reaches the level of the PMF, together with corresponding wing wall bunds etc. to the same PMF level.
 - The basement must be protected from the ingress of floodwater via stairwells and other openings up to the Probable Maximum Flood level. These measures are likely to include a combination of a self-closing flood doors, flood gates and bund walls. Flood doors may also be fire doors.
 - Provision of flood-free escape stairs from the basement up to a place of refuge within the building above the PMF level with adequate facilities for users during and after a flood.
 - Provision of adequate car parking for the disabled and an escape path that can be followed to safety.
 - Submission of a comprehensive Flood Emergency Response Plan incorporating all of the above.

- C.03 The Building Management System and Plan for the development must include all necessary measures to maintain, test and operate the flood protection devices including flood gates, doors and barriers, flood sensors, flood refuges and FERP.
- C.04 Subject to other controls, automatic 'stacker' car parks may be acceptable in that they substantially reduce the likelihood of people being in the basements and needing to escape from them.

Glossary

Annual Exceedance Probability AEP % per annum - likelihood or probability of a specific flood occurring in any given year.

5% AEP (formerly 1 in 20-year flood) is a statistical event to describe a flood of this size or greater occurring in any given year.

1% AEP - (formerly 1 in 100-year) flood is a statistical event (1% Annual Exceedance Probability) to describe a 1% chance of a flood of this size or greater occurring in any given year.

PMF – The Probable Maximum Flood (PMF) is the largest flood that can be predicted at a particular location, usually modelled from the probable maximum precipitation (PMP rainfall). The PMF defines the extent of flood prone land, that is, the floodplain.

Flood Hazard – A combination of velocity and depth of floodwaters that generates varying degrees of unsafe conditions and risks for people and property now categorised as H1-H6 where H3 and above are unsafe for people.

Flood Planning Level (FPL) – is the level of the governing 1% AEP flood event plus 500mm freeboard. The governing 1% AEP flood is the higher of the mainstream (river or creek) flood level and the overland flow flood level. The freeboard is a fixed safety factor which allows for modelling variation and factors such as waves and turbulence. It does not include an allowance for Climate Change.

Flood prone land – is land susceptible to flooding by a PMF event.

Climate Change is currently predicted to increase both rainfall intensity and tidal levels and must be considered in flood risk assessment.

Flash floods – Occurs when floods reach an area less than two hours after heavy rainfall. Parramatta River and its tributary creeks are subject to flash flooding.

Mainstream Flooding (or Riparian or Fluvial Flooding) – increased flow in major and minor rivers, creeks and tributaries causing a rising water level wave that usually overtops the banks. In Parramatta this is all flash flooding.

Overland flow flooding (or Pluvial Flooding) – Water that runs across the land after rainfall, before it enters a mainstream waterway. Overland flow is normally generated by intense rainfall in a localised catchment and is also flash flooding.

SES Emergency Response Classification - determined by the SES according to the impact a flood may have in a certain area based on operational issues of evacuation, resupply and rescue.

The Flood Planning Level:

- is the 1% AEP flood level plus 0.5m freeboard safety factor.
- is the required minimum finished floor level of all habitable rooms.
- is the higher of the river or creek mainstream flood level, or the local overland flow flood level - plus 0.5m freeboard in both cases.

The PMF is modelled only for river or creek flooding, not from overland flow flooding. Freeboard is not required for the PMF.

9.8 ENVIRONMENTAL SUSTAINABILITY

Sustainability and infrastructure studies undertaken for the Parramatta City Centre found that the predicted CBD growth under the development as usual scenario will result in:

- 3 x increase in energy and water demand, and
- 4 x increase in sewer loads.

This will increase greenhouse gas emissions, place increasing pressure on our energy, water and sewer infrastructure, and lock households and businesses in to higher than necessary utility costs.

The temperature increases already experienced in Parramatta, and the densification of the City Centre (less pervious surfaces, vegetation and trees, and increase in built form) mean that urban heat impacts will also increase as our city grows.

To limit the impact of this growth, it’s important to design and build environmentally sustainable buildings that reduce energy and water use, greenhouse gas emissions and urbanheat.

9.8.1 HIGH PERFORMING BUILDINGS

High energy and water performing buildings require development standards to be materially better than the national minimum regulated standards.

To deliver high performing buildings in Parramatta City Centre, these targets represent a Best in Market approach has been adopted in the *Parramatta LEP 2023*, whereby specified non-residential developments are required to perform within the top 15 percentile of similar existing building performance across Greater Metropolitan Sydney.

This approach reflects genuine best practice for energy and water performance, benchmarked in the National Australian Built Environment Rating System (NABERS) performance databases, and ensures the requirements are technically and commercially feasible. The dynamic calibration of the best in market requirements, updated through the *Parramatta LEP 2023*, will ensure the currency of the target and delivery of high performing new development.

The controls in this sub-section outline the verification requirements to demonstrate compliance with the energy and water targets in subclause 7.25 (3) High performing building design in *Parramatta LEP 2023* for building uses subject to the clause.

The NABERS equivalent energy and water targets in subclause 7.25 (3) High performing building design in *Parramatta LEP 2023* are:

Column 1 (building use)	Column 2 (Energy Target):	Column 3 (Water Target)
Retail premises	<p><u>LEP requirement as per Cl. 7.25(4)</u> < 52.8 kgCO₂/m²/annum</p> <p><u>NABERS equivalent:</u> 4.5 star Energy Rating (Shopping Centre rating*).</p>	<p><u>LEP requirement as per Cl. 7.25(4):</u> < 1.1 kl/m²/annum</p> <p><u>NABERS equivalent:</u> 3.5 star Water Rating (whole building*).</p>
Office premises	<p><u>LEP requirement as per Cl. 7.25(4):</u></p>	<p><u>LEP requirement as per Cl. 7.25(4):</u></p>

	<p>< 63.8 kgCO₂/m²/annum</p> <p>NABERS equivalent:</p> <p>5.5 star Energy Rating (base building*).</p>	<p>< 0.5 kl/m²/annum</p> <p>NABERS equivalent:</p> <p>4.5 star Water Rating (whole building*).</p>
Hotel or motel accommodation or serviced apartments	<p>LEP requirement as per Cl. 7.25(4):</p> <p>< 5,220 kgCO₂/guest room/annum</p> <p>NABERS equivalent:</p> <p>4.5 star Energy Rating (whole building*).</p>	<p>LEP requirement as per Cl. 7.25(4):</p> <p>< 76.1 kl/guest room/annum</p> <p>NABERS equivalent:</p> <p>4.5 star Water Rating (whole building*).</p>
<p>Note – *Denotes the Federal Government’s National Australian Built Environment Rating System (NABERS) terminology regarding ratings scope. Applicants should refer to NABERS for further information.</p>		

Objectives

O.01 Encourage high performing building design (namely the built form, layout and services) of office premises, large-scale retail premises, hotel or motel accommodation, serviced apartments, residential flat buildings and mixed-use development that minimises the consumption of energy and water.

Controls

C.01 Verification of the LEP High Performing Building requirements (4) must be evidenced by a National Australian Built Environment Rating System (NABERS) Commitment Agreement(s) for the development at the necessary level of performance. The part of any building used for the purposes in Column 1 of the control table, does not exceed the energy emission in Column 2 of the control table and the water usage in Column 3 of the control table:

Column 1 (Building use)	Column 2 (Energy Target)	Column 3 (Water Target)
Retail premises	4.5 star NABERS Energy Rating (Shopping Centre rating*).	3.5 star NABERS Water Rating (whole building*).
Office premises	5.5 star NABERS Energy Rating (base building*).	4.5 star NABERS Water Rating (whole building*).
Hotel or motel accommodation or serviced apartments	4.5 star NABERS Energy Rating (whole building*).	4.5 star NABERS Water Rating (whole building*).

Notes –

- *Denotes the Federal Government’s National Australian Built Environment Rating System (NABERS) terminology regarding ratings scope. Applicants should refer to NABERS for further information.
- The energy and water requirements in Columns 2 and 3 were extracted from the Federal Government’s National Australian Built Environment Rating System (NABERS) registry on 26 February 2020 and represent the 15th percentile of best performance of similar existing buildings of

a similar usage type in the Sydney metropolitan region. These requirements will be regularly reviewed by Council to ensure high performing building measures improve over time to reflect new technologies and commercial viability. The first review is anticipated to be in response to the new Sustainable Buildings SEPP incorporating BASIX that will come into force on 1 October 2023.

- C.02 A report prepared by a qualified consultant to the satisfaction of the Council must be submitted with the DA that verifies:
- a) the necessary annual emissions intensity and water performance targets to meet the requirements in C.01 under at the time of application have been established and confirmed, and
 - b) the building will meet the annual energy and annual water performance targets established in C.01, has adequate allowance (including budget) in the design of the building and its services to meet these targets, and is committed to a post occupancy verification against the targets.
- C.03 The report requirements specified in C.02 for energy must be verified through the provision of a signed National Australian Built Environment Rating System (NABERS) Commitment Agreement.

9.8.2 DUAL WATER SYSTEMS

Objectives

- O.01 Increase resilience and water security by providing an alternative water supply to buildings.
- O.02 Reduce the technical and financial barriers to upgrading buildings to connect to future non-drinking water supply infrastructure.
- O.03 Support the growth infrastructure requirements for the Greater Parramatta Olympic Peninsula.

Controls

- C.01 All development involving the construction of a new building or significant alterations to an existing building must install a dual water or reticulation system to support the immediate or future connection to a recycled water network. The design of the dual reticulation system is to be such that a future change-over to an alternative water supply can be achieved without significant civil or building work, disruption or cost.
- C.02 To facilitate this, the dual reticulation system is to have:
- a) One reticulation system servicing drinking water uses, connected to the drinking water supply, and
 - b) One reticulation system servicing all non-drinking water uses, such as toilet flushing, irrigation and washing machines. The non-drinking water system is to be connected to the rainwater tank with drinking water supply backup, until an alternative water supply connection is available. The non-drinking system is to be provided with a connection point adjacent the street boundary for easy connection to a future district non-drinking water supply.

- c) Metering of water services is to be in accordance with the Sydney Water [Multi-level individual metering guide, Version 10, March 2022](#). Individual metering of the non-drinking water service is optional.

9.8.3 ALL ELECTRIC BUILDINGS

Buildings built today will be around for the next 50-100 years. Moving away from buildings that use on-site combustion of fossil fuels to power appliances is a key strategy for buildings to reduce emissions from the increasingly renewable grid supplied electricity, and transition to a low carbon future. All electric buildings also reduce construction and operating costs through the elimination of gas pipes and metering and ongoing connection and usage charges, as well as providing enduring health benefits to occupants.

Objectives

- O.01 Reduce the combustion of fossil fuels through electric only connected new buildings, that benefit from the progressive greening of grid supplied electricity in NSW.
- O.02 Reduce indoor air pollutants associated with the onsite combustion of gas to improve airquality for occupants.
- O.03 Operational cost savings to occupants through the avoidance of gas connection and ongoing connection charges.
- O.04 Reduction in need for utility cabinets in the street and on street walls.

Controls

- C.01 All new buildings are to use only electricity (grid provided and on-site renewables) for all energy requirements associated with normal operations.
- C.02 Where it is demonstrated that the intended use of the building requires a process or equipment that is not able to be served by electricity, fossil fuels may be provided to servicethat service only. Evidence shall be provided with the application of market testing and equipment supplier advice to confirm that an electricity powered alternative is not technically possible.

9.8.4 ELECTRIC VEHICLE CHARGING INFRASTRUCTURE

The transition to electric vehicles and the phasing out of fossil fuel use are key strategies to reduce emissions and move to a low carbon future. The following controls aim to provide the essential infrastructure for vehicle charging that will future proof the buildings and ensure residents can easily transition to electric vehicles. Without essential infrastructure, the future installation of charging facilities by an apartment owner can be much more expensive and, in some cases, technically impossible.

The requirements for electric vehicle parking spaces in this section are to be included within the total maximum number of parking spaces required by Clauses 7.17, 7.18 and 7.19 in *Parramatta LEP 2023*.

Objectives

- O.01 Realise the positive benefits of increased electric vehicle adoption on urban amenity including air quality and urban heat.
- O.02 Ensure new development in Parramatta provides the necessary infrastructure to support the charging of electric vehicles.
- O.03 Minimise the impact of electric vehicle charging on peak electrical demand requirements.

Controls

- C.01 All multi-unit residential car parking must:
 - a) Provide an EV Ready Connection to at least one car space for each dwelling.
 - b) Provide EV Distribution Board(s) in of sufficient size to allow connection of all EV Ready Connections and Shared EV connections.
 - c) Locate EV Distribution board(s) so that no future EV Ready Connection will require a cable of more than 50 metres from the parking bay to connect.
 - d) Identify on the plans submitted with the DA the future installation location of the cable trays from the EV Distribution Board to the car spaces allocated to each dwelling that are provided a Future EV connection, with confirmation of adequacy from an electrical engineer. Spatial allowances are to be made for cables trays and EV Distribution Board(s) when designing in other services.
- C.02 All car share spaces and spaces allocated to visitors must have a Shared EV connection.
- C.03 All commercial building car parking must provide 1 Shared EV connection for every 10 commercial car spaces distributed throughout the carpark to provide equitable access across floors and floor plates.

Glossary

The following Electric Vehicle (EV) technical terms are used:

EV Ready Connection is the provision of a cable tray and a dedicated spare 32A circuit provided in an *EV Distribution Board* to enable easy future installation of cabling from an EV charger to the *EV Distribution Board* and a circuit breaker to feed the circuit.

Shared EV Connection is the provision of a minimum Level 2 40A fast charger and Power Supply to a car parking space connected to an *EV Distribution Board*.

EV Distribution Board is a distribution board dedicated to EV charging that is capable of supplying not less than 50% of EV connections at full power at any one time during off-peak periods. This will ensure that the impacts of maximum demand are minimised, and that increases to electrical feed sizes are not required. To deliver this, the distribution board will be complete with an *EV Load Management System* and an active suitably sized connection to the main switchboard. The distribution board must provide adequate space for the future installation (post construction) of compact meters in or adjacent to the distribution board, to enable the body corporate to measure individual EV usage in the future.

EV Load Management System is a system capable of:

1. Reading real time current and energy from the electric vehicle chargers under management
2. Determining, based on known installation parameters and real time data, the appropriate behaviour of each EV charger to minimise building peak power demand whilst ensuring electric vehicles connected are full recharged.
3. Scale to include additional chargers as they are added to the site over time.

9.8.5 URBAN COOLING

Urban heat or the Urban Heat Island effect refers to the higher temperatures experienced in urban areas compared to rural or natural areas. Urban heat impacts our communities, businesses and natural environment in many ways, including increase demand for electricity and water, a less comfortable public domain for pedestrians and associated health impacts. On average, Parramatta experiences more frequent hotter days than Sydney average (Australian Bureau of Meteorology).

As more development occurs across the City, the build-up of heat in the environment occurs through trapping of radiation in street canyons, increased hard surfaces, reduced vegetation, and heat rejection from buildings surfaces and air conditioning units. The build-up of heat is compounded as more dense urban environments reduce the amount of heat able to be removed by wind and re-radiation to the night sky, extending the period of discomfort.

This section provides controls which aim to cool and remove heat from the urban environment at the city and local scale. These are innovative controls based on Australian and international evidence on cities and the urban heat island effect. The controls address the:

- Reflectivity of building roofs, podiums and facades;
- Reduce the impacts of heat rejection sources of heating and cooling systems; and

- Green roofs or walls.

The following complementary controls assist with the reduction of urban heat:

- Encouraging laminar wind flows and reducing turbulence through the Setbacks above Street and Lane Frontage height controls Section 9.3.3 – The Building Envelope).
- Vegetation and retention of soil moisture through Water Sensitive Urban Design (Section 5.1.2 – – Water Sensitive Urban Design);
- Street trees and vegetation in the public domain (Section 9.4.2.2 – Street Trees Have Priority);
- Well-designed Landscaping and Green Roofs and Walls (Sections 9.6.8.6.4– Green Roofs or Walls); and
- Awnings on streets (Section 9.4.2 – Awnings and Trees on Streets).

Solar heat reflectivity should not be confused with solar light reflectivity, as these are distinctly different issues. Solar heat contributes to urban warming and solar light reflectivity can be the cause of glare, which is covered in Section 9.8.6 – Solar Light Reflectivity.

These controls do not consider energy efficiency or thermal comfort within buildings. These important issues are dealt with in other controls, State Environmental Planning Policies and the National Construction Code.

The following technical terms are used as part of controls in this section:

Solar Reflectance Index (SRI) is a composite measure of a materials ability to reflect solar radiation (solar reflectance) and emit heat which has been absorbed by the material. For example, standard black paint has a SRI value of 5 and a standard white paint has a SRI value of 100.

Reflective Surface Ratio (RSR) is the ratio of reflective to non-reflective external surface on any given façade.

Reflective surfaces are those surfaces that directly reflect light and heat and for the purposes of this DCP are defined as those surfaces that have specular normal reflection of greater than 5% and includes, but is not limited to, glazing, glass faced spandrel panel, some metal finishes and high gloss finishes.

Note – For calculation in Table 9.8.5.2.1 and Table 9.9.8.5.2.2, RSR is to be expressed as a percentage between 1 and 100.

Non-reflective surfaces are those surfaces that diffusely reflect light and heat and for the purposes of this DCP are defined as those surfaces that have specular normal reflection of less than 5%.

Maximum External Solar Reflectance is the maximum allowable percentage of solar reflectance for the external face of a Reflective Surface. The percentage of solar reflectance is to be measured at a normal angle of incidence.

Objectives

- O.01 Reduce the contribution of development to urban heat in the City.
- O.02 Improve user comfort in the local urban environment (communal/private open space and the public domain).

9.8.5.1 ROOF SURFACES

Objectives

- O.01 Reflect and dissipate heat from roofs and podium top areas.
- O.02 Improve user comfort of roof and podium top areas.

Controls

- C.01 Where surfaces on roof tops or podiums are used for communal open space or other active purposes, the development must demonstrate at least 50% of the accessible roof area complies with one or a combination of the following:
 - a) Be shaded by a shade structure;
 - b) Be covered by vegetation consistent with the controls under Section 9.8.5.4 – Green Roofs or Walls;
 - c) Provide shading through canopy tree planting, to be measured on extent of canopy cover 2 years after planting.
- C.02 Where surfaces on roof tops or podiums are not used for the purposes of private or public open space, for solar panels or for heat rejection plant, the development must demonstrate the following:
 - a) Materials used have a minimum solar reflectivity index (SRI) of 82 if a horizontal surface or a minimum SRI of 39 for sloped surface greater than 15 degrees; or
 - b) 75% of the total roof or podium surface be covered by vegetation; or
 - c) A combination of (a) and (b) for the total roof surface.

9.8.5.2 FACADES

Objectives

- O.01 Minimise the reflection of solar heat downward from the building façade into communal/private openspace or the public domain.

Controls

- C.01 The facades must demonstrate a minimum percentage of shading calculated on the 21 December and evidenced with the provision of shadow diagrams with the development application. The time and extent of shading required for each façade orientation is detailed in the Technical Requirements UHI façade shading.
- C.02 Shading may be provided by:
 - a) External feature shading with non-reflective surfaces;
 - b) Intrinsic features of the building form such as reveals and returns; and

- c) Shading from vegetation such as green walls that is consistent with the controls in Section 9.4.4 – The Street Wall and Section 9.8.5.4 – Green Roofs or Walls.
- C.03 Where multiple reflective surfaces or concave geometry of reflective surface introduce the risk of focusing of solar reflections into the public spaces:
- Solar heat reflections from any part of a building must not exceed 1,000W/m² in the public domain at any time.
 - A reflectivity modelling report may be required to qualify extent of reflected solar heat radiation. The modelling is required to consider all aspects that influence the amount of solar heat reflected at any point in time, including three-dimensional geometry, façade articulation specularity and angular dependent reflectivity of surfaces.
- C.04 The technical requirements in Section 9.8.5.2.1 below are to be complied with, where applicable.

9.8.5.2.1 TECHNICAL REQUIREMENTS - UHI FAÇADE SHADING

Unshaded facades reflect solar heat into streets and open space where it can be absorbed and contribute to the energy imbalance that causes the urban heat island effect. Modern glass often achieves energy efficiency by maximizing the amount of non-visible heat that is reflected from the glass, which reduces energy into the building but magnifies the amount of heat that is reflected into streets and open space.

All glass and similar reflective materials also increase reflectivity of light and heat and low angles of incidence. It is these low angles of incidence where solar shading is most effective. Figure 9.8.5.2.1 below shows the amount of solar heat that 50% of solar heat would typically be reflected from best case untreated clear glass at a 10° angle of incidence without shading. Solar shading (right) performs well to reduce the amount of solar radiation that will be reflected into the streets and open space as it blocks both the sun from hitting the façade and solar reflections from the façade.

The following technical requirements provides the details for demonstrating the minimum required shading at control C.01 in Section 9.8.5.2 – Facades. The detailed technical requirements are provided to allow non-prescriptive design solutions to meet the minimum shading requirements for façade orientation and extent of reflective surfaces and provide a simple means of confirming adequacy at the time of application.

Facades requiring shading

Facades with reflective surfaces must demonstrate a minimum percentage shading as determined in Tables 9.8.5.2.1 and 9.8.5.2.2 for the 21 December, at the reference times included in Table 9.8.5.2.3.

Shading is not required on facades:

- where the Reflective Surface Ratio (RSR) is less than 30%
- that are orientated south of south-southeast and south-southwest.

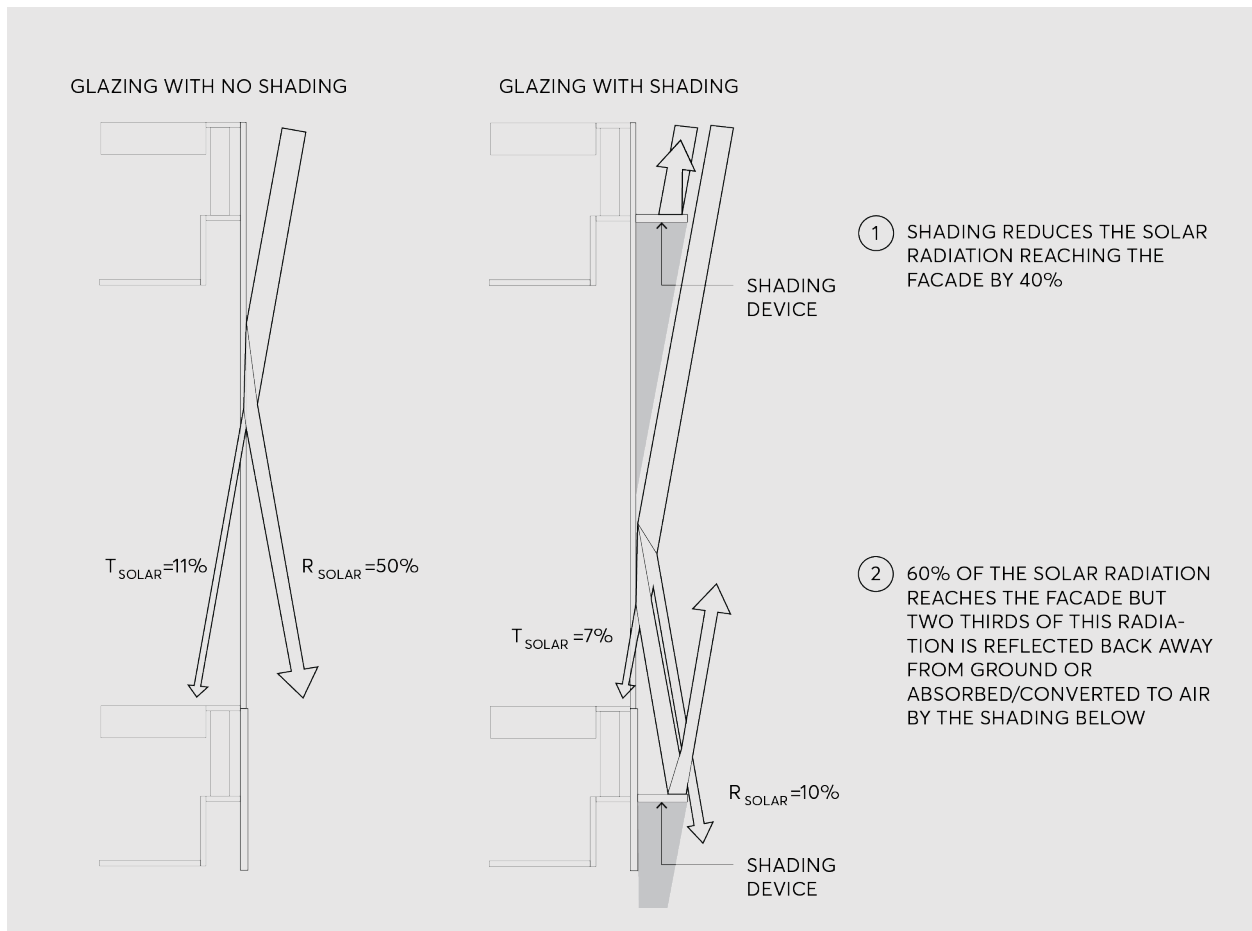

Figure 9.8.5.2.1 – Confirms the shading requirements for each facade orientation.

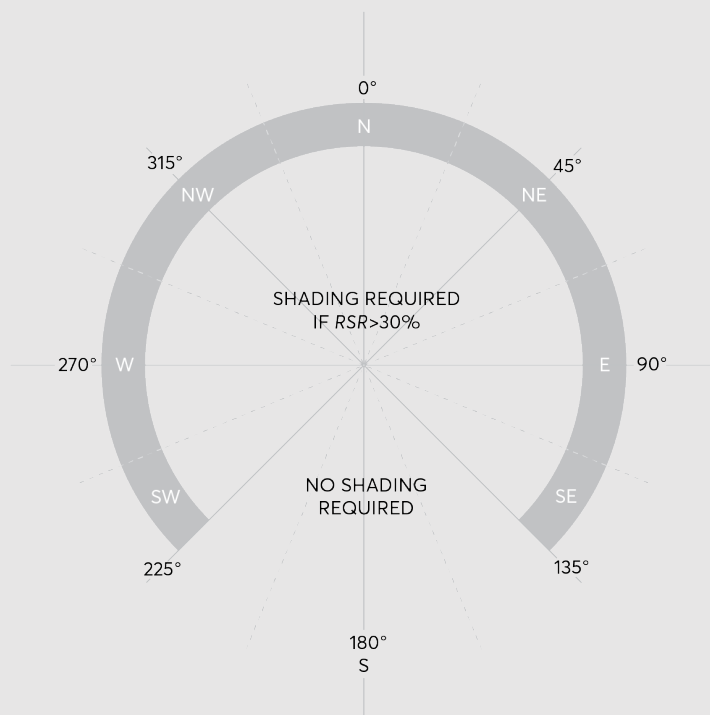

Figure 9.8.5.2.2 – Shading requirements - RSR

Elements which can be counted to shading the facade may be:

- External feature shading with non-reflective surfaces.
- Intrinsic features of the building form such as reveals and returns.
- Shading from vegetation such as green walls that are consistent with the controls on green roofs and walls.

The following elements cannot be counted as shading to the shading requirements:

- Existing buildings; and
- Existing structures.

Percentage of shading required

The percentage shading required to the Reflective surfaces to be shown in the shadow diagram is determined by the Reflective Surface Ratio (RSR) of each façade and the calculation tables below.

Reflective surfaces on street walls (or if no street wall, as measured from the first 21 metres from the ground plane) are to be provided with the minimum percentage shading in Table 9.8.5.2.1.

Reflective Surface Ratio (RSR)	<30%	30% - 70%	≥70%
Minimum Percentage Shading (%)	0	(1.5xRSR)-45	75

Table 9.8.5.2.1 – Calculation of minimum percentage shading for *Reflective surfaces* on street walls

Reflective surfaces on tower façades (above the street wall or if no street wall, as measured above the first 21 metres from the ground plane) are to be provided with the minimum percentage shading in Table 9.8.5.2.2.

Reflective Surface Ratio (RSR)	<30%	30% - 70%	≥70%
Minimum Percentage Shading (%)	0	(0.8xRSR)-24	40

Table 9.8.5.2.2 – Calculation of minimum percentage shading for *Reflective surfaces* on tower facades

Shadow diagram requirements

Shadow diagrams must be submitted with the development application showing the extent of shading of *Reflective surfaces* at the nominated time for each relevant façade.

The shadow diagrams are to include a calculation of the percentage of shading provided and the RSR for each façade.

Table 9.8.5.2.3 provides the nominated sun angles and shadow diagram reference times for each façade orientation where shadow diagrams are required.

Orientation of façade	Time	Sun angles
East ± 22.5°	10:00 AEDT	Sun elevation: 51° Sun Azimuth: 86°
Northeast/Southeast ± 22.5°	11:30 AEDT	Sun elevation: 69° Sun Azimuth: 66°
North ± 22.5°	13:00 AEDT	Sun elevation: 80° Sun Azimuth: 352°
Northwest/Southwest ± 22.5°	14:30 AEDT	Sun elevation: 67° Sun Azimuth: 290°
West ± 22.5°	16:00 AEDT	Sun elevation: 48° Sun Azimuth: 272°

Table 9.8.5.2.3 – Shading sun angles

Where it is demonstrated that shading cannot be achieved in accordance with the shading controls, a Maximum External Solar Reflectance as defined in Table 9.8.5.2.4 is generally acceptable.

Reflective Surface Ratio (RSR)	<30%	30% - 70%	≥70%
Maximum External Solar Reflectance (%)	No Max	$62.5 - 0.75 * RSR$	10

Table 9.8.5.2.4 – Calculation of *Maximum External Solar Reflectance*.

9.8.5.3 HEATING AND COOLING SYSTEMS – HEAT REJECTION

Objectives

- O.01 Reduce the impact of heat rejection from heating, ventilation and cooling systems from contributing to the urban heat island effect in the City; and
- O.02 Avoid or minimise the impact of heat rejection from heating, ventilation and cooling systems on user comfort in private/communal open spaces and the public domain.

Controls

- C.01 Residential apartments within a mixed-use development or residential flat building, and non-residential development must incorporate efficient heating, ventilation and cooling systems (HVAC) which reject heat from a centralised source.
- C.02 The location of centralised heat rejection for buildings should be the roof.
- C.03 For residential apartments within a mixed-use development or residential flat building with more than 8 residential storeys, and where it can be demonstrated that a rooftop location is not practical, the centralised heat rejection can be located in dedicated on-floor plant rooms that are sufficiently sized to provide efficient heat rejection and suitably screened to reduce visual and noise impacts.
- C.04 Where the heat rejection source is located on the upper most roof, these must be designed in conjunction with controls in this Section of the DCP relating to Roof Surfaces and the controls under Section 9.8.5.4 – Green Roofs or Walls.
- C.05 Heat rejection units must not be located on a street wall frontage.
- C.06 HVAC heat rejection is not permitted to be located in wintergardens. Refer Section 9.4.8 – Wintergardens for further controls related to Wintergardens.

9.8.5.4 GREEN ROOFS OR WALLS

Objectives

- O.01 Ensure that green roofs or walls are integrated into the design of new development.

- O.02 Encourage well designed landscaping that caters for the needs of residents and workers of a building.
- O.03 Design green walls or roofs to maximise their cooling effects.
- O.04 Ensure green walls and roofs are designed, located and maintained to respond to local climatic conditions and ensure sustained plant growth.

Controls

- C.01 Green roof and wall structures are to be assessed as a part of the structural certification for the building. Structures designed to accommodate green walls should be integrated into the building façade.
- C.02 Waterproofing for green roofs and walls is to be assessed as a part of the waterproofing certification for the building.
- C.03 Where vegetation or trees are proposed on the roof or vertical surfaces of any building, a Landscape Plan must be submitted which demonstrates:
 - a) adequate irrigation and drainage is provided to ensure sustained plant growth and health and safe use of the space;
 - b) appropriate plant selection to suit site conditions, including wind impacts and solar access; and
 - c) adherence to the objectives, design guidelines and standards contained in the NSW Apartment Design Guide for 'Planting on Structures'.
- C.04 Green roofs or walls, where achievable, should use rainwater, stormwater or recycled water for irrigation.
- C.05 Container gardens, where plants are maintained in pots, may be an acceptable alternative, however, should demonstrate that the containers are of significant scale to support high quality vegetation growth for cooling and amenity.
- C.06 Register an instrument of positive covenant to cover proper maintenance and performance of the green roof and walls on terms reasonably acceptable to the Council prior to granting of the Occupancy Certificate.

9.8.6 SOLAR LIGHT REFLECTIVITY (GLARE)

Objectives

- O.01 Ensure that buildings in the Parramatta City Centre appropriately limit solar light reflected to the public domain, communal/private open spaces, occupants of buildings, road users, and transportation operators.
- O.02 Ensure reflected light minimises discomfort glare.
- O.03 Ensure reflected light does not result in disability glare.

Controls

- C.01 New buildings or significant alterations to existing facades must not result in solar light reflectivity that:
- Results in disability glare that is hazardous for road users and drivers of public transport.
 - Causes discomfort for pedestrians, occupants of other buildings or users of private/communal open spaces and public spaces.
- C.02 Subject to the extent and nature of glazing and reflective materials used, a Reflectivity Report that analyses potential solar light reflectivity and resulting glare from the proposed development on pedestrians, motorists, or surrounding areas may be required.
- C.03 Notwithstanding control C.02 above, new buildings, or significant alterations to existing facades, greater than 40 metres in height require a Reflectivity Report that includes the quantification of solar light reflected from the building on the surrounding environment. Reflectivity reports are to include:
- Sufficiently detailed calculations to quantify likely sources of disability and discomfort glare.
 - Where reflective surfaces are sloped or irregular/undulating, a 3D model should be used to model solar reflections.
 - All calculations are to be based on a published method.
 - Observer points tested should be sufficient to address all potential risks of disability glare and solar light reflections that might cause discomfort.
 - All calculations are to consider the angular dependant solar light reflectivity of the proposed finishes.
 - All calculations are to consider the full range of sun angles that may result in solar light reflections at receiver points and not include obstruction by vegetation outside the subject development or potential mitigation strategies of observers (sun visors, caps, etc).
 - Where solar light reflections from the development exceed thresholds of disability glare and discomfort for any point of observation detailed analysis must be undertaken to determine the range or sun angles or times of day and year that thresholds are exceeded.
- C.04 Generally, specular solar light reflectivity from building materials used on facades must not exceed 20% at the angle of incidence. This requirement does not ensure compliance with the requirements of control C.01 above.

9.8.7 NATURAL REFRIGERANTS IN AIR CONDITIONING

Synthetic refrigerant gases commonly used in air conditioning systems have a very high Global Warming Potential (GWP). The GWP is the number of times the refrigerant is more harmful to the atmosphere than carbon. The best practice synthetic refrigerant available (R32) has a 675 GWP, meaning it's 675 times more harmful than carbon. Natural refrigerants generally have a much lower GWP, typically 2.3, meaning that it is 2.3 times more harmful than carbon.

Leakage from air conditioning systems or the improper disposal of refrigerant can be a significant source of greenhouse gas emissions. Using natural refrigerants with low GWP will reduce the impact of the emissions from air conditioning systems.

These impacts are recognised under the Montreal Protocol, which from 2016 commenced the global phase-down of Hydrofluorocarbons (HFCs), the most common type of synthetic refrigerant.

Objectives

- O.01 Reduce the greenhouse gas emissions associated with the release to the atmosphere through leakage or the improper disposal, of synthetic refrigerant gases with high Global Warming Potential (GWP).
- O.02 Future proof new HVAC (air conditioning) systems from the global phase-down of Hydrofluorocarbon (HFC) under the Montreal Protocol.

Controls

- C.01 All new air-conditioning and refrigeration equipment are to use refrigerants with a GWP of less than 10;
 - a) if the equipment can be supplied on similar terms to conventional systems, and
 - b) at a cost of not more than 10% higher than the market rate for conventional systems.

9.8.8 BIRD FRIENDLY DESIGN

Glass buildings are an increasing source of bird collisions resulting in significant numbers of mortalities and injuries. The primary cause of collisions is transparency and reflectivity associated with the high levels of glazing.

Birds, unlike humans, cannot perceive the external glazing and fly into it attempting to travel to the reflected view of open sky vegetation or parklands; potential perches, food or water sources; or other attractors. Incidents increase in times of drought as higher numbers of birds enter urban areas to forage. Nocturnal birds also fly into external glazing as they are attracted to internal lighting.

Documented bird fatalities from building collisions in the Sydney region include the critically endangered Swift Parrot, vulnerable Powerful Owl and White-Bellied Sea Eagle. The World Wildlife Fund (WWF) produced guidelines and recommendations for 'Swift Parrot-Safe Building Design' with support of the Australian Government in 2008.

Treatment and design of glazed facades to minimise bird strike will make an important contribution to the protection of endangered and migratory birds and also protect the urban native bird population.

Objectives

- O.01 Minimise the risk of bird collisions due to high transparency, through treatment of external windows and other glazed building surfaces.

- O.02 Require additional treatment, or reduced reflectivity and transparency of external windows and other glazed building surfaces, where buildings are located within 100 metres of specified waterways and parklands.

Controls

- C.01 Treatment of all external windows and other glazed building surfaces of buildings is required to any new glazed surface (whether part of a new building or a building undergoing alterations and additions), when the glazed surface is:
- a) Less than 6 metres from another glazed surface such as corners and skybridges.
 - b) Less than 6 metres from an internal planted area such as a green wall or planted atrium.
 - c) Projecting vertically more than 1 metre above the building roof line.
 - d) Projecting horizontally more than 1 metre beyond the building enclosed façade.
- C.02 Where buildings are located within 100 metres of the Parramatta River corridor, Parramatta Park, Prince Alfred Park, Robin Thomas Reserve, James Ruse Reserve, Experiment Farm, Jubilee Park and Ollie Webb Reserve, treatment to 95% of glazing is required.
- C.03 Treatment to the glazing must be either:
- a) Bird strike UV patterning such as Ornilux.
 - b) Fritted, etched, channelled or translucent glass such as Silk-screen with a minimum untreated dimension of 100mm x 100mm.
 - c) External treatments such as angled, layers or recessed glazing, shading elements such as louvers, overhangs and awnings or mesh with a minimum open dimension of 100mm x 100mm.

9.8.9 WIND MITIGATION

Objectives

- O.01 Ensure that the building form enables the provision of a safe and comfortable pedestrian level wind environment, including street frontages, outdoor eating areas, open spaces.
- O.02 To provide publicly accessible terrace areas within developments, as well as private communal terrace areas, and private balconies within developments.
- O.03 To ensure wind conditions promote outdoor planting, including green roofs and other landscaping elements.

Controls

- C.01 To ensure comfort in and around new buildings, the wind speeds in Table 9.8.9.1 below must be exceeded for less than 5% of the time around new buildings for both hourly mean and gust equivalent mean wind speeds:

< 2 m/s	Outdoor restaurant dining
< 4 m/s	Sitting (such as café style dining), or scheduled outdoor events
< 6 m/s	Standing, generally supports outdoor planting
< 8 m/s	Walking in retail areas / active street frontages?
< 10 m/s	Walking / non-active street frontages (objective walking from A to B or for cycling)

Table 9.8.9.1 – Wind speeds

- C.02 To ensure public safety, a 3 second moving average gust wind speed of 23 metres/second must be exceeded for less than 0.1% of time.
- C.03 A wind study report must be submitted with the DA for all buildings greater than 20 metres in height.
- C.04 For buildings greater than 40 metres in height, or sites with more than one building greater than 20 metres in height, the quantitative results from a wind tunnel test are to be included in the wind study report.
- C.05 The wind study is to be conducted by an experienced professional wind engineer in accordance with the requirements outlined in the Technical Requirements – Wind Mitigation Performance Methodology in Section 9.8.9.1.
- C.06 The technical requirements in Section 9.8.9.1 below must be met, where applicable.

9.8.9.2 TECHNICAL REQUIREMENTS – WIND MITIGATION PERFORMANCE METHODOLOGY

These technical requirements are based on: *CCP Wind Assessment for: City of Parramatta November 2016 CCP Project 9776*.

Expertise

A wind study shall be performed by a professional wind engineer with experience in wind issues in the built environment.

The applicant or the wind engineer is to consult the City of Parramatta's Planning Department prior to lodging the development application to agree on the type and approach of the wind study required for the proposed development.

Wind data

Historical data of wind speed and direction collected over a minimum of 10 years shall be used as the basis of a pedestrian level wind study. Data from the Bankstown Airport Bureau of Meteorology anemometer starting earliest in 1993 shall be used and adequately corrected for the effects of differences in roughness of the surrounding natural and built environment. The use of wind data for daytime hours between 6am and 9pm is generally recommended and may be specifically requested by the City of Parramatta, however, wind data for all hours may be used as well, where appropriate. Climate data are to be presented in the wind study report.

Criteria

The criteria for pedestrian level wind comfort are based on published research, particularly on the criteria developed Lawson in *The Determination of the wind environment of a building complex before construction*, Department of Aerospace Engineering, University of Bristol, Report Number. Pedestrian safety is affected by both the mean and the gust wind speed.

The criteria in Table 9.8.9.2 below are to be applied to both the mean wind speed and the Gust Equivalent Mean (GEM), i.e. the 3 s gust wind speed in an hour divided by 1.85.

Comfort (maximum of mean and gust equivalent mean (GEM*) wind speed exceeded 5% of the time)	
< 2 m/s	Outdoor restaurant dining
2-4 m/s	Sitting (such as café style dining), or scheduled outdoor events
4-6 m/s	Standing, generally supports outdoor planting
6-8 m/s	Walking in retail areas / active street frontages
8 - 10 m/s	Walking / non-active street frontages (objective walking from A to B or for cycling)
> 10 m/s	Uncomfortable
Distress (maximum of mean or GEM wind speed exceeded 0.022% of the time)	

Table 9.8.9.2 – Mean wind speed

Note – *The gust equivalent mean (GEM) is the peak 3 s gust wind speed divided by 1.85.

The criterion in Table 9.8.9.3 below for pedestrian safety is based on the *Guidelines of the Australian Wind Engineering Society* (2014).

Safety (maximum 3s moving average gust wind speed)	
<23m/s	not to be exceeded more than 0.1% of time per year

Table 9.8.9.3 – Pedestrian safety criteria

The wind study report shall show that the proposed development provides for adequate levels of comfort and safety in accordance with the above criteria taking into account the intended usage of a particular area. If the above criteria are not met, appropriate mitigation measures shall be identified, or the proposed building design is to be altered. Further, the existing wind conditions shall not be significantly degraded by a proposed development over the assessment area.

Mitigation Measures

If the wind study identifies areas that do not fulfil the comfort or safety criteria, mitigation strategies are to be developed and their effectiveness in improving the wind conditions to the required level is to be shown and tested in the wind tunnel. These measures may include, in order of preference:

- a) Changes to the building massing or design including the addition or extension of podiums, tower setbacks, or
- b) Addition of canopies or wind screens.

On-site vegetation may be used to improve the wind comfort for pedestrians, however, it is not an acceptable mitigation for exceedances of the safety criterion. To be accepted as a mitigation for wind comfort issues, the plants need to be effective at the time of installation and need to be able to provide improvement throughout the year.

Furthermore, the plants shall require minimum maintenance and are to be able to thrive in the wind conditions of the site.

- a) The plants must be within the site boundary and not on public land.
- b) Modifications of the usage of affected areas and provision of alternatives.

Type of Wind Study

Qualitative Wind Study

A qualitative wind study is generally required for developments with a building exceeding a height of 20 metres above finished ground and less than 40 metres above finished ground (and may be requested by the City of Parramatta Council on a case by case basis for smaller developments). A qualitative wind assessment can be performed as a desktop study, or by Computational Fluid Dynamics (CFD).

A desktop study shall estimate the wind speeds at relevant locations in and around the proposed development taking into consideration the wind comfort and safety criteria described in the DCP Controls. The assessment is to be based on all prevailing wind directions and shall account for the frequency of occurrence.

CFD simulations shall appropriately represent the atmospheric boundary layer and model appropriate parts of the natural and built environment surrounding the proposed development. The study is to consider all prevailing wind directions as well as the frequency of occurrence.

Presentation of the results shall include horizontal planes at pedestrian level of approximately 1.5 metres, horizontal and vertical planes are required for outdoor planting, and details of the computational mesh and consistency of the wind conditions across the modelled domain.

Quantitative Wind Study

A quantitative wind study shall be performed in a boundary layer wind tunnel capable of simulating the atmospheric boundary layer and appropriate profiles. A quantitative study is required for developments with a building exceeding a height of 40 metres above ground and developments with more than 1 building exceeding 20 metres in height.

Physical modelling of the proposed development shall be done at an adequate scale, typically 1:300 or 1:400, and appropriate levels of surrounding natural and built environment of at least a 400 metres radius around the proposed development site shall be taken into account.

Wind speed measurements shall be performed in accordance with the Australasian *Wind Engineering Society's Quality Assurance Manual (QAM) for Wind Engineering Studies of Buildings* (AWES, 2001):

- a) Measurements shall be taken with instruments capable of measuring wind characteristics at adequate resolution, e.g. hot-wire or hot-film anemometers, Irwin probes.
- b) Measurements for pedestrians shall be taken at the equivalent full scale height of approximately 1.5 metres.
- c) Measurements for outdoor planting shall be taken to suit the proposed design
- d) Measurements shall be taken at a minimum of 1 location per 200 metres squared of the plan area accessible for pedestrians or to be planted, and the selection of locations shall take into account the intended use of the space.
- e) The assessment area shall include the public and private outdoor areas to a minimum distance of D from the building envelope, with D being the lesser of half the building height or half the largest plan dimension of the building.
- f) Measurements shall be taken for at least 16 wind directions.

Configurations

To be able to compare the wind environment with the inclusion of the proposed development, measurements at representative locations are to be conducted in the existing configuration without the proposed development. This configuration shall include all existing surrounds, as well as developments that are approved or under construction. These surrounds shall also be applied in the proposed configuration. In specific circumstances Council may require additional testing of a future configuration to include future developments that may impact the wind conditions around the proposed development, e.g. developments currently in the approval process.

9.9 VEHICULAR ACCESS, PARKING AND SERVICING

9.9.1 VEHICLE DRIVEWAYS AND MANOEUVRING

This section should be read in conjunction with the controls for Vehicle Footpath Crossing contained in Section 9.4.6 – Vehicle Footpath Crossings of the Public Domain.

Objectives

- O.01 Minimise the impact of vehicle access points and driveway crossovers on streetscape amenity, pedestrian safety and the quality of the public domain by:
- Designing vehicle access to required safety and traffic management standards.
 - Integrating vehicle access with site planning, public domain requirements and traffic patterns.
 - Minimising potential conflict with pedestrians.
- O.02 Minimise the size and quantity of vehicle and service crossings to reinforce a high-quality public domain.

Controls

- C.01 Where practicable, driveways must be provided from lanes and secondary streets rather than primary street fronts or streets with major pedestrian activity.
- C.02 Driveways must be located:
- Taking into account any services within the road reserve, such as power poles, drainage inlet pipes and existing or proposed street trees.
 - A minimum of 10 metres from the perpendicular of any intersection of any two streets.
 - If adjacent to a residential development, set back a minimum of 2 metres from the relevant side property boundary.
- C.03 Design of driveway crossings must be in accordance with the [Parramatta Public Domain Guidelines](#), with any works within the footpath and road reserve subject to a *S138 Roads Act 1993* approval.
- C.04 Driveway widths must comply with the relevant Australian Standards.
- C.05 Vehicle access must be designed to:
- Minimise the visual impact on the street, public domain, site layout and building facade design.
 - Minimise the size, quantity and visual intrusion of the access.
 - Be a minimum of 3 metres from pedestrian entrances.
 - Not be located adjacent to doors or windows of habitable rooms of any residential development.

- C.06 Vehicular access must not ramp along boundary alignments bordering the public domain, streets, lanes, parks, river foreshore frontages or heritage items.
- C.07 All vehicles must be able to enter and leave the site in a forward direction.
- C.08 Separate and clearly differentiate between pedestrian and vehicle access.
- C.09 Car space dimensions must comply with the relevant Australian Standards.
- C.10 Driveway grades, vehicular ramp widths and grades and passing bays and sight distance for driveways must be in accordance with the relevant Australian Standard (AS 2890.1).
- C.11 Vehicular access, egress and manoeuvring requirements for NSW Fire Brigade vehicles must be provided in accordance with relevant NSW Fire Brigade guidelines as far as they apply to the subject development.

9.9.2 ON SITE CAR PARKING

On-site parking includes underground (basement) parking, surface (at-grade) parking and above ground parking. It also includes car parking stations.

Underground and semi-underground parking minimises visual impact of car parking as viewed from the public domain. Above ground parking may be appropriate for some sites, especially for sites constrained due to flood levels or archaeology. Above ground parking will only be accepted if it is of high design quality and meets the design controls specified in Section 9.3 – Built Form.

Car parking rates for developments within the Parramatta City Centre are contained in Division 4 of *Parramatta Local Environment Plan 2023*. These rates are maximums and are not to be exceeded.

This section should be read in conjunction with Part 6 Traffic and Transport of this DCP in relation to car share and green travel plan controls and Section 9.9.3 – Bicycle Parking and End of Journey Facilities.

Car parking facilities require specific design considerations in flood risk areas in addition to the universal considerations that minimise the visual impact of these structures. A safely designed car park restricts flood water entry while providing failsafe opportunities for emergency egress. This section should be read in conjunction with Section 9.7.8 – Car Park Basements in Flood Prone Areas regarding flood risk management particularly for basement car parking.

Objectives

- O.01 Facilitate an appropriate level of on-site parking for development within the Parramatta City Centre to cater for a mix of development types.
- O.02 Minimise the impact of on-site parking on the design quality of the building and the public domain.
- O.03 Provide adequate space for parking and manoeuvring of vehicles, including service vehicles.
- O.04 Recognise the current and existing demand for parking for bicycles and electric vehicles.
- O.05 Design car parking for safe pedestrian and bicycles movements.

Controls

- C.01 Basement car parking must be located within the site boundaries and must not encroach on the public domain.
- C.02 Where car parking is provided in basements and semi basements which involve excavation, development must incorporate the recommended site management procedures set out in the Parramatta Historical Archaeology Landscape Management Study.
- C.03 New access points to all parking (basement or above ground) are to be limited in accordance with Figure 9.4.6.1 (in Section 9.4.6 – Vehicle Footpath Crossings). New access points may be permitted from existing lanes or any new lanes proposed as part of the development.
- C.04 Design car parking which:
- Maximises the efficiency of car park design with predominantly orthogonal geometry and related to circulation and car space size.
 - Is well-lit and minimises reliance on artificial lighting and ventilation.
 - Is well-ventilated and uses natural rather than mechanical ventilation where possible.
 - Provides marked safe path so travel for pedestrians and cyclists with clear lines of sight and safe lighting.
 - Avoids hidden areas and enclosed areas. Where these are unavoidable use mirrors and similar devices to aid surveillance.
- C.05 Provide readily accessible parking spaces at the rates specified under the National Construction Code which are designed and appropriately signed for use by people with disabilities in accordance with AS 2890.6.
- C.06 Provide a separate parking space for 1 motorcycle for every 50 car spaces, or part thereof. The size of a motorcycle parking space is to be in accordance with AS 2890.1. Motorcycle parking does not contribute to the number of car parking spaces permitted.
- C.07 On-site parking must meet the relevant Australian Standards.
- C.08 For residential flat buildings or the residential component of a mixed use development, stack parking of up to 2 cars is permitted where spaces are attached to the same single dwelling unit.
- C.09 To facilitate adaptation of car parking to other uses in the long term, or to promote de-coupled car parking, consideration will be given to car parking remaining as part of the common property and not part of or attached to individual strata units.

9.9.3 BICYCLE PARKING AND END OF JOURNEY FACILITIES

New developments should provide opportunities to support sustainable transport and active lifestyles by providing bicycle parking and end of trip facilities. These provisions provide facilities will help reduce private car use and the environmental impact of transport and promote active streets and community health and wellbeing.

Objectives

- O.01 To provide quality bicycle parking and end of journey facilities to meet the needs of residents, workers of and visitors to the Parramatta City Centre.
- O.02 To ensure bicycle parking and end of journey facilities are convenient, safe for users and minimises conflict between people and vehicles.

9.9.3.2 BICYCLE PARKING

Controls

- C.01 All development is to provide on-site bicycle parking designed in accordance with Australian Standard AS2890.3.
- C.02 Bicycle parking spaces for new development is to be provided in accordance with the rates set out in Table 9.9.3.1:

Proposed use	Residents / Employees Bicycle Parking Spaces*	Visitors*
Residential:		
Residential accommodation	1 per dwelling	1 per 10 dwellings
Commercial:		
Office premises or business premises	1 per 150sqm GFA over 600sqm of GFA	1 per 400sqm GFA
Shop, restaurant or café	1 per 250sqm GFA over 600sqm of GFA	2 for first 600sqm of GFA plus 1 per 100sqm over additional 100sq of GFA
Shopping centre	1 per 200sqm GFA over 600 of GFA	2 for first 600sqm of GFA plus 1 per 300sqm sales GFA
Community:		
Child Care Centre	1 per 10 staff	2 per centre
Library and community centres	1 per 10 staff	2 plus 1 per 200sqm GFA
Education Establishment	1 per 10 FTE staff	1 per 10 FTE students over Year 4- and accommodated securely undercover and within the campus grounds.
Tourist and visitor accommodation:		
Hotel or motel accommodation or serviced apartments	1 per 4 staff	1 per 20 rooms

Note – * the total minimum number of bicycle parking spaces is to be rounded up to the nearest whole number.

Table 9.9.3.1 – On-site bicycle parking rates

- C.03 If proposed use is not included in Table 9.9.3.1, a development is to provide bike facilities to accommodate mode share target for trips by bicycles as described in the [Parramatta Bike Plan](#).
- C.04 Wherever possible, bicycle parking for residents and or employees should be provided at-grade. Where bicycle parking is provided within the basement or above ground levels, it is to

- be located on the first level of basement or first level above ground and in proximity to entry or exit points.
- C.05 The following access to bicycle parking areas are to be provided and designed in accordance with Australian Standard AS2890.3:
- a) Provide for a clear and safe path of travel to minimise conflict between vehicles, pedestrians and cyclists.
 - b) Accessible via a ramp.
 - c) Clearly identified by signage.
 - d) Accessible via appropriate security or intercom systems.
- C.06 The minimum secure bicycle parking facilities are to be provided in accordance with the following Australian Standard AS2890.3:
- a) Class B bicycle lockers for occupants of residential buildings and staff or employees of any non-residential land use.
 - b) Class C bicycle rails for visitors of any land use.
- C.07 Wherever possible, visitor bicycle parking shall be located within the development site, at grade, near entry points to the building, undercover and be accessible at all times. Where visitor bicycle parking cannot be provided at grade it is provided on the first level of basement or first level above ground adjacent to the visitor car parking and be accessible at all times.
- C.08 The area required for bicycle parking is to be calculated in addition to storage areas required as per the NSW Apartment Design Guide.
- C.09 The bicycle storage facility is to include 10A e-bike charging outlets to 10% of spaces with no space being more than 20 metres away from a charging outlet. Chargers are to be provided by the owner.

9.9.3.3 END OF JOURNEY FACILITIES

Controls

- C.01 For non-residential uses end of journey facilities are to be provided at the following rates:
- a) 1 personal locker per bicycle parking space;
 - b) 1 shower and change cubicle for up to 10 bicycle parking spaces;
 - c) 2 shower and change cubicles for 11 to 20 or more bicycle parking spaces are provided; and
 - d) 2 additional shower and cubicles for each additional 20 bicycle parking spaces or part thereof.
- C.02 Shower and change room facilities may be provided in the form of shower and change cubicles in a unisex area.
- C.03 Shower and change room facilities are to be designed to accommodate separate wet and dry areas, including an area to hang towels and clothes.

C.04 End of journey facilities are to be located:

- a) where facilities are provided within the basement or above ground levels, it is to be located on the first level of basement or first level above ground and in proximity to entry or exit points;
- b) provide for a clear and safe path of travel to minimise conflict between vehicles and pedestrians;
- c) in close proximity to bicycle parking facilities and the entry and exit points; and
- d) within an area of security camera surveillance, where there are such building security systems available.

C.05 Development proposing multiple commercial tenancies must demonstrate how all tenancies will have access to the end of journey facilities and employee bicycle parking.

9.10 SITE SPECIFIC CONTROLS

This section contains development controls for specific sites in the City Centre as identified in Figure 9.10.

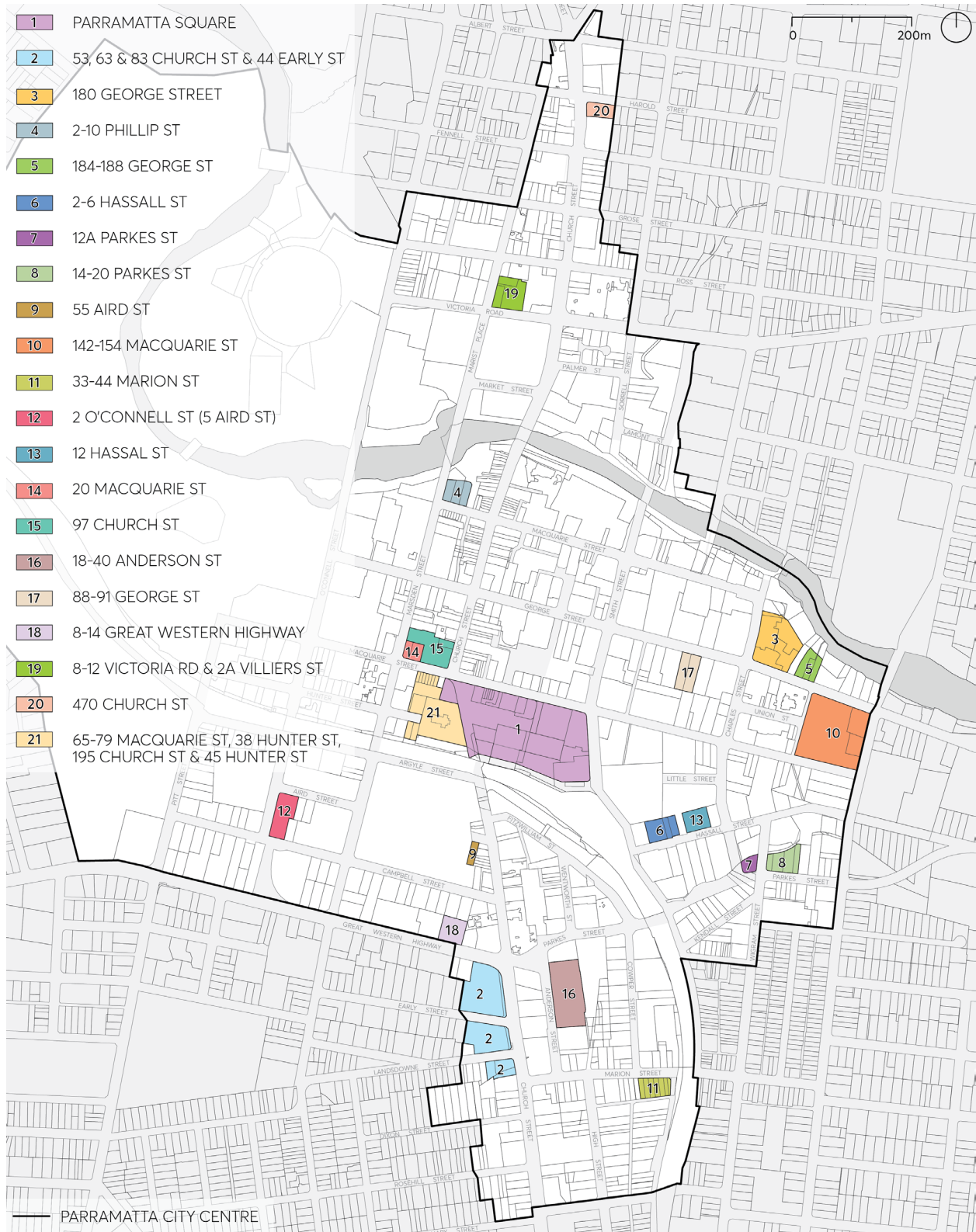

Figure 9.10 – Land parcels with Site Specific Controls

9.10.1 PARRAMATTA SQUARE

This Section applies to Parramatta Square which is bounded by Macquarie, Smith, Darcy and Church Streets, Parramatta as shown in Figure 9.10.1.

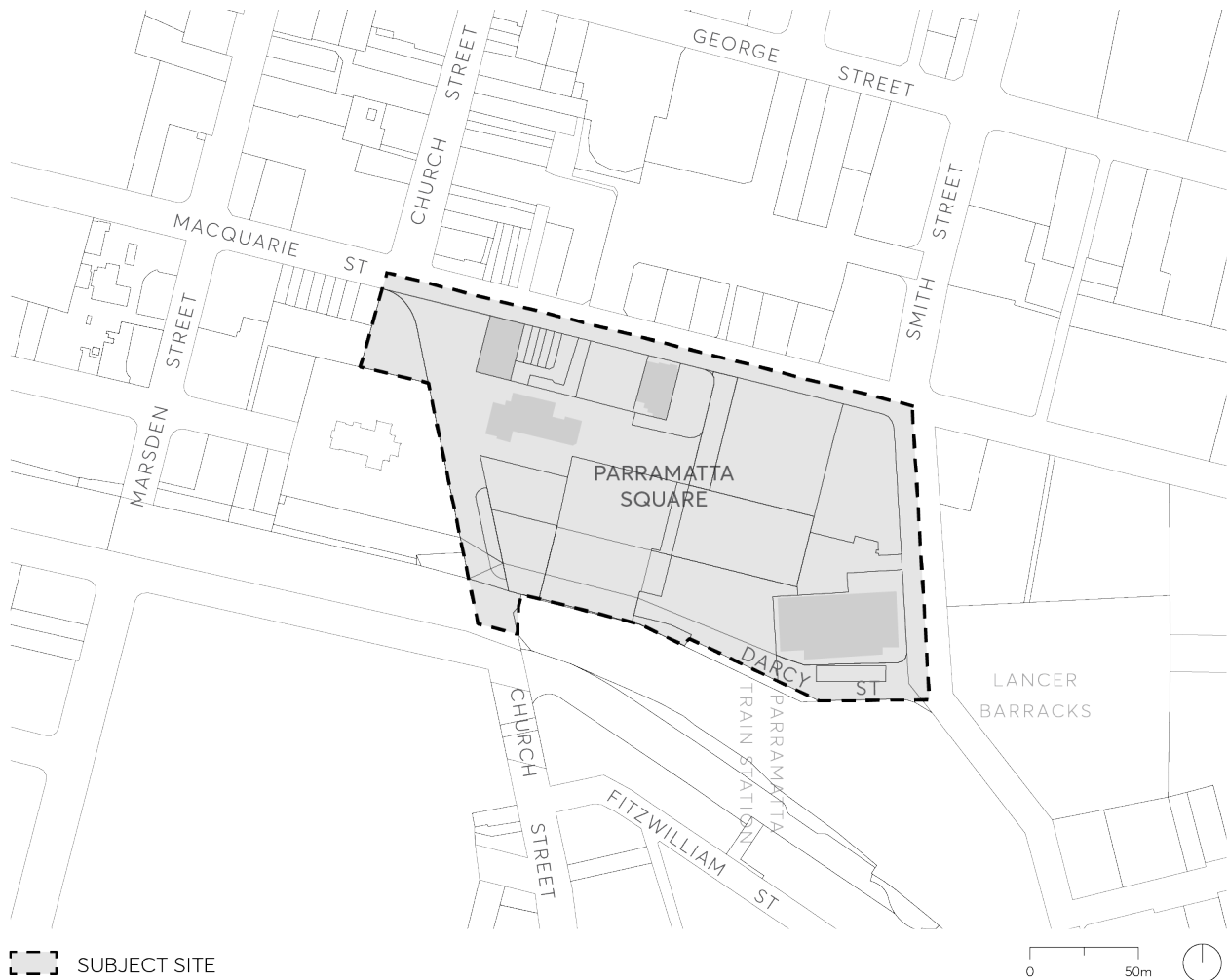

Figure 9.10.1 – Land application map

This **Section must** be read in conjunction with other parts of Parramatta DCP 2023 and the *Parramatta LEP 2023*. If there is any inconsistency between this Section and other Sections of the Parramatta DCP 2023, this Section prevails.

9.10.1.1 DESIRED FUTURE CHARACTER

Parramatta Square, formerly known as Civic Place, is at the heart of the Parramatta City Centre located adjacent to the Parramatta Transport Interchange. Its redevelopment strengthens Parramatta as the Metropolitan Centre for the Central City District and as a centre for business, tourism, entertainment, culture and heritage.

The development of Parramatta Square is vital to showcasing design excellence and environmental sustainability excellence for the city and region as well as achieving the targets for future employment growth by providing direct opportunities and generating flow on effects. The eastern

part of Parramatta Square will contain employment in premium office space. The remainder of Parramatta Square accommodates a mix of commercial, residential, retail, cultural and entertainment uses, that are compatible with the City Centre location and contribute to enlivening the City Centre at all times.

Building on the renewed transport interchange, Parramatta Square provides an easily accessible civic focus. The built form of Parramatta Square is defined by a row of the tallest buildings in Parramatta immediately north of the railway station, and a large central public open space. The space is enclosed by a series of buildings fronting Macquarie and Smith Streets. All of the buildings demonstrate design excellence, commensurate with their important civic location.

Parramatta Square is a public gathering place. The public open space at the centre of Parramatta Square forms the pre-eminent ceremonial centre of Parramatta, the site for both significant formal civic events and recurrent cultural and community celebrations and festivals.

Local residents grow accustomed to attending a variety of gatherings in Parramatta Square. The design of the public open space reflects the nature of its use and is of high quality.

Given this character, vehicle movements is restricted and pedestrian and cycle movement dominate.

9.10.1.2 SITE REQUIREMENTS

General objectives

The objectives will determine the future form of development and establish the key parameters that will ensure that future development achieves the overall desired future character.

- O.01 Reinforce the City's street grid pattern and ensure that Parramatta Square is integrated with Parramatta's urban structure.
- O.02 Retain a civic focus on the site.
- O.03 Establish a legible hierarchy and location of public domain spaces that complement Parramatta's existing and proposed public space network.
- O.04 Define vehicular access to support the public space and provide access to and address points to buildings.
- O.05 Locate major and direct pedestrian routes to the Parramatta Transport Interchange.
- O.06 Reinforce and improve existing and proposed north-south pedestrian links.
- O.07 Ensure new development maximises its potential to integrate precinct and individual building technology and infrastructure to help reduce its demand for resources such as energy and water and demonstrate excellence in environmental sustainability.
- O.08 Provide a well-balanced mix of uses that promote a sense of community and support the communities Parramatta serves, especially at ground level.
- O.09 Activate the ground floor public domain and civic areas to create a vibrant precinct, which is activated day and night.

- O.10 Establish social uses such as markets, cafes, restaurants, and bars and allow them to spill out into the public squares, streets, arcades and laneways.
- O.11 Ensure residential uses provide a high level of amenity.
- O.12 Allow opportunities for innovative planning and urban design.
- O.13 Ensure that the central and western part of Parramatta Square is not dominated by any one use. A mix of uses including retail, commercial, residential, community, civic, cultural and entertainment is sought as a means of enlivening the precinct.
- O.14 Provide appropriate solutions for:
 - an optimal pattern of buildings and open spaces,
 - public domain interfaces, and
 - an integrated approach to access, parking and servicing.

Site Objectives

The site offers a unique opportunity to create a series of new public open spaces that can form a focus for Parramatta.

- O.15 Provide a range of robust and flexible public spaces that will cater for a variety of public celebrations, events and functions.
- O.16 Ensure a high level of pedestrian amenity and safety through the inclusion of weather protection (e.g. awnings, colonnades) lighting and safety by design principles.
- O.17 Protect public safety through locating diverse, active uses on main pedestrian routes.
- O.18 Allow for buildings to overlook public spaces to improve surveillance and safety.
- O.19 Ensure ongoing active uses in public open space such as markets, entertainment and events and outdoor dining.
- O.20 To recognise the scale of St John's Cathedral including the ridge and spire elements.
- O.21 To ensure that successively designed buildings present visually integrated elevations to Parramatta Square and work collectively to frame and form a coherent and legible 'urban room'.

Controls

- C.01 Provide a total of 6,000sqm of public open space across the site (excluding Church Street Mall from calculation). At least 3,000sqm with a minimum width of 40m is to form one contiguous area in the centre of the site, as shown on Figures 9.10.1.2 and 9.10.1.3. Encroachments up to 6.5 metres into the 40 metre minimum width zone may be considered where justified by an agreed design excellence rationale.
- C.02 Building Elevations facing Main Square, Station Square and Eastern Square (as described in Figure 9.10.1.3 should relate to one another to maintain a consistent approach to the public domain. Critical issues that will be taken into account when considering proposals are:

- a) That setbacks at ground and higher levels are complimentary to create a view corridor through the square that encloses the view to St John's Cathedral
 - b) That horizontal design elements of existing buildings fronting onto the square are brought across and incorporated into the façade treatments of new buildings to unify the buildings on the square. In particular, horizontal design elements at a height at or close to 18 metres above the square should be transitioned from site to help define the 'urban room'.
- C.03 Overshadowing is to be minimised within the area outlined in red in Figure 9.10.1.2. Individual buildings shall be designed so that no single point of the area outlined in red is in shadow for a period greater than 45 minutes between 12pm-2pm mid-winter.
- C.04 The public open space is to be formed by a progression of spaces or squares crossing the site from east to west, each with their own character, as shown in Figure 9.10.1.3. The squares are to comply with the [Parramatta Public Domain Guidelines](#) and are to have:
- a) quality paving and urban elements,
 - b) public art that is appropriate to the site, and
 - c) maximise soft landscaping while providing sufficiently sized hard paved event spaces.
- C.05 In addition to streets and lanes, to enhance public circulation a number of pedestrian through site links as shown on Figures 9.10.1.2 and 9.10.1.3 are to be created which respond to the existing and proposed system of lanes and mid-block pedestrian connections.
- C.06 The through site links are to comply with Section 6.3 'Laneways' in [Parramatta Public Domain Guidelines](#) and to have:
- a) A minimum width of 6m and clear sightlines.
 - b) Minimum double storey height for 80% of the arcade.
 - c) Natural light where possible.
- C.07 Colonnades may be appropriate to provide shade and shelter. Where colonnades are proposed they must:
- a) Be continuous for the entire public domain frontage.
 - b) Have a minimum width of 4.5m between columns at ground level.
 - c) A minimum height of 4.5m to underside of soffit.
- C.08 Any proposals for public domain on top of a structure are to be visible, clearly marked, and accessible from at least two points.

9.10.1.3 BUILDING FORM

The development provisions on building form in this section are intended to encourage high quality design for new buildings, balancing the character of Parramatta with innovation and creativity. The resulting built form and character of new development should contribute to an attractive public domain in central Parramatta and produce a desirable setting for its intended uses.

Objectives

- O.01 Establish high quality architectural and urban design for public spaces and buildings.
- O.02 Design buildings with high level of environmental performance to encourage comfort and full occupation.
- O.03 Incorporate noise attenuation features in buildings to minimise the effects of noise generated by activities in adjacent open space and the nearby railway line.
- O.04 Design buildings and open space to minimise wind generation and effects through building form, articulation, screening, galleries and the like.

Controls

- C.01 The pattern of buildings on the site is to create a central public open space generally at existing ground level with a direct connection to the adjacent transport interchange as shown in Figures 9.10.1.2 and 9.10.1.3.
- C.02 New buildings are to have street frontages predominantly built to the street and public domain alignment.
- C.03 Provide for additional footpath width at the corner of Macquarie and Smith Streets to accommodate pedestrian intensity in this location.
- C.04 Development on land fronting Macquarie Street must recognise the heights of the heritage buildings and reflect the predominant datums (5-6 storey podiums and 2-3 storey heritage buildings) within this part of the street, through a recessed podium, colonnade, strong shadow lines or similar.
- C.05 Commercial towers on land fronting Macquarie Street may be built to the street frontage to limit overshadowing to the public space to the south.
- C.06 Residential towers on land fronting Macquarie Street require a podium and setback to the tower for amenity reasons.
- C.07 Overshadowing is to be minimised within the area outlined in red in Figure 9.10.1.2. Individual buildings shall be designed so that no single point of the area outlined in red is in shadow for a period greater than 45 minutes between 12pm-2pm mid-winter.
- C.08 All development is to implement:
 - a) heritage conservation principles,
 - b) sustainable development principles, particularly in regards to energy and water minimisation, waste minimisation and adapting to the impacts of climate change,

- c) safety by design principles, and
- d) equal access to all facilities as required by legislation.

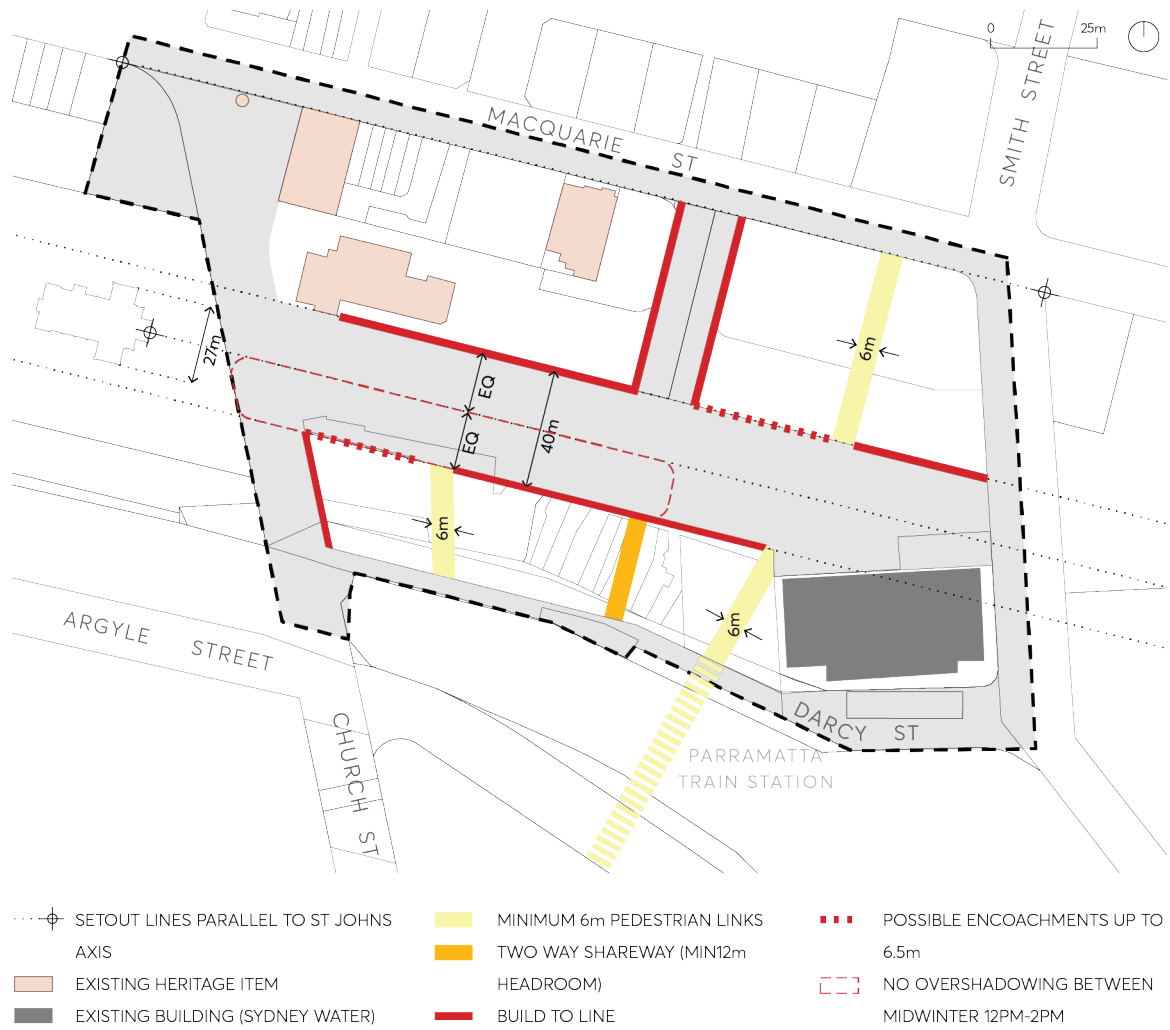

Figure 9.10.1.2 – Public Space Set Out



Figure 9.10.13 – Public Space Principles

C.09 The detailed requirements in Figure 9.10.13 - Public Space Principles are provided below:

1. Main Square:
 - i. Main Civic Space
 - ii. Minimum 3,000 sqm with minimum dimension 40 metre with consistent edge alignment
 - iii. Ceremonial public area designed to be the symbolic centre of Parramatta
 - iv. Accommodate a rich program of events
 - v. Limited vehicle access
2. Leigh Place:
 - i. Main northern entrance to Parramatta Square from the River Link and Macquarie Street
 - ii. Accommodate vehicle and service access
3. Eastern Square:
 - i. Provides address to Smith Street, 169 Macquarie Street and the Sydney Water building
 - ii. Must integrate with raised forecourt of Sydney Water
4. Pedestrian Lanes:

- i. Activated lanes between the railway station, Station Square and Macquarie Street
 - ii. Direct connection to station concourse
 - iii. No vehicles
5. Station Square:
 - i. The hub where the railway station meets the square; a front door to Parramatta City
 - ii. An activated space that facilitates easy pedestrian access, orientation and seamless choice of desired routes and destinations
 - iii. No vehicles
6. Church Street Mall and Centenary Square:
 - i. Retain as Parramatta's most enduring public space, including landscaping and heritage buildings and monuments
 - ii. Ensure access for potential future light rail along Church Street

9.10.1.4 SUSTAINABILITY

The redevelopment of an area as large as Parramatta Square creates an opportunity to consider the precinct as a whole and prepare precinct-wide sustainability initiatives. These could include the provision of building services and precinct infrastructure that supports energy efficiency, water management and waste minimisation; helping to adapt to climate change.

Objectives

- O.01 Incorporate building services and precinct infrastructure that reduces the demand for energy and water resources.
- O.02 Implement the principles of Water Sensitive Urban Design on an individual building and precinct scale.
- O.03 Minimise the use of natural resources through resource recovery and waste avoidance measures.
- O.04 Ensure that buildings are designed to inhibit wind funnelling and that the major public spaces are screened from winter winds and open to cooling summer breezes.
- O.05 Provide structures such as colonnades and awnings to give shelter to pedestrians and opportunities for sitting out in the sun in winter and in the shade in summer.
- O.06 Minimise reliance on mechanical ventilation and reliance on artificial lighting by implementing passive design measures.
- O.07 Use landscape design to modify summer and winter climatic conditions and improve amenity for people using the open space.
- O.08 Maximise energy efficiency in building design, orientation, and siting.

Controls

- C.01 Building design and construction should achieve a minimum 5 star Green Star Design and as Built rating, respectively.
- C.02 Building operation should achieve a minimum 4.5 star base building and tenancy NABERS Energy rating, where applicable.
- C.03 Residential flat buildings should achieve a minimum 5 star NatHERS energy rating for each apartment.
- C.04 New developments should connect to precinct recycled water infrastructure (where available), e.g. dual water reticulation systems should be installed to enable any future supply of non-potable water to be easily used within the building.
- C.05 Non-potable water uses include toilet and urinal flushing, clothes washing, irrigation, cooling tower make-up water, and wash down facilities. All non-potable water use should be met through connection to the recycled water distributed from the relevant Authority.
- C.06 Where a recycled water supply is not available, new developments shall implement appropriate future proofing measures to support connection should a recycled water supply become available.
- C.07 New developments should connect to precinct energy infrastructure (where available), including:
 - a) The provision of heating energy to the mechanical air conditioning systems through connection to the heating hot water distributed from a Central Thermal Plant.
 - b) The provision of hot water for the production of domestic hot water through connection to the heating hot water distributed from a Central Thermal Plant.
- C.08 New developments should optimise building services design for connection to precinct energy infrastructure (where feasible) to facilitate efficient and economic operation and maximise environmental benefits of the precinct energy services.

9.10.1.5 ACCESS, PARKING AND SERVICES

A street network appropriate for purpose is critical for a functioning City Centre. Giving frontage to buildings need to be balanced with creating a public domain that prioritises pedestrian movement.

Objectives

- O.01 Ensure that new development in Parramatta Square addresses the street.
- O.02 Provide for limited vehicular access into the centre of the site.
- O.03 To support the reduction of car trips and encourage the use of sustainable transport.
- O.04 Ensure that Parramatta Square functions as the northern gateway to the Parramatta Railway Station and Bus Interchange.

Controls

- C.01 New streets, lanes, public spaces and vehicles access points to buildings in Parramatta Square are to be consistent with the pedestrian and vehicle access principles in Figure 9.10.1.4 and the public spaces principles shown on Figure 9.10.1.2.
- C.02 Allow for a possible shared access and servicing zone along the length of the Parramatta Station entrance frontage along Darcy Street.
- C.03 Consideration should be given for the provision of electric vehicle charging stations on the site.
- C.04 Provide adequate public access and sunlight along Darcy Street.
- C.05 Commuter bicycle parking (short and long term) is to be provided on the site.
- C.06 Individual developments will be required to provide car-share parking spaces that are available for use by the public and car share members.
- C.07 Written evidence must be provided with the development application demonstrating that offers of a car space to car-share providers have been made together with the outcome of the offers or a letter of commitment to the service.
- C.08 Ensure that the following on-street parking uses are accommodated: pick up/set down for rail passengers; taxis; rail replacement buses; the loop bus; buses for special events at Rosehill Racecourse and UWS; coaches for any hotel or tourist facility in the precinct; maintenance of the precinct and rail assets; and short stay parking for loading, library use, and couriers.
- C.09 Detailed public domain designs should include shared pedestrian and cycle access.
- C.10 Development Applications are to be informed by a precinct-wide traffic management study.



Figure 9.10.1.4 – Pedestrian and Vehicle Access Principles

9.10.1.6 HERITAGE

The site includes a number of heritage items identified in Schedule 5 of *Parramatta LEP 2023*. The LEP also sets out the controls for both works to heritage items and development in the vicinity of heritage items.

Objectives

- O.01 Conserve the heritage significance of the site by retaining key heritage buildings and settings.
- O.02 Protect and enhance the views to and from heritage buildings, such as St John’s Church, the Town Hall and Leigh Memorial Church in the design of spaces and buildings.
- O.03 Interpret Parramatta’s indigenous and cultural heritage in the design of buildings, public spaces and public art in Parramatta Square.
- O.04 Interpret the location of the original marketplace, the convict drain, and the site’s archaeology.
- O.05 Conserve and where appropriate, adaptively re-use archaeological resources in public interpretation to enrich public spaces.

- O.06 Develop an interpretation program that derives from the special qualities and associations of the site for the people of Parramatta and the region.
- O.07 Ensure future development of the site enhances the heritage qualities of the site.

9.10.1.7 PUBLIC ART

Public art will contribute a strong sense of "place" - the identity and interpretation of Parramatta Square itself - with artwork/s situated in the open spaces, walkways and built into the fabric and form of architecture and landscape.

The Parramatta Square Public Art Masterplan provides a curatorial framework that guides Developers in the direction and implementation of a site-specific public art program for Parramatta Square.

Objectives

- O.01 Present a curated approach to public art programming that benefits the public realm.
- O.02 Enhance public places with distinctive character in which art is an integral part of the built environment.
- O.03 Ensure the culture, aspirations and history of Parramatta is reflected in the art and architecture and landscape.

Controls

- C.01 Public art is to be provided in accordance with the Parramatta Square Public Art Masterplan.
- C.02 Public art in Parramatta Square is to comply with the [Parramatta Public Art Policy](#) presenting work that has a strong relationship to its historical, social, architectural, environmental, contemporary and geographical context.
- C.03 Planning for public art is required for all projects as part of the Development Approval process to enable the early integration of art with the detailed fabric and form of architectural, urban place and landscape designs.

9.10.1.8 UTILITIES

The location of utilities and services can have an adverse effect on the public domain where their placement is ill-considered. Utilities such as substations have a significant presence if poorly placed. Service access points can also dominate important streetscapes. The location and design of such items needs detailed attention particularly where they are about the public domain.

Objectives

- O.01 Ensure that the service access points to buildings are concealed as far as possible on major pedestrian routes.
- O.02 Locate substations within development rather than the public domain.
- O.03 Where utilities are visible from the public domain, ensure their appearance and design is of the highest quality.

Controls

- C.01 New development is to amalgamate and/or share utilities between buildings to minimise visual, environmental and access impacts.
- C.02 Service access points and substations are to be minimised along major pedestrian route and adjacent to public open space. Where necessary, their design is to be incorporated into the overall building.
- C.03 Proposed buildings should be designed so as to maximise opportunities for the application of current and future technologies, in terms of the provision of technological infrastructure, and the application of building integrated management systems.

9.10.2 57, 63 AND 83 CHURCH STREET AND 44 EARLY STREET

This Section applies to land at 57, 63 and 87 Church Street and 44 Early Street, Parramatta. The subject land comprises 3 parcels fronting Church Street and the Great Western Highway, Early Street and Lansdowne Streets, as shown in Figure 9.10.2.



Figure 9.10.2 – Land application map

This Section must be read in conjunction with other Sections of this DCP and *Parramatta LEP 2023*. If there is any inconsistency between this Section and other Sections of Parramatta DCP 2023, this Section prevails.

This Section establishes objectives and controls to be interpreted during preparation and assessment of development applications and supports the objectives of the LEP.

9.10.2.1 DESIRED FUTURE CHARACTER

The redevelopment of these sites into a mixed use precinct enables the revitalisation of Church Street, and reinforces the character of the City Centre as a destination for employment, retail and high density living.

The sites' introduce high density residential dwellings and a mix of commercial and retail space that transforms the local character into an exciting pedestrian friendly precinct.

The sites' location within walking distance of the City Centre core including the Parramatta Transport Interchange as well as Harris Park Rail Station reducing car dependence and promoting the use of sustainable public transport as well as walking and cycling transport options for residents and business.

The mix of uses provides jobs to increase activity in the City Centre. The redevelopment provide a range of apartment dwellings in high-density building forms, meeting the needs of different household types.

A revitalised public domain is a key component of the redevelopment. A series of pedestrian walkways connecting the 3 parcels of land activate the street level and provide an internal access network.

The sites are a catalyst for future development in Auto Alley aimed at reflecting the Parramatta City Centre as the Metropolitan Centre for the Central City District.

9.10.2.2 SITE OBJECTIVES

Objectives

- O.01 To create an urban environment that provides a mix of uses including high density residential, commercial, retail and community facilities.
- O.02 To ensure built form articulation and an attractive composition of building elements with a strong relationship between buildings and streetscape.
- O.03 To provide appropriate public domain elements, including internal pedestrian walkways, footpaths, open space for the benefit of the existing and future community.
- O.04 To ensure building height is distributed across the site having regard for orientation, overshadowing, and views and vistas suitable for this gateway to Parramatta.
- O.05 To provide opportunity for future car showroom functions on the ground level.
- O.06 To provide local amenities for existing and new residents with a variety of activities, services, and functions to attract people and places for them to meet and stay.
- O.07 To provide an appropriate level of active ground floor uses to increase safety, pedestrian activity and use of public domain areas.
- O.08 To provide a visual and physical connection throughout the site for a high level of surveillance and safety.
- O.09 To accommodate generated traffic, and to mitigate traffic effects.

- O.10 To include stormwater management measures which appropriately address the level of flood affectation on the site and immediate surrounds.

9.10.2.3 PUBLIC DOMAIN

The site offers an opportunity to enhance the public domain through improvements to streets, lanes, plazas and urban parks.

Objectives

- O.01 To create an environment that is comfortable for pedestrians.
- O.02 To ensure a high level of pedestrian amenity, safety and security through the inclusion of weather protection, lighting and safety by design principles.
- O.03 To ensure pedestrian walkway areas are formed from a sequence of spaces and plazas running north-south, connecting all 3 parcels of land.
- O.04 To facilitate and establish social uses of public plaza space and walkways such as cafes, restaurants, bars, markets, with public seating areas.
- O.05 To ensure that where utilities are visible from the public domain, that their appearance and design is of the highest quality.
- O.06 To provide for effective linkages and interfaces between public space and private land and provide a high quality physical setting and surrounds for buildings.

Controls

- C.01 New pedestrian walkways, park and plazas shall be provided in accordance with Figure 9.10.2.2 and should be no less than minimum size indicated in the control table below:

Public Domain	Minimum Size in Sqm (m2)
Northern Plaza/Pedestrian Walkway	1.600
Central Plaza	1.350
Urban Park	1,790

- C.02 Public street frontages are to comply with the [Parramatta Public Domain Guidelines](#) and are to have:
- C.03 Appropriate paving and urban elements;
- Public Art suitable for the site; and
 - Appropriate spaces for outdoor trading and outdoor dining.
- C.04 Pedestrian walkways are to comply with Section 6.3 – Laneways in [Parramatta Public Domain Guidelines](#) and the objectives of the [Parramatta Laneways Policy](#).
- C.05 Pedestrian walkways are to be generally 15m wide, with a 4m zone clear of obstructions to movement to allow for sufficient space for outdoor trading and dining.

- C.06 Awnings and colonnades are to be provided along building frontages along public domain to provide shade and shelter.
- C.07 Where colonnades are provided, they must:
- a) be continuous for the entire public domain frontage or link with awnings;
 - b) have a minimum width of 4.5m between columns; and
 - c) a minimum height of 4.5m to the underside of soffit.
- C.08 The southern site is to be provided as an Urban Park in accordance with 9.10.2.2. The design of this park will balance public access and amenity with safety with water management objectives.
- C.09 To allow for future road widening along an appropriate length of Church Street and the Great Western highway, and to provide a cycle / pedestrian path along the Church Street frontages, as shown on Figure 9.10.2.2.



Figure 9.10.2.2 – Public Domain

9.10.2.4 BUILDING FORM

The development provisions on building form in this section are intended to encourage high quality design for new buildings. The resulting built form and character of development should contribute to an attractive public domain and produce a desirable setting for its intended uses.

Objectives

- O.01 To establish high quality architectural and urban design for buildings.
- O.02 To locate high density housing with good access to retail, employment, transport, and high quality public domain and open space.

- O.03 To provide for a variety of retail experiences by way of new format automotive retail, specialty shops, and supermarket.
- O.04 To provide appropriate articulation of building form that is responsive to street address, microclimate and pedestrian-orientated environment.
- O.05 To ensure that new development minimises and mitigates adverse overshadowing and privacy impact on adjoining public domain and land uses.
- O.06 To ensure the setback of residential towers is at an appropriate distance from heavily used streets of Church Street and the Great Western Highway.
- O.07 To create active streets and plazas by locating fine grain shop fronts at the ground floor with all fronts and entrances at street level.

Controls

Building Envelopes

- C.01 Future built form should be consistent with the building envelopes shown at Figure 9.10.2.3 and Figure 9.10.2.4
- C.02 New buildings along Church Street should not exceed the maximum building depth of 22m, shown on Figure 9.10.2.3 and Figure 9.10.2.4.
- C.03 Residential towers should not exceed the maximum building internal floor plate requirement, shown on Figure 9.10.2.3.

Building Height

- C.04 Building heights shall be in accordance with Figure 9.10.2.3 and Figure 9.10.2.4 to respond to the context, to provide visual interest and to minimise and mitigate adverse overshadowing and privacy impact to adjoining public domain and land use.

Building Setbacks

- C.05 Building setbacks are to be in accordance with Figure 9.10.2.3 and Figure 9.10.2.4.
- C.06 Provide 6m building setback in key locations along the western boundaries of the site as shown on Figure 9.10.2.3 and Figure 9.10.2.4.
- C.07 Where a zero allotment setback is provided a merit assessment will be undertaken with consideration given to the amenity impact on adjacent properties. Consideration should be given to the provision of articulation and high-quality architectural treatment and materials to avoid bland, imposing expanses of wall to neighbouring properties.



Figure 9.10.2.3 – Building Form Control Plan

Building Separation

C.08 Minimum separation between buildings should be in accordance with Figure 9.10.2.3 and Figure 9.10.2.4.

Frontage, activities and entries

C.09 Continuous active frontages are to be in accordance with Figure 9.10.2.3 This should include retail and commercial spaces.

C.10 Access to residential use and commercial use above ground level should be provided directly from plaza or pedestrian walkway.

C.11 Large format retail with floor space exceeding 2,000m² shall be provided at a basement level and accessed directly from a plaza or a pedestrian walkway.

Basement floor space for Site 1

C.12 Of the total commercial floorspace component for Site 1, 6,000m² must be located at a basement level for retail purposes only. The 6,000m² of floorspace cannot be relocated above the basement level if the retail component is not to proceed.

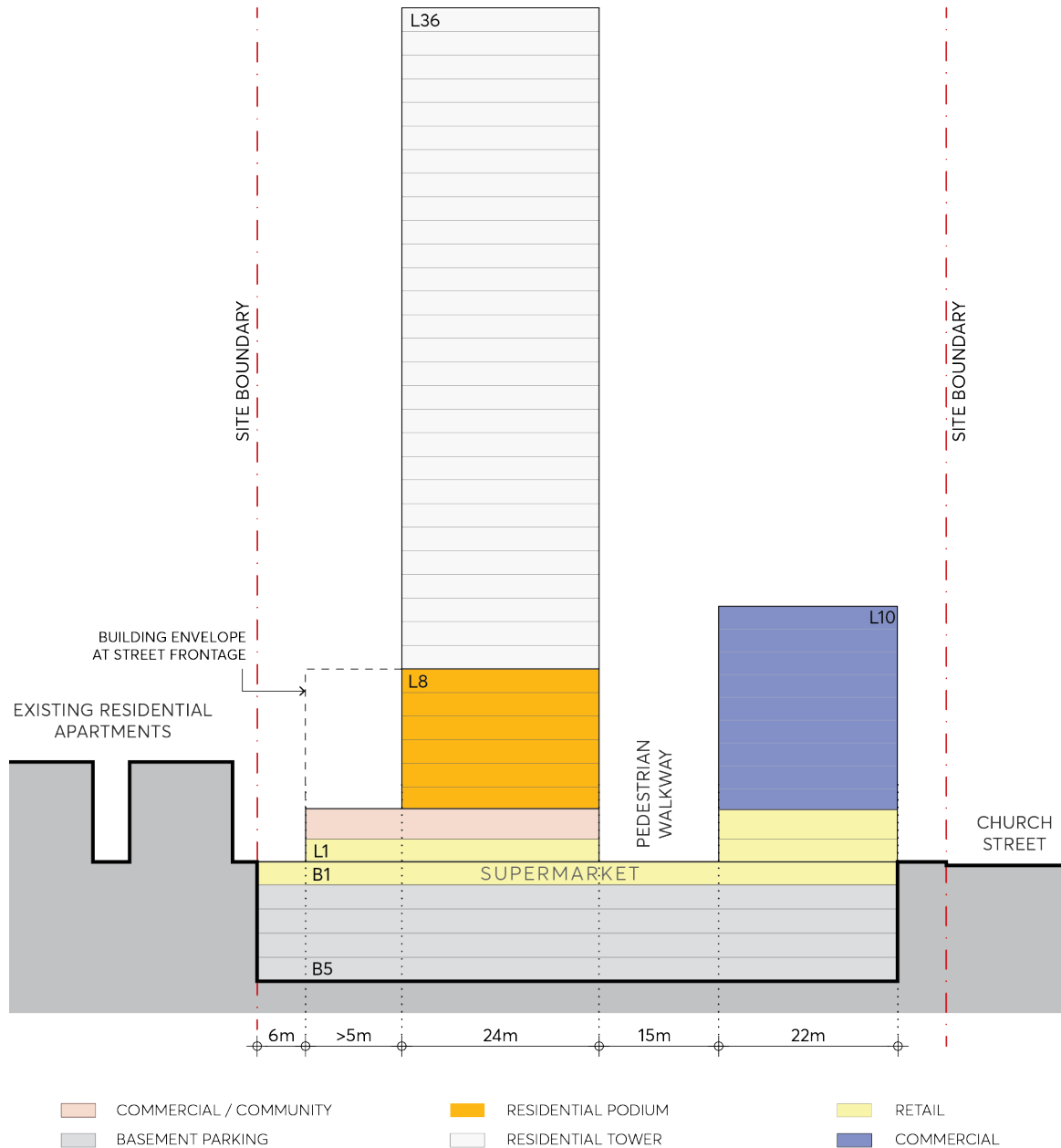

Figure 9.10.2.4 – Building Form Control Section (Northern Side)

9.10.2.5 SUSTAINABILITY, MICROCLIMATE & WATER

Objectives

- O.01 The sites should integrate appropriate sustainability initiatives into individual buildings and the public domain, to address microclimate, energy, and water use.
- O.02 To use landscape design to respond to summer and winter climatic conditions and improve amenity for people using the open space.
- O.03 To ensure the buildings are designed to minimise detrimental wind generation within public and private open spaces.
- O.04 To implement the principles of water sensitive urban design into the design of the public domain.
- O.05 To minimise reliance on mechanical ventilation through applying good climate design principles to building and public domain design

Controls

- C.01 Provide appropriate water management infrastructure in the design of the public domain and urban park, to minimise water use.
- C.02 Incorporate appropriate built form structures/shade structures to create appropriate microclimate in public domain areas, to ameliorate the temperature extremes of summer and winter.
- C.03 To design dwellings to maximise access to sunlight.
- C.04 Residential building designs are encouraged to meet a Green Star – Multi-Unit Residential design rating.
- C.05 Commercial building designs are encouraged to meet Green Star design rating.

9.10.2.6 ACCESS, PARKING AND SERVICING

Provide access for vehicles to the site balanced with pedestrian amenity, access, and safety.

Objectives

- O.01 To provide for safe and easy access for all pedestrians, cyclists, vehicles to buildings and public domain.
- O.02 To locate vehicle access points into buildings to minimise pedestrian and cycle conflicts.
- O.03 To ensure that service vehicle access points are concealed as far as possible on major pedestrian routes.
- O.04 To provide all parking underground for residents and visitors to ensure an active, vibrant, and car-free public domain.

- O.05 To implement appropriate traffic management measures on Early and Lansdowne Streets.
- O.06 To encourage an improved level of pedestrian connectivity of the site to the City Centre.

Controls

- C.01 Footpaths, cycle links, pedestrian walkways, plazas and vehicle access points to buildings are to be consistent with the pedestrian and vehicle access principles as shown on Figure 9.10.2.5.

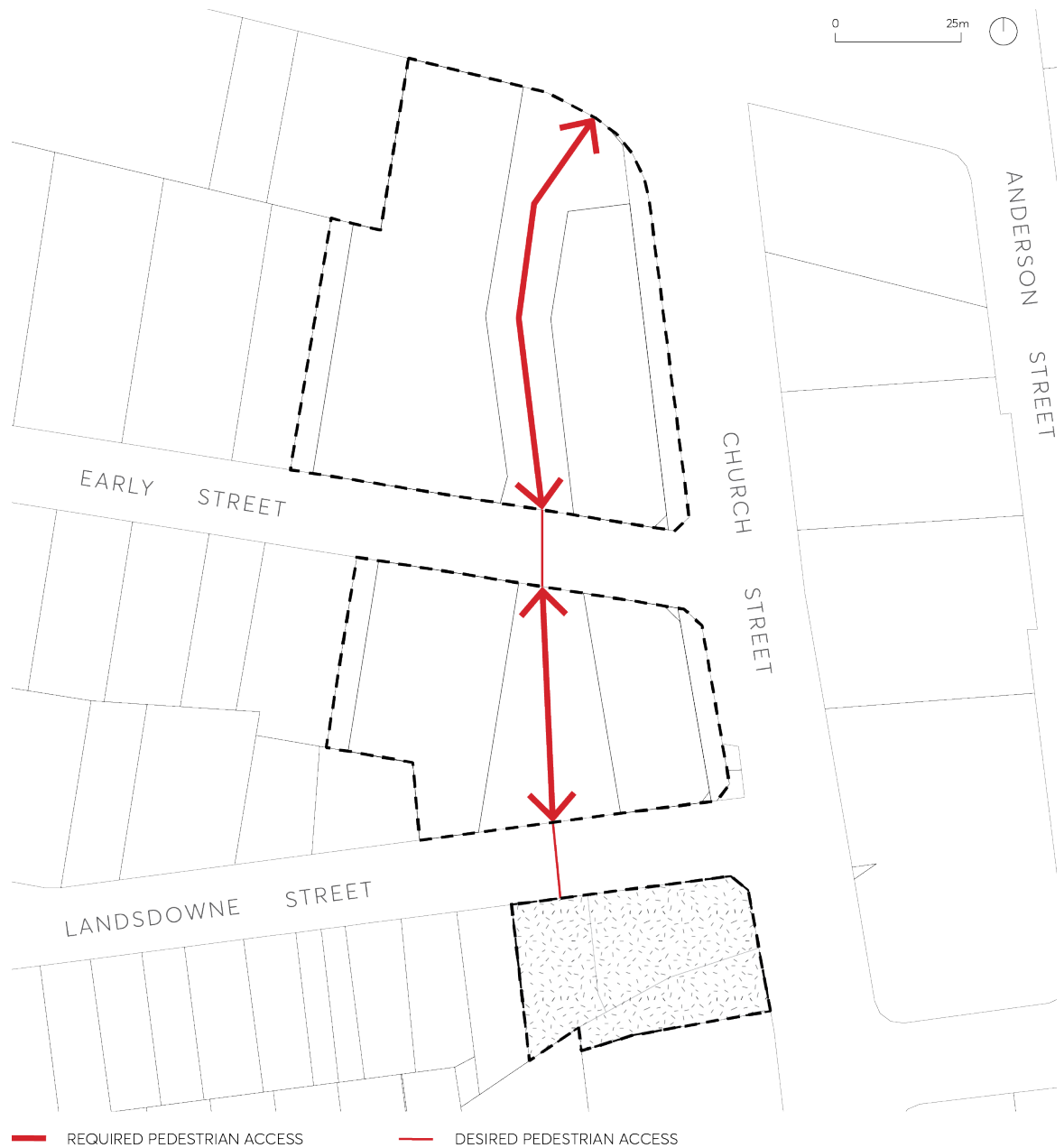

Figure 9.10.2.5 – Access and Servicing

- C.02 Service vehicle access points and utilities are to be minimised along pedestrian routes and adjacent public open space. Where necessary, utilities are to be incorporated into building design.

- C.03 Locate public bicycle racks on ground level, on the street and within the pedestrian walkways linking to key destinations within the development and the cycle network.
- C.04 Locate traffic management measures and pedestrian crossings on Early and Lansdowne Streets to enable the continuation of the pedestrian walkway and priority access for pedestrians.
- C.05 The development of the northernmost site should not preclude future pedestrian connection across (over or under) Church Street or Great Western Highway.
- C.06 Provide for the future road widening of Church Street.

9.10.3 180 GEORGE STREET

This Section applies to 180 George Street, Parramatta situated at the intersection of George and Charles Street. The site comprises Lots 201-204 in deposited plan 1082194 and SP74916 as illustrated in Figure 9.10.3.



Figure 9.10.3 – Land application map

This Section is to be read in conjunction with other Sections of Parramatta DCP 2023 as well as the relevant provisions in *Parramatta LEP 2023*. If there is any inconsistency between this section and other sections of the DCP, this section prevails.

9.10.3.1 DESIRED FUTURE CHARACTER

New development supports the Parramatta City Centre in its role as a Metropolitan Centre with easy access to public transport, entertainment and recreational facilities. New development is to respond to the site’s unique setting adjacent to the Parramatta River and open space.

New development provides a design response that is sensitive to the adjoining heritage context whilst responding to the future envisaged scale of the City Centre. Harrisford House, a state heritage listed item, is situated immediately to the east. Minimum setback distances between the heritage item and new development are observed.

The redevelopment of the site establishes active edges for the ground level of retail/serviced apartments and other non-residential uses to the surrounding streets and the river, whilst integrating with its immediate context. Slender articulated tower forms of varying heights are realised with a podium of above ground car parking. George Street and Charles Street which form the major frontages to the site. Design is to encourage activation to these streets through the provision of non-residential uses at ground floor level.

The river frontage and eastern edge of the development at ground level (interface with Harrisford House) forms secondary frontages with public access links and activation through the provision of childcare facilities, retail uses, serviced apartments or other non-residential uses.

A high level of connectivity through and around the site is achieved. Future redevelopment is provides an "open air" through site link along the site's eastern boundary adjacent to Harrisford House which opens up a secondary access corridor from George Street to and from the river foreshore reserve. A public access link along the river frontage provides a continuous public connection above the flood level and increases pedestrian access to the surrounding street network.

Site Objectives

- O.01 Ensure future development of the site respects the curtilage of the adjoining heritage item (Harrisford House).
- O.02 Maintain the site through link along the site's eastern and northern boundary to and from the river foreshore reserve to George Street at this side.
- O.03 Redevelop the site to allow for a high quality development comprising a mix of uses including high density residential, retail and community facilities.
- O.04 Deliver a design approach that adds visual interest and diversity to the city skyline.
- O.05 Integrate new built form with existing development in the subject block.
- O.06 Integrate new site linkages with surrounding development context and topography.

Controls

- C.01 Street Wall and Building Height
 - a) Figure 9.10.3.2 illustrates the maximum permitted podium heights for the development:
 - A maximum street wall height of 3 storeys to George Street to provide an interface with the adjoining heritage item to the east.
 - Provide a minimum 6 metre tower setback from the edge of George Street.
 - b) Where new development involves the demolition of the existing serviced apartment building fronting Charles Street, a maximum street wall height of 6 storeys to the Charles Street frontage will apply.
 - c) Where more than one tower form is proposed variable building heights should be developed to add visual interest to the skyline. A minimum height variation of 10 storeys between the towers is required.

C.02 Building Setbacks and Envelopes

- a) Building setbacks and envelopes are to be in accordance with Figure 9.10.3.2.
- b) At street level open pedestrian path is to be provided along the full length of the eastern boundary of the site adjacent to Harrisford House as shown in Figure 9.10.3.2 consisting of a minimum 6 metre setback to the site's boundary with Harrisford House. The setback zone will be occupied by a through-site link between George Street and the river foreshore reserve.
- c) Encroachments into the 6 metre setback along the site's eastern boundary in the form of balconies and other projecting elements are not supported.
- d) Above podium level, a minimum setback requirement of 12 metres applies to the eastern boundary adjacent to Harrisford House.
- e) A 6 metre ground level setback along the northern boundary is required to facilitate a public access link comprising minimum of 4.5 metre for a public walkway and 1.5 metre for retail activation.
- f) Where a colonnade is constructed along the northern boundary it should be double storey in height

C.03 Building Separation and integration

- a) The existing serviced apartment building fronting Charles Street may be retained where fully integrated with new development.
- b) The finished levels and design of the through site links are to provide:
 - an appropriate continuity with the finished levels of Harrisford House and its curtilage; and
 - an accessible connection: between the pedestrian links at the site, to the start of a future public link to the Parramatta River foreshore and to the pedestrian links on neighbouring sites and adjoining streets.

C.04 Building Articulation

- a) The floor lines and heights of Harrisford House are to be used as a reference point for the articulation of the adjoining lower levels of new development on the subject site.
- b) Muted façade treatments sympathetic to the heritage item adjacent are to be provided to the new development's eastern elevation.

C.05 Street Activation

- a) Active uses are required at ground level along Charles and George Streets.
- b) A high level of permeability through and around the site is to be achieved.

C.06 Parking

Where above ground parking is provided it must be well integrated into the overall façade design and not be visible from the public domain without sleeving or appropriate architectural screening.

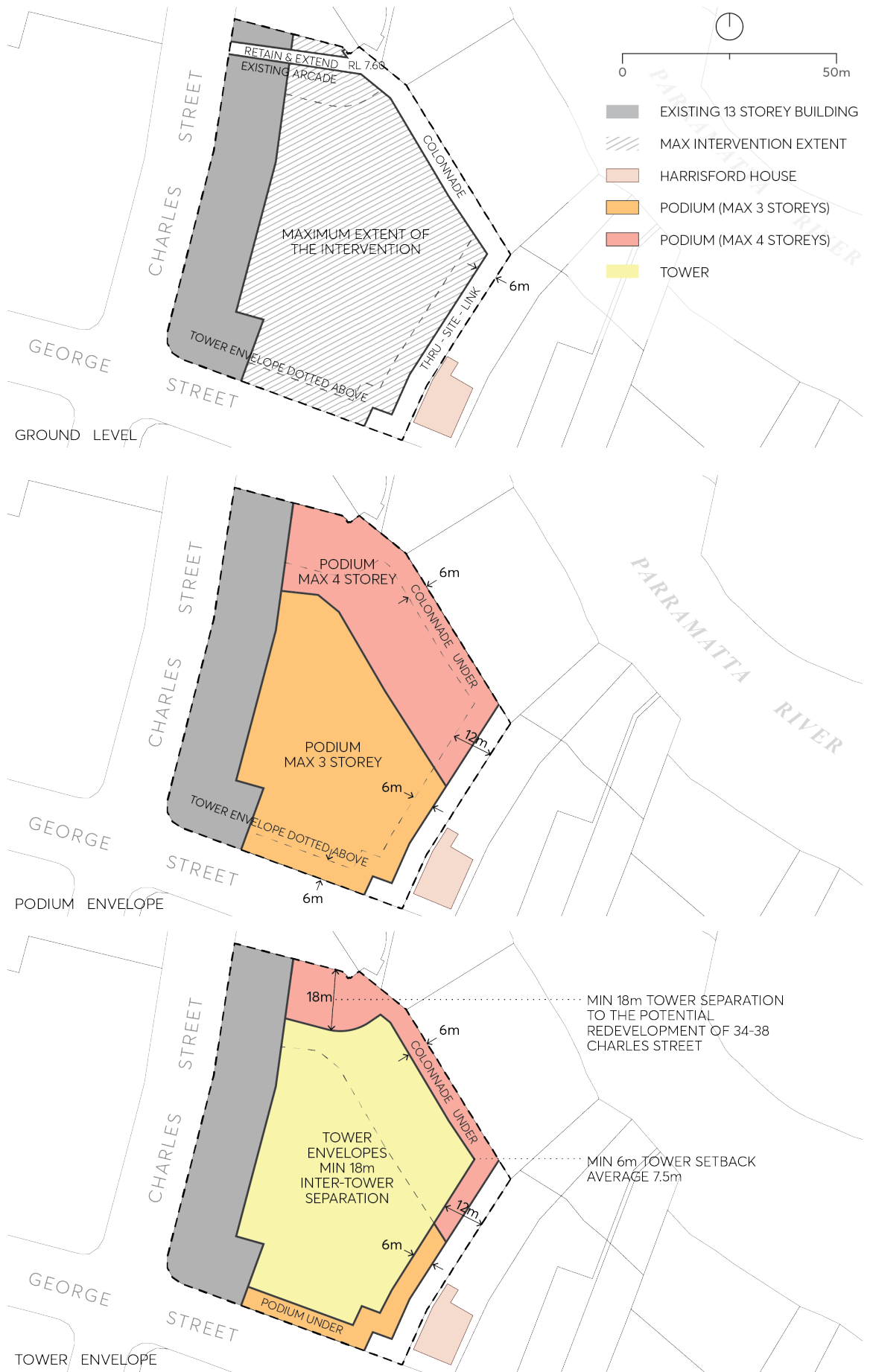

Figure 9.10.3.2 – Building heights, setbacks and envelopes

9.10.4 2-10 PHILLIP STREET

This Section applies to land at 2-10 Phillip Street, Parramatta (the 'subject site') as shown in Figure 9.10.4.



■ SUBJECT SITE

Figure 9.10.4 – Land application map

This Section is to be read in conjunction with other sections of Parramatta DCP 2023 as well as the relevant provisions in *Parramatta LEP 2023*. If there is any inconsistency between this Section and other parts of the DCP, this Section prevails.

This Section establishes objectives and controls to be interpreted during preparation and assessment of development applications and supports the objectives of the LEP.

This Section should also consider the *Principles for Site Specific Development Control Guidelines 2016*, prepared by TKD Architects.

9.10.4.1 DESIRED FUTURE CHARACTER

Future development at 2-10 Phillip Street is designed to respond to the surrounding future built form context and existing heritage significance and contributes to creating a gateway to the Parramatta City Centre when crossing the Parramatta River to reinforce the City Centre's prominence and role.

New development enhances the existing heritage buildings on the site, the former St Andrew's Church and hall, with appropriate building envelopes, conservation of heritage fabric and adaptive reuse and in accordance with this Section and the *Principles for Site Specific Development Control Guidelines, 2016*, prepared by TKD Architects.

Site Objectives

- O.01 To facilitate redevelopment of the site as a high-quality mixed use development.
- O.02 To conserve and enhance the existing heritage item (former St Andrew's Church and Hall group) located on the site and interpret Parramatta's indigenous and cultural heritage in the design of buildings, public spaces and public art.
- O.03 Encourage future uses that are compatible with the Parramatta City Centre and heritage significance of the existing buildings.
- O.04 Protect and enhance views to the site's heritage buildings from the public domain.
- O.05 To ensure development does not encroach on the visual or built integrity of the Church.

Controls – Heritage

- C.01 Heritage fabric
 - a) Conserve the heritage significance of the site by retaining identified heritage buildings and settings.
 - b) Ensure future development of the site enhances the appreciation of the heritage qualities of the site, its values and significance.
 - c) Ensure the conservation of the identified significant building elements, fabric, spaces, internal relationships and context.
 - d) Maintain the integral relationship between the significant buildings and their context.
 - e) Accommodate the activities, services and fittings, which are essential to the new use without damaging significant spaces, elements, or fabric.
- C.02 Interpretation
 - a) Interpret Parramatta's indigenous and cultural heritage in the design of buildings, public spaces, and public art.
 - b) Develop an interpretation program that derives from the special qualities and associations of the site for the people of Parramatta and the region.
- C.03 Archaeology

- a) Conserve and where appropriate, adaptively re-use archaeological resources in public interpretation to enrich public spaces.

C.04 Future uses & adaption of building components

- a) Future uses should be compatible with the nature and significance of the building components and should enable the building to remain a vital and important component of the Parramatta City Centre.
- b) The adaptation of all building components is acceptable, with compatible new uses selected that utilise the original character or permit a creative and responsible re-use of the fundamental architectural, functional and spatial characteristics.
- c) Alterations to the primary external facades to suit new uses may be permitted to meet approved access or similar requirements, provided these are subservient to the primary architectural features and composition of the existing facades and the structure and the quality of the architectural design, materials and detailing of the alterations respects the quality and architectural design of the existing façade.
- d) Adaptation of the buildings' interiors should ensure that the original fabric or significant architectural and spatial features are retained and interpreted as far as possible.

C.05 Possible core location

- a) The core location shall be optimised to ensure suitable conservation of heritage fabric.
- b) In finalising core options, new development should also consider the additional heritage and core analysis provided in the Principles for Site Specific Development Control Guidelines, 2016, prepared by TKD Architects.
- c) Any intervention in the Hall should aim to minimise heritage impacts by careful detailing of the core with extensive use of glass and discreet structural interventions to maximise the visibility of the original fabric and spatial volume. The rear section of the Hall has been extensively altered in the past, with construction of kitchens and basement toilets, so new modifications should be located in this part of the Hall to minimise disruption of more intact fabric. Any movement of the core to the East would reduce adverse impacts on the Hall.
- d) Externally, as the core and ground level building envelope are set back 14 metres from the Phillip Street boundary, the Church and Hall roof must be able to be 'read' from the eastern service lane and Marsden Street corners (see Figure 9.10.4.7).

C.06 Vehicular access

- a) Vehicular access may be from the eastern service lane in the north-east corner of the site.

C.07 Views

- a) Protect and enhance the views of the site's heritage buildings and their street presentation (see Figures 9.10.4.4 to 9.10.4.7 in Control C.09 Development Envelope Guidelines).
- b) The view of the Hall roof should be retained, and the setback from the street boundary should be approximately 14 metres up to a height of approximately 30 metres (see Figure 9.10.4.7).

C.08 Development in the vicinity of the heritage items

- a) New development should generally not encroach on the visual and built integrity of the church (see the development envelope controls in Control C.09). The internal site boundary with the Church Hall should determine the side perimeter curtilage, to constrain adjacent development above the ground plane and maintain the spatial relationships between the site's heritage buildings.
- b) The church and hall should both be able to be 'read' from the surrounding public domain. Double or triple height glazing should be provided to lower levels to allow greater exposure of the hall buildings from different areas of the public domain.
- c) Development should provide a transition in building height from a heritage place to the tower structure through the use of podiums, awnings, voids or similar design features, and not create an overbearing appearance.
- d) Any cantilever element to the tower should form a respectful relationship with the former St Andrews Church through consideration of separation, massing, and materiality (See Figures 9.10.4.4 to 9.10.4.10 in Control C.09 Development Envelope Controls). The prominence of the Church spire should not be compromised by a tower cantilever. There should be no tower cantilever over the Church.
- e) The extent of any tower cantilever should be constrained and regulated by nominated critical view lines that must be protected, including the view of the Hall roof from the corner of Phillip Street and the eastern service lane, and the clear silhouette of the Church steeple viewed from Marsden Street. The tower cantilever toward Phillip Street should not extend past the line of the facade of the Hall up to a height of 30 meters. The tower cantilever above this height could extend to the Phillip Street boundary. See Figures 9.10.4.4 to 9.10.4.10 in Control C.09 Development Envelope Guidelines.
- f) The amenity of the surrounding buildings, lanes and public spaces should be protected with appropriate setbacks from the property boundaries. The set back from the rear boundary should be 6 metres, and 3 metres from the eastern service lane boundary. See Figures 9.10.4.2 to 9.10.4.10 in Control C.09 Development Envelope Guidelines.

C.09 Development Envelope Controls

- a) Future development setbacks and separations should be generally consistent with the building separation controls shown in Figure 9.10.4.2.a, 9.10.4.2.b and 9.10.4.2.c.

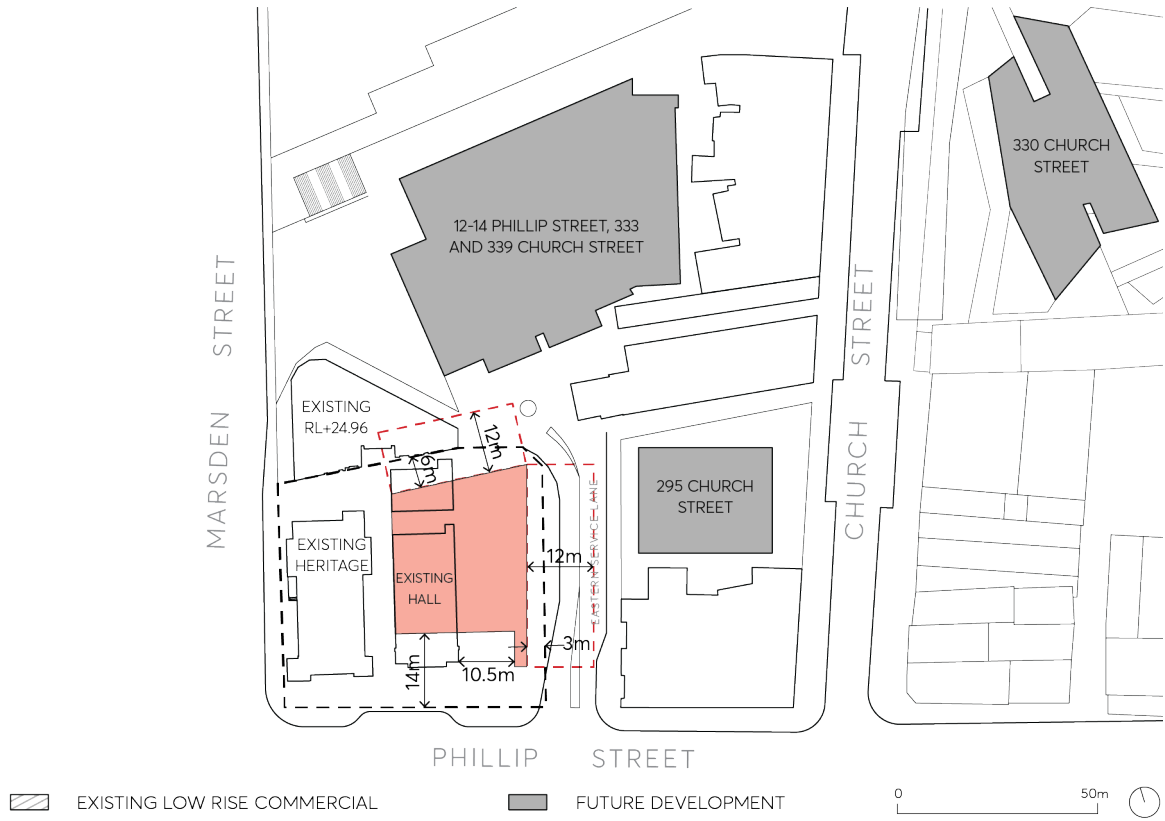

Figure 9.10.4.2.a – Setback and separations 0m - 25m (Source: Woods Bagot 2016)

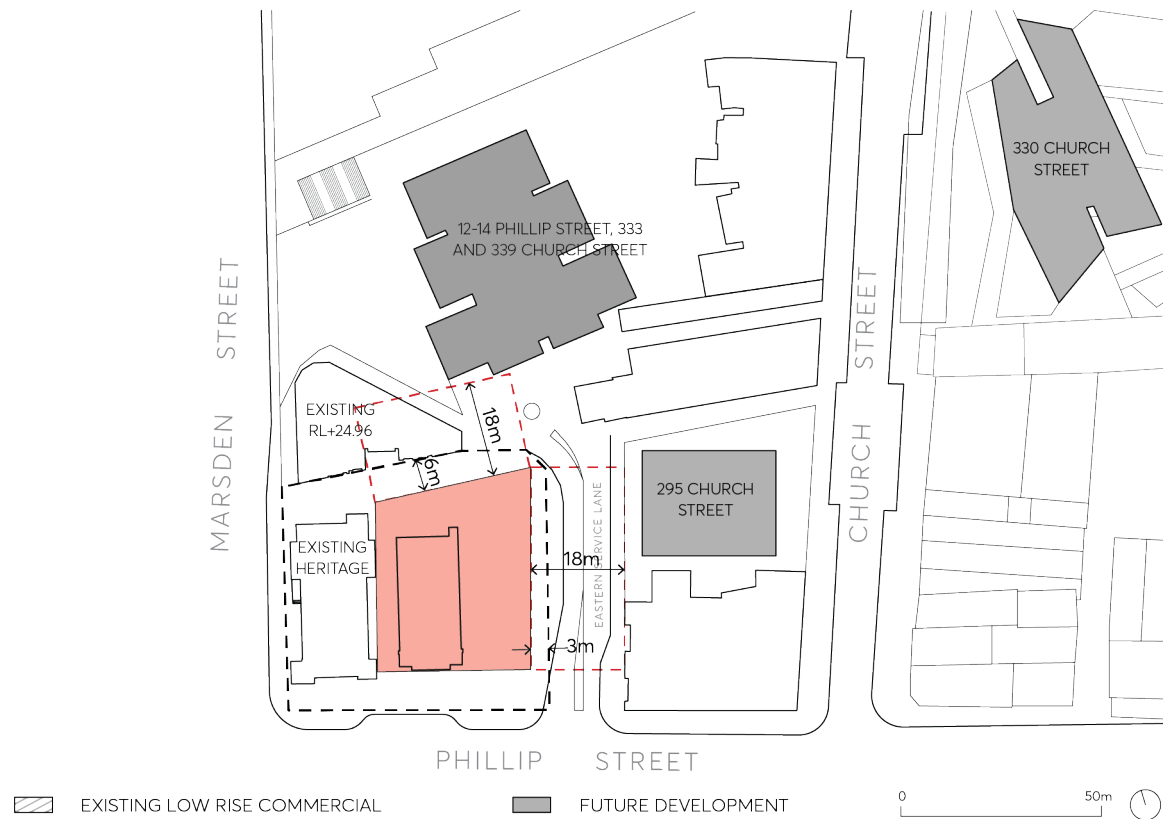

Figure 9.10.4.2.b – Setback and separations 12-25m (Source: Woods Bagot 2016)

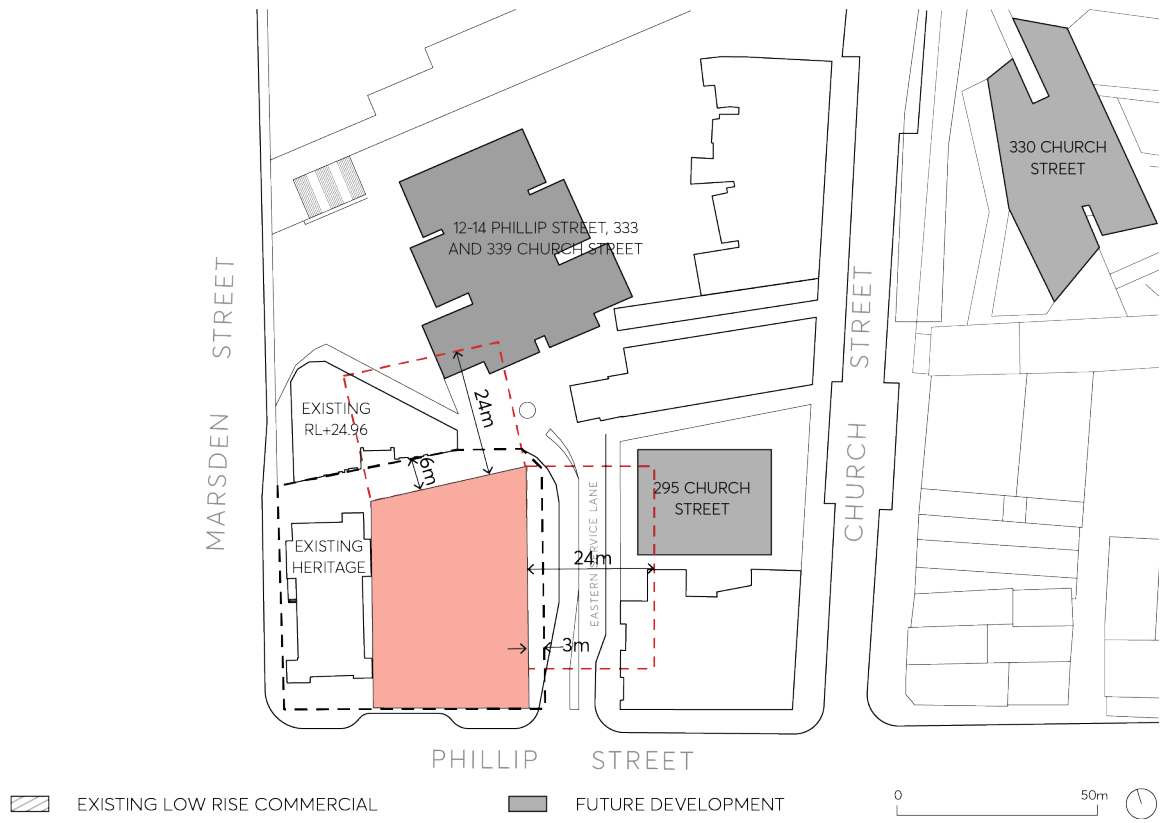

Figure 9.10.4.2.c – Setback and separations over 25m (Source: Woods Bagot 2016)

- b) The built form should be generally consistent with the building envelopes shown in Figure 9.10.4.3 to Figure 9.10.4.10.

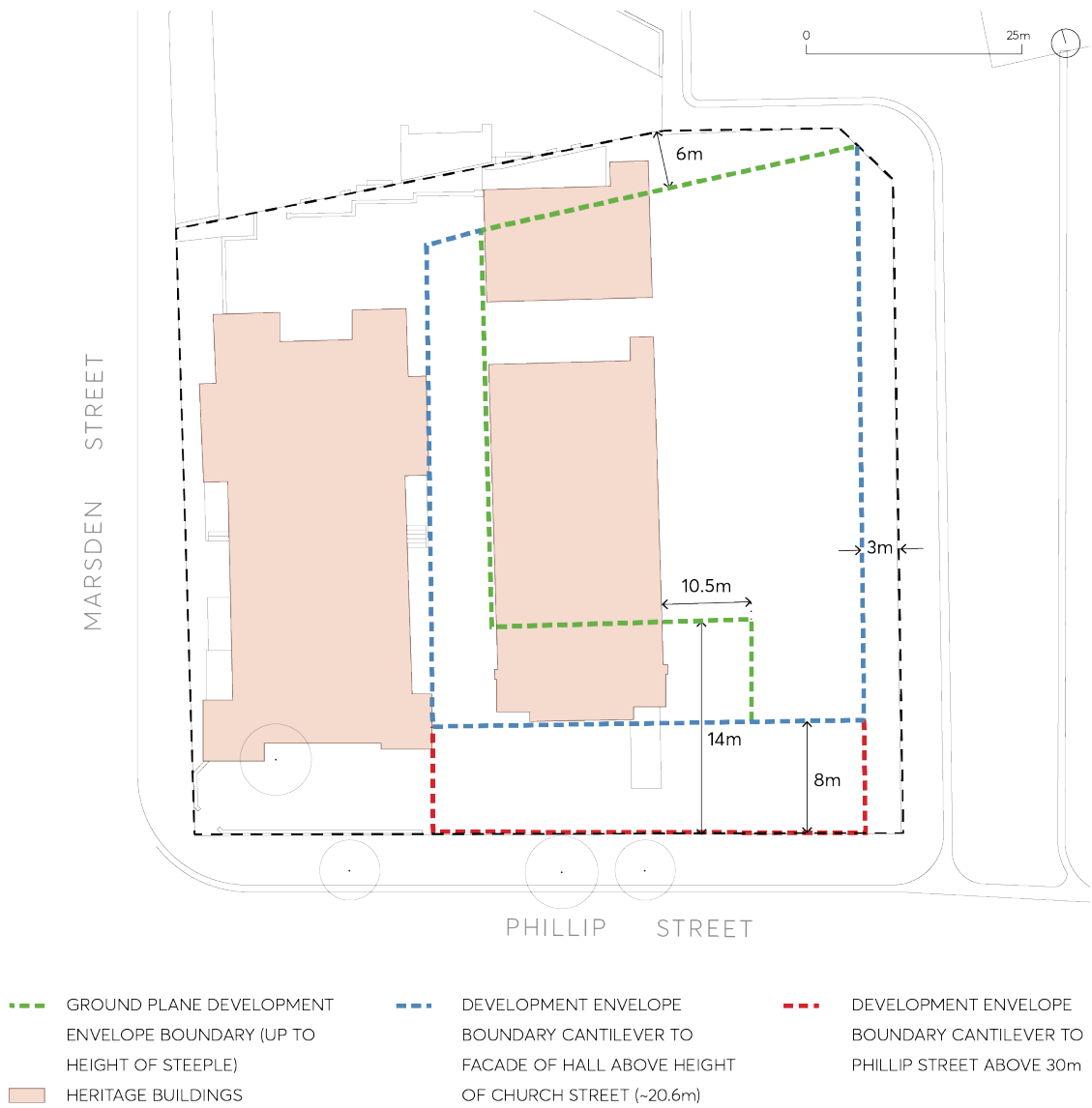

Figure 9.10.4.3 – Existing ground floor plans with building guidelines (Source: TKD Architects)

STREET VIEW FROM PHILLIP STREET (VIEWING NORTH)

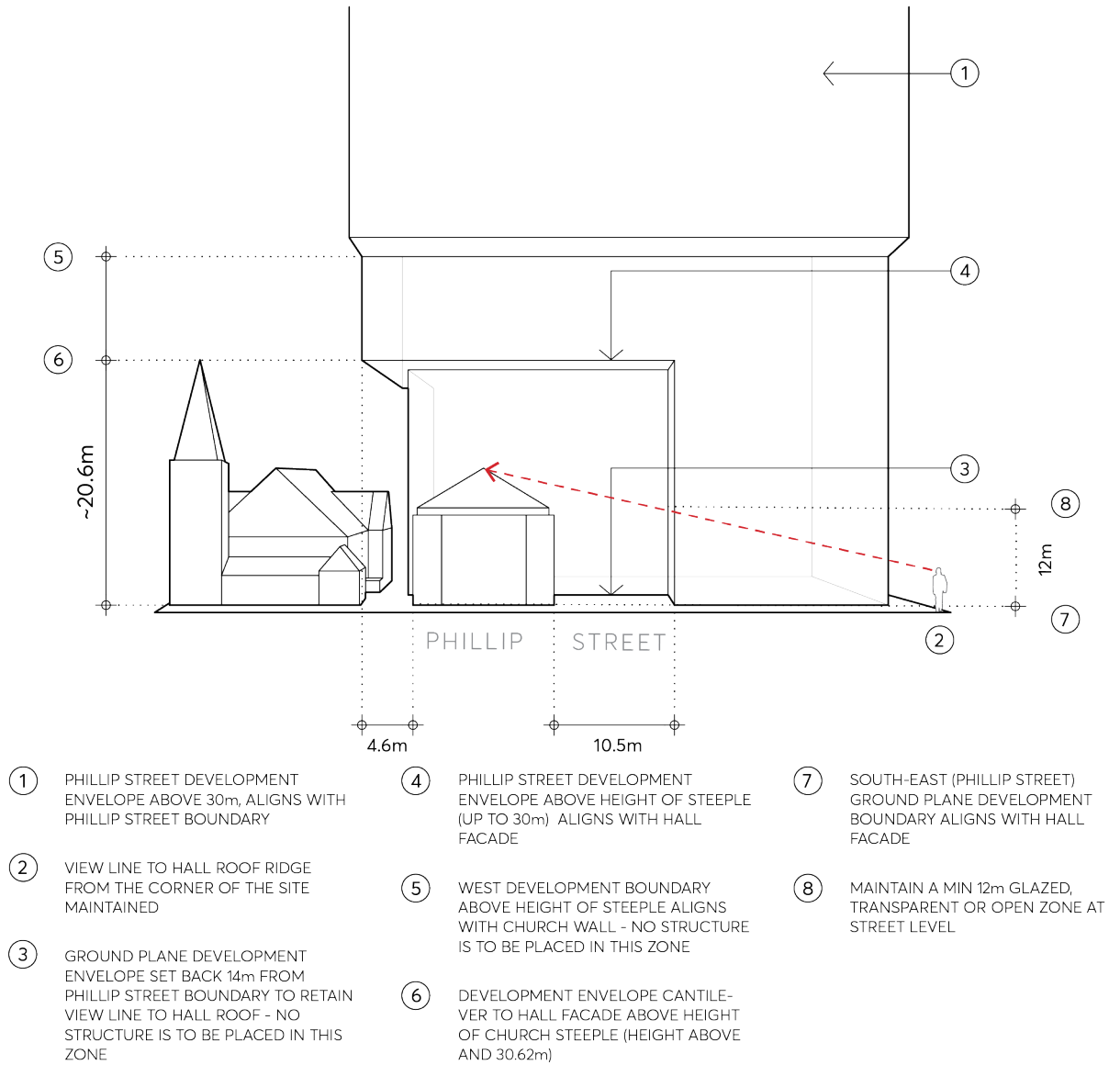

Figure 9.10.4.4 – Maximum building envelope – Ground plane from Phillip Street NTS (Source: TKD Architects)

STREET VIEW FROM MARDEN STREET (VIEWING EAST)

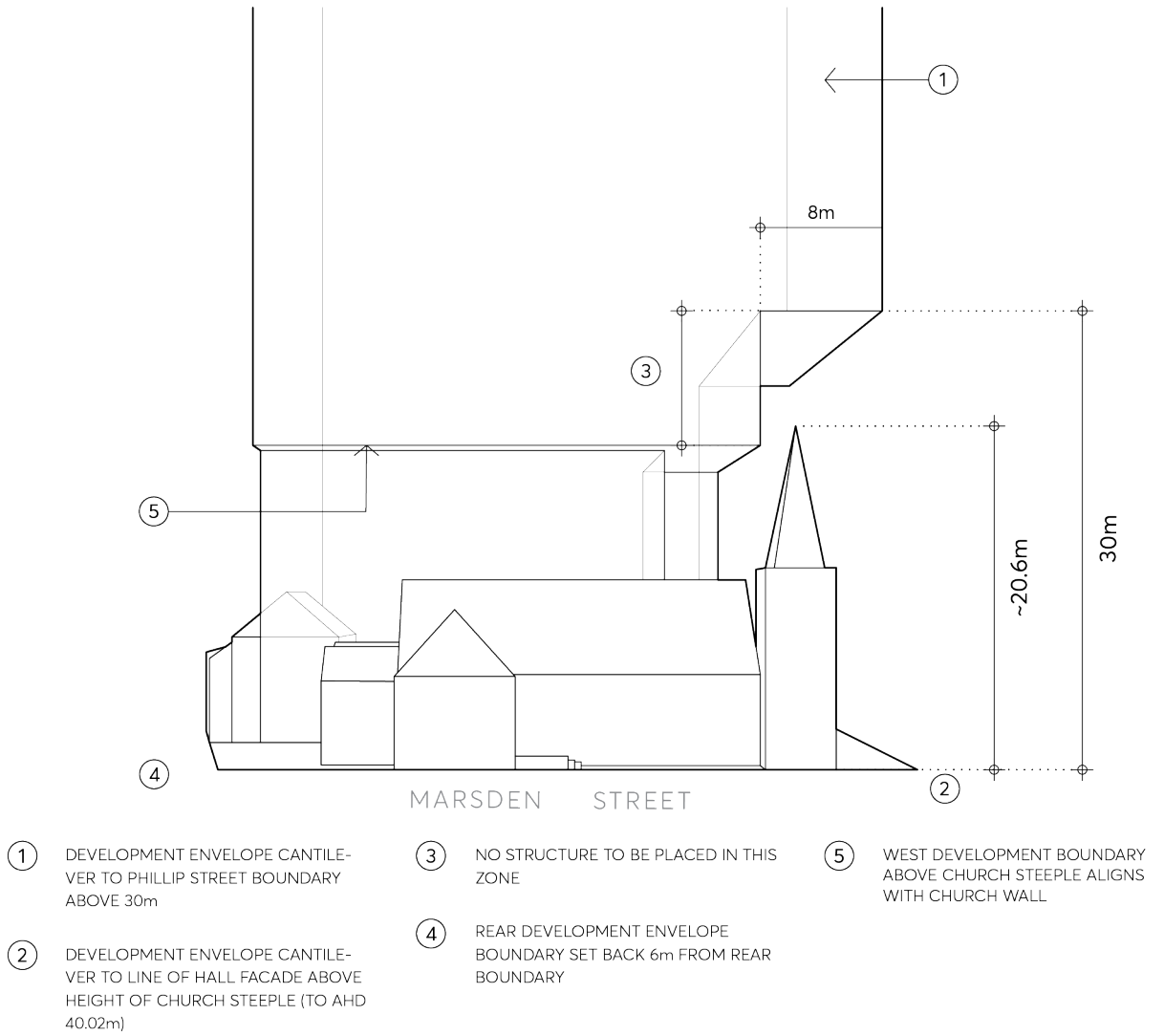

Figure 9.10.4.5 – Maximum building envelope – Ground plane from Marsden Street NTS (Source: TKD Architects)

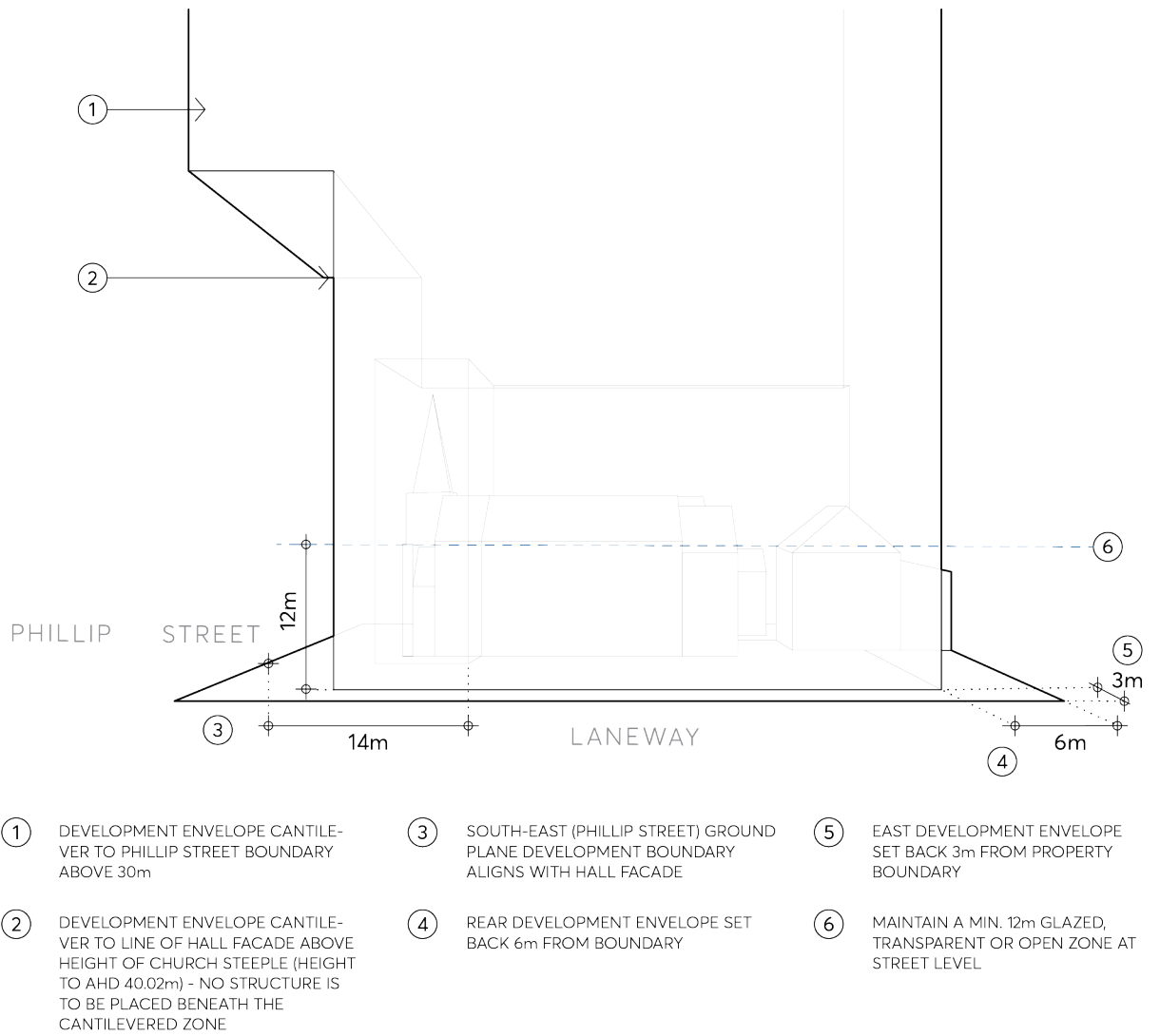
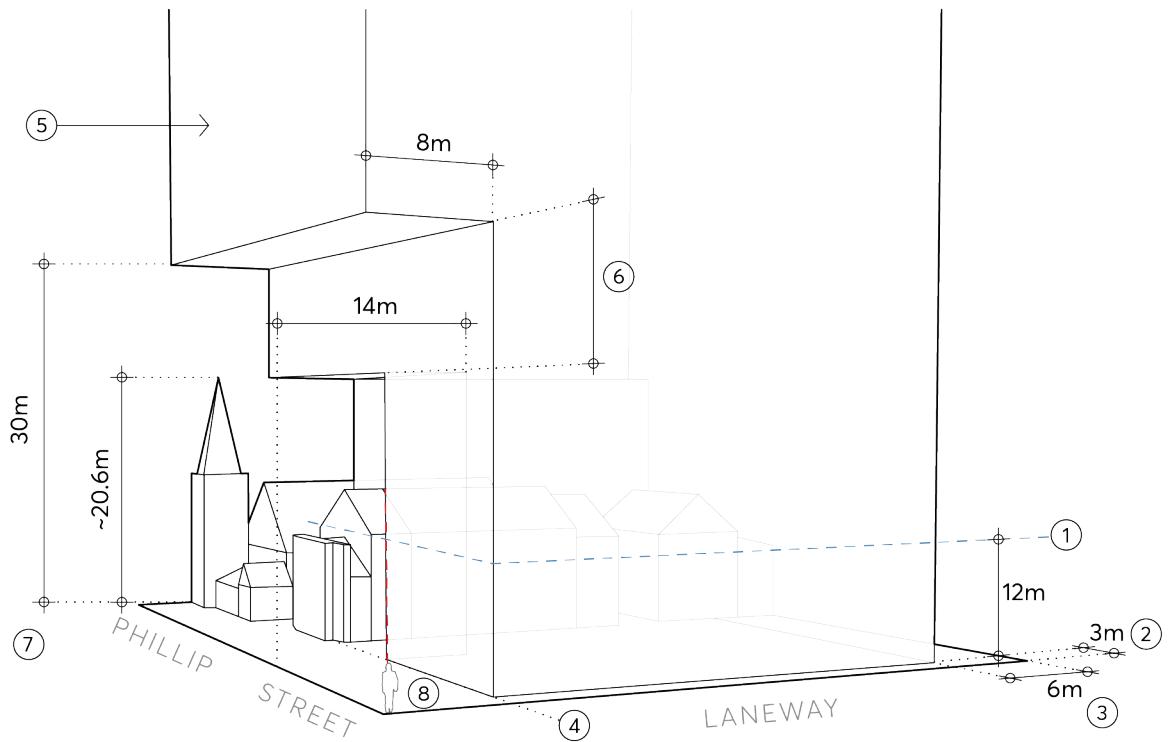

Figure 9.10.4.6 – Maximum building envelope – Ground plane view from laneway (viewing west)
 (Source: TKD Architects)



- ① MAINTAIN A MIN. 12m GLAZED, TRANSPARENT OR OPEN ZONE AT STREET LEVEL

② EAST DEVELOPMENT ENVELOPE SET BACK 3m FROM PROPERTY BOUNDARY

③ REAR DEVELOPMENT ENVELOPE SET BACK 6m FROM BOUNDARY
- ④ SOUTH-EAST (PHILLIP STREET) GROUND PLANE DEVELOPMENT BOUNDARY ALIGNS WITH HALL FACADE

⑤ DEVELOPMENT ENVELOPE CANTILEVER TO PHILLIP ST BOUNDARY ABOVE 30m

⑥ NO STRUCTURE TO BE PLACED IN THIS ZONE
- ⑦ DEVELOPMENT ENVELOPE CANTILEVER TO LINE OF HALL FACADE ABOVE HEIGHT OF CHURCH STEEPLE (TO AHD 40.02m)

⑧ VIEW LINE TO HALL ROOF RIDGE FROM THE CORNER OF THE SITE MAINTAINED

Figure 9.10.4.7 – Maximum building envelope – Ground plane from corner Phillip Street and laneway (viewing north west) NTS (Source: TKD Architects)

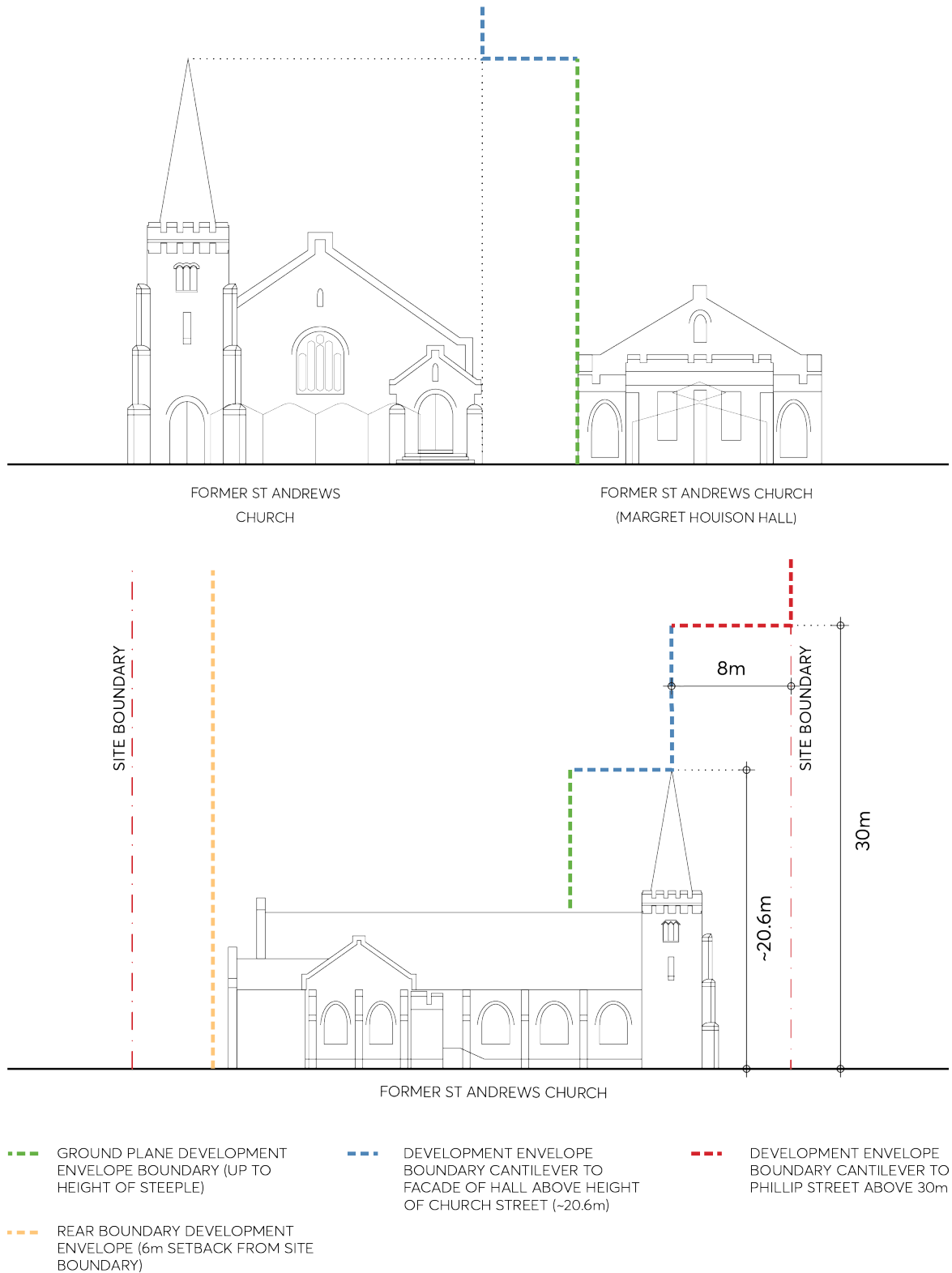
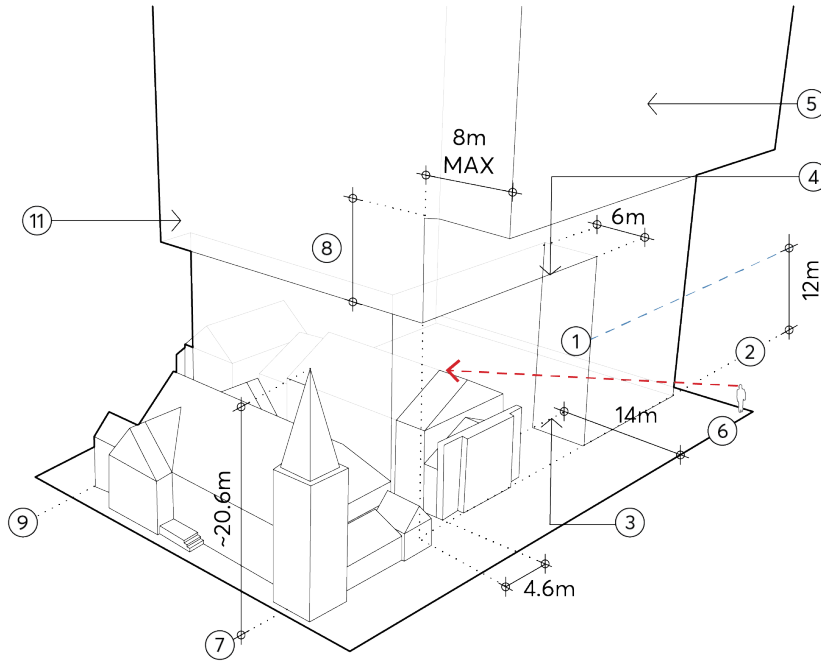
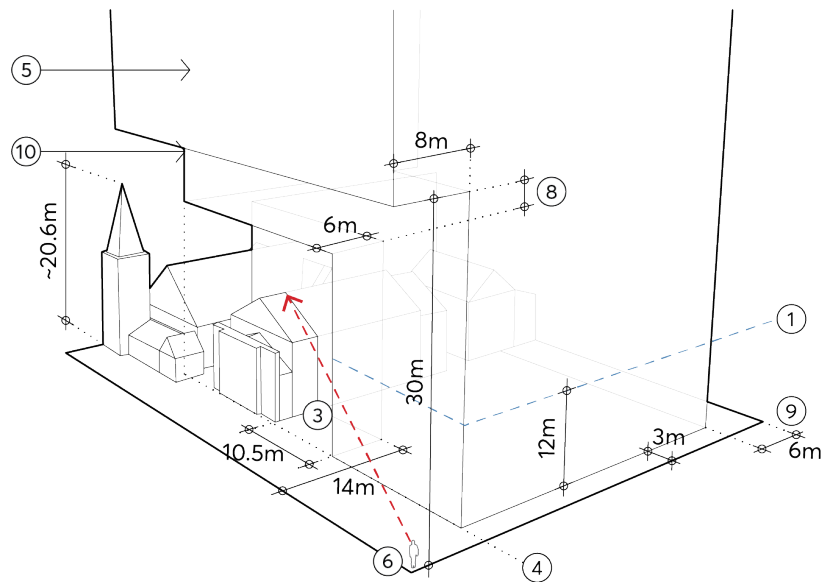

Figure 9.10.4.8 – Existing elevations with new building guidelines (Source: TKD Architects with base drawing from Paul Davies)

AERIAL SOUTH-WEST CORNER



AERIAL SOUTH-EAST CORNER



- | | | |
|--|---|--|
| <p>① MAINTAIN A MIN. 12m GLAZED, TRANSPARENT OR OPEN ZONE AT STREET LEVEL</p> <p>② SOUTH-EAST (PHILLIP STREET) GROUND PLANE DEVELOPMENT BOUNDARY ALIGNS WITH HALL FACADE</p> <p>③ GROUND PLANE DEVELOPMENT ENVELOPE SET BACK 14m FROM PHILLIP STREET BOUNDARY TO PRESERVE VIEWS OF HALL ROOF - NO STRUCTURE IS TO BE PLACED IN THIS ZONE</p> | <p>④ SOUTH (PHILLIP STREET) DEVELOPMENT ENVELOPE CANTILEVER ABOVE HEIGHT OF CHURCH STEEP ALIGNS WITH HALL FACADE</p> <p>⑤ DEVELOPMENT ENVELOPE CANTILEVER TO PHILLIP STREET BOUNDARY ABOVE 30m</p> <p>⑥ VIEW LINE TO HALL ROOF RIDGE FROM THE CORNER OF THE SITE MAINTAINED</p> <p>⑦ DEVELOPMENT BOUNDARY CANTILEVER 14m FROM BOUNDARY ABOVE HEIGHT OF CHURCH STEEPLE (HEIGHT ABOVE AHD 30.62m)</p> | <p>⑧ NO STRUCTURE IS TO BE PLACED IN THIS ZONE</p> <p>⑨ REAR DEVELOPMENT ENVELOPE SET BACK 6m FROM REAR BOUNDARY</p> <p>⑩ DEVELOPMENT ENVELOPE CANTILEVER TO ALIGN WITH HALL FACADE ABOVE HEIGHT OF CHURCH STEEPLE (HEIGHT ABOVE AHD 30.62m)</p> <p>⑪ WEST DEVELOPMENT BOUNDARY ABOVE HEIGHT OF CHURCH STEEPLE ALIGNS WITH CHURCH HALL</p> |
|--|---|--|

Figure 9.10.4.9 – Maximum building envelope – Ground plane, south west and south east corner elevations NTS (Source: TKD Architects)

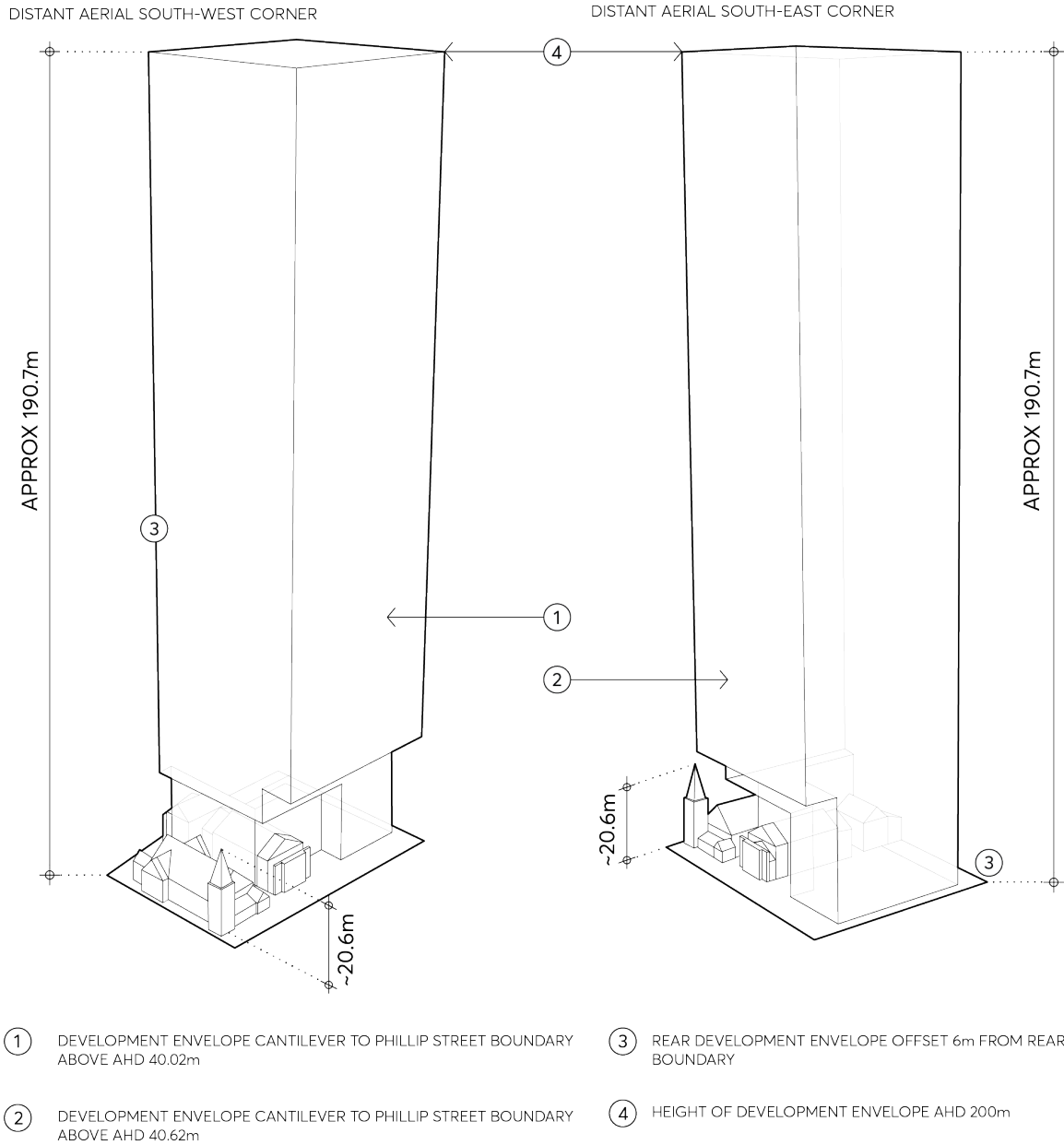

Figure 9.10.4.10 – Maximum building envelope south west and south east corner elevations (Source: TKD Architects)

9.10.5 184-188 GEORGE STREET

This Section applies to land at 184-188 George Street, Parramatta. The site comprises three allotments of land between George Street and the Parramatta River foreshore reserve as shown in Figure 9.10.5.



Figure 9.10.5 – Land application map

This Section is to be read in conjunction with other sections of this DCP as well as *Parramatta LEP 2023*. If there is any inconsistency between this Section and other sections of the DCP, this Section prevails.

9.10.5.1 DESIRED FUTURE CHARACTER

Redevelopment of the site provides an appropriate relationship to the state significant heritage item known as 'Harrisford' to the west of the site. The future built form maximises the curtilage to 'Harrisford' and ensures that 'Harrisford' remains prominent in the George Street streetscape. Both podium and tower setbacks to 'Harrisford' are maximised to achieve this outcome as well as suitable setbacks to George Street.

A through site link adjacent the site's western boundary, provides a midblock connection between George Street and Parramatta River and creates an additional public interface to 'Harrisford'.

Future development provides an appropriate interface to the public domain along both George Street and Parramatta River. High quality articulated facades are provided on all elevations which give public domain interfaces to the street, the River foreshore, the through site link and any future building from the north-eastern and eastern approach into Parramatta City Centre from Gasworks Bridge.

Future redevelopment provides an appropriate connection and transition to any future public promenade along the Parramatta River foreshore and enhances connection to the Parramatta Ferry Terminal.

Overshadowing impacts of any future development on the site on public open spaces including the Robin Thomas Reserve and James Ruse Reserve are minimised.

An appropriate design response is provided to address the flood affectation of the land. Existing stormwater drainage through the site is appropriately relocated.

Site Objectives

- O.01 To create a mixed use building with setbacks and articulation that are compatible with maintaining a strong streetscape presence for the adjoining heritage item 'Harrisford'.
- O.02 To maximise the opportunities to expand the curtilage of 'Harrisford'.
- O.03 To ensure the scale and proportions of the future building elements on the site are compatible with 'Harrisford'.
- O.04 To provide a high quality built form as viewed from all elevations and recognising the potential prominence of the building from the public domain and the north-eastern gateway into the Parramatta City Centre.
- O.05 To provide public domain elements including a pedestrian through site link, forecourt to the George Street frontage, and connection to a future public promenade along the Parramatta River foreshore.
- O.06 To provide active ground floor uses to increase pedestrian activity and promote casual surveillance along George Street, Parramatta River foreshore and the through site link.
- O.07 To minimise overshadowing impacts on public open spaces including Robin Thomas Reserve and James Ruse Reserve.
- O.08 To appropriately address the level of flood affectation on the site and to manage stormwater flows between George Street and the foreshore reserve.

Controls

Public Domain

- C.01 A new pedestrian through site link (link) is to be provided adjacent to the western side boundary of the site linking George Street and the Parramatta River foreshore. The link is to have a minimum width of 6 metres at its interface with Harrisford House and gradually reduce to a minimum of 5 metres as per Figure 9.10.6.2. Any increase in the width of the ground level setback could be considered as part of any future architectural design excellence competition and subsequent development application.

- C.02 The pedestrian link is to provide public access 24 hours per day, 7 days per week and may be the subject of land dedication to Council or an easement.
- C.03 The pedestrian through site link is to be the subject of a Public Domain Plan and Alignment Plan and consistent with [Parramatta Public Domain Guidelines](#) (City Centres Lanes) and with the objectives of the [Parramatta Laneways Policy](#). Finished treatment of the laneway should provide a high quality finish and incorporate pedestrian level lighting.
- C.04 Future development should comply with the River Foreshore controls.
- C.05 The finished levels of any future building and through site link are to provide an appropriate connection to the finished levels of 'Harrisford' and any future public promenade built along the Parramatta River foreshore edge. Careful consideration should also be given to flood planning requirements. The intent is to provide access that is as seamless as possible between all activated spaces and public domain areas.
- C.06 The setback area/public forecourt to George Street is to be appropriately treated and activated.
- C.07 Continuous active frontages are to include retail and commercial uses along the George Street frontage, the through site link and the interface with the Parramatta River foreshore reserve.

Heritage

- C.08 Future development should maximise podium and tower setbacks to 'Harrisford'. Minimum setbacks are detailed in Figures 9.10.5.2 to 9.10.5.3 below. However any opportunity to increase both the podium and tower setbacks as they relate to 'Harrisford' could be considered as part of any future architectural design excellence competition and subsequent development application.
- C.09 Building setbacks to George Street should maximise the prominence of 'Harrisford' in the George Street streetscape. Minimum setbacks are shown in Figures 9.10.5.2 to 9.10.5.3 below.
- C.10 Requirements of the NSW Office of Environment and Heritage are to be addressed with respect to both Aboriginal and Archaeological heritage significance of the site.
- C.11 Façade treatment and exterior finishes palette is to be approved by Council to ensure a suitable relationship to 'Harrisford'.

Building Form

Apartment Design

- C.12 Future built form shall comply with the requirements of *State Environmental Planning Policy No 65 – Design Quality of Residential Apartment Development 2002* (SEPP 65) and the Apartment Design Guide prepared by the NSW Department of Planning.

Building setbacks

- C.13 Future built form should be consistent with the minimum building setbacks shown in Figures 9.10.5.2 and 9.10.5.3. Opportunity to increase the width of the through site link and the podium and tower setbacks as they relate to 'Harrisford' could be considered as part of any future architectural design excellence competition and subsequent development application.



Figure 9.10.5.2 – Setbacks for ground floor



Figure 9.10.5.3 – Setbacks for tower and podium

Scale of Podium

- C.14 The podium height to George Street is to be two (2) to three (3) storeys in height. Should a third storey be proposed, exterior finishes and architectural treatments are to be applied to the George Street façade of the podium to give the appearance of two storeys to match the proportions of the Harrisford façade.
- C.15 The podium height to the foreshore boundary is to be a maximum of three (3) to four (4) storeys in height. Development should achieve an appropriate pedestrian scale adjacent to any future public domain promenade.

Floor Plate

- C.16 The tower component is to have a maximum floor plate of 900m² and is to include external walls and balconies.

Wind Mitigation

- C.17 Future development should comply with Building Form and Wind Mitigation in PDCP 2023 and also have regard to the potential wind impact on any through site link.

Overshadowing Impacts

- C.18 Development should seek to minimise the overshadowing impact of future development on public open spaces including Robin Thomas Reserve and James Ruse Reserve.

Flooding and Stormwater Management

- C.19 Future development of the site is to meet the flooding controls contained within *Parramatta LEP 2023*, this DCP and the Lower Parramatta River Floodplain Risk Management Plan (and other relevant legislation and/or guidelines). Also refer to any future flood planning controls relating to the City Centre arising from the City Centre Planning Framework.
- C.20 Future redevelopment of the site may be required to relocate the existing Council owned stormwater drainage line, which traverses the site, to Council's satisfaction. Should the stormwater drainage line be required to be located, a new easement for drainage and overland flow path adjacent to the eastern side boundary is to be provided to meet this requirement. The relocated stormwater drainage line system will need to be designed to have a 1 in 20 year ARI design capacity. The overland flow path is to be designed to enable the 1 in 100 year overland flows to be safely conveyed.
- C.21 Car parking on the site associated with future redevelopment is to address Council's flooding concerns.
- C.22 The lower ground level must relate to the river foreshore and not present blank walls inaccessible undercroft areas as a result of the flood condition.

Vehicular Access

- C.23 A combined vehicle entry/exit crossing is to be located in the south-east corner of the site with direct access to George Street. The finished levels and the location of the driveway are to be compatible with the engineering design requirements for an overland flow path and easement for drainage adjacent to the eastern side boundary.

9.10.6 2-6 HASSALL STREET, PARRAMATTA

This Section applies to 2-6 Hassall Street, Parramatta which comprises three allotments with a single frontage to Hassall Street as shown in Figure 9.10.6.



Figure 9.10.6 – Land application map

This Section is to be read in conjunction with other Sections of Parramatta DCP 2023 and the relevant provisions in *Parramatta LEP 2023*. If there is any inconsistency between this Section and other parts of the DCP, this Section prevails.

This Section establishes objectives and controls to be interpreted during preparation and assessment of development applications and supports the objectives of the relevant provisions in *Parramatta LEP 2023*.

9.10.6.1 DESIRED FUTURE CHARACTER

The redevelopment of the site into a premium-grade commercial building will contribute to the revitalisation of Hassall Street and will reinforce the character of the Parramatta City Centre as a centre for employment, business, and education.

The location of the site is within walking distance of the Parramatta Transport Interchange, providing significant employment opportunities and high levels of accessibility to future workers, in proximity to key services such as retail, entertainment and recreational facilities. The redevelopment of the site is intended to support the Parramatta City Centre in its role as a Sydney's Central City Centre and is to respond to the site's unique setting and heritage context including the adjoining Lancer Barracks and Commercial Hotel.

The development requires a design response which is sensitive to the adjoining heritage context whilst responding to the future envisaged scale of the City Centre. The redevelopment of the site is required to establish an active street frontage to Hassall Street and encourage a high level of connectivity through the site.

Future redevelopment is to make provision for a through site link from Hassall Street to the Lancer Barracks, allowing potential future connectivity. The provision of a public access link will ensure a continuous public connection to the civic heart of the City Centre and increase pedestrian access to the surrounding street network.

Site Objectives

- O.01 Provide controls and a built form outcome consistent with the envisaged scale of the Parramatta City Centre.
- O.02 Increase high grade commercial floorspace on the site to strengthen Parramatta as Sydney's central City Centre.
- O.03 Protect heritage values of the locality by ensuring compatible design and setbacks and providing heritage through links to Lancer Barracks.
- O.04 Facilitate higher density development on a strategic site in immediate proximity to the Parramatta Rail Station based on the principles of transit-oriented development.
- O.05 To improve ground plane amenity along Hassall Street.

9.10.6.2 BUILDING FORM

The development provisions on building form in this section are intended to encourage high quality design for new buildings, balancing the character of Parramatta with innovation and creativity. The resulting built form and character of new development should contribute to an attractive public domain in central Parramatta and produce a desirable setting for its intended uses.

Objectives

- O.01 To establish high quality architectural and urban design for buildings.
- O.02 Provide a building envelope that is capable of achieving design excellence and a high performing building on a central City Centre site.
- O.03 Design buildings with a high level of environmental performance to encourage comfort and full occupation.

- O.04 To provide appropriate articulation of building form that is responsive to street address, microclimate and pedestrian-orientated environment.
- O.05 Development should be responsive to the unique scale and character of the heritage buildings around the precinct.
- O.06 Development should maintain a consistent street wall alignment on the northern edge of Hassall Street.
- O.07 Maintain adequate inter-tower separation from the NSW Police Headquarters building to the north-east.

Controls

C.01 Street Wall and Building Height

- a) Figure 9.10.6.2 and Figure 9.10.6.3 illustrate the maximum permitted podium and tower heights for the development, including:
- A maximum street wall height of 3 storeys, to align with the parapet of the Commercial Hotel to the east.
 - Above the podium, a 19 storey tower

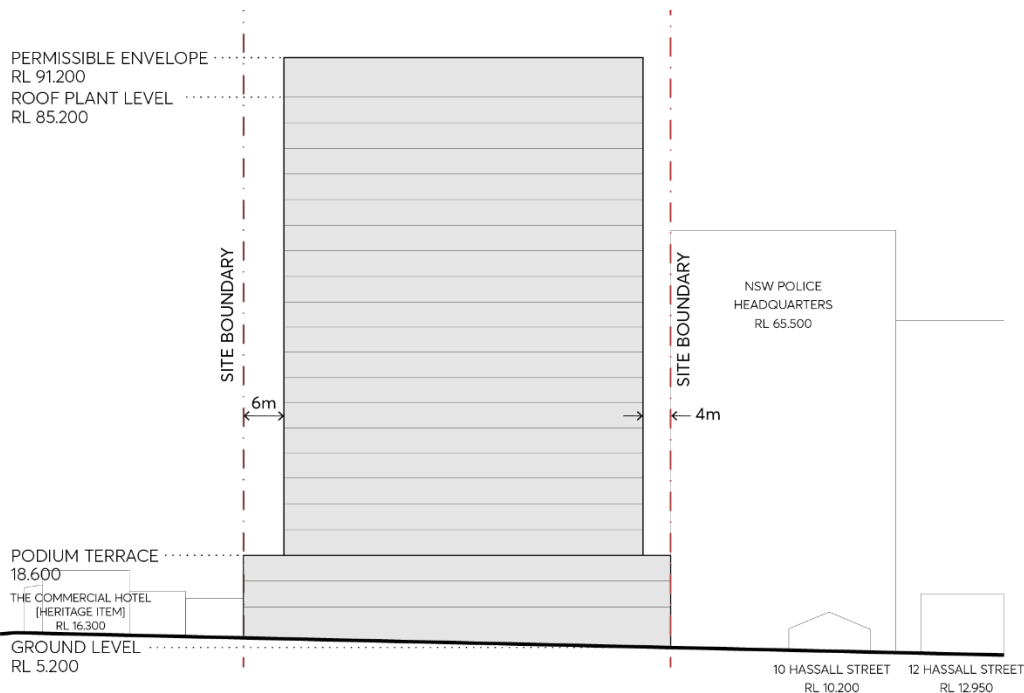

Figure 9.10.6.2 – Hassall Street (southern) elevation illustrating the maximum building envelope

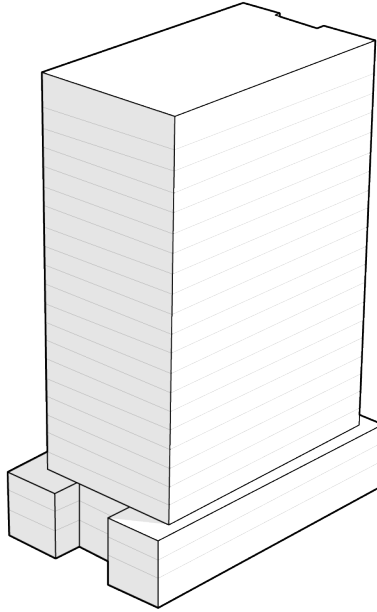

Figure 9.10.6.3 – Maximum Building Envelope (Isometric view)

C.02 Building Setbacks and Envelope

- a) Future development setbacks should be consistent with the building setback controls shown in Figure 9.10.6.4.
- b) Provide a 3 metre podium setback from Lancer Barracks to the north, and a 2 metre podium setback to the southern boundary (Hassall Street) to match the predominant street boundary alignment to the east and aligning with the ground level façade.
- c) Provide zero setbacks to the east and west boundary for the podium.
- d) Above the podium, the minimum tower setbacks are to be:
 - 3 metres from the edge of the podium to the north (6 metres to the northern boundary)
 - 3 metres from the east boundary (and podium edge)
 - 6 metres to Hassall Street (4 metres from the edge of the podium to the south)
 - 6 metres from the west boundary (and podium edge)

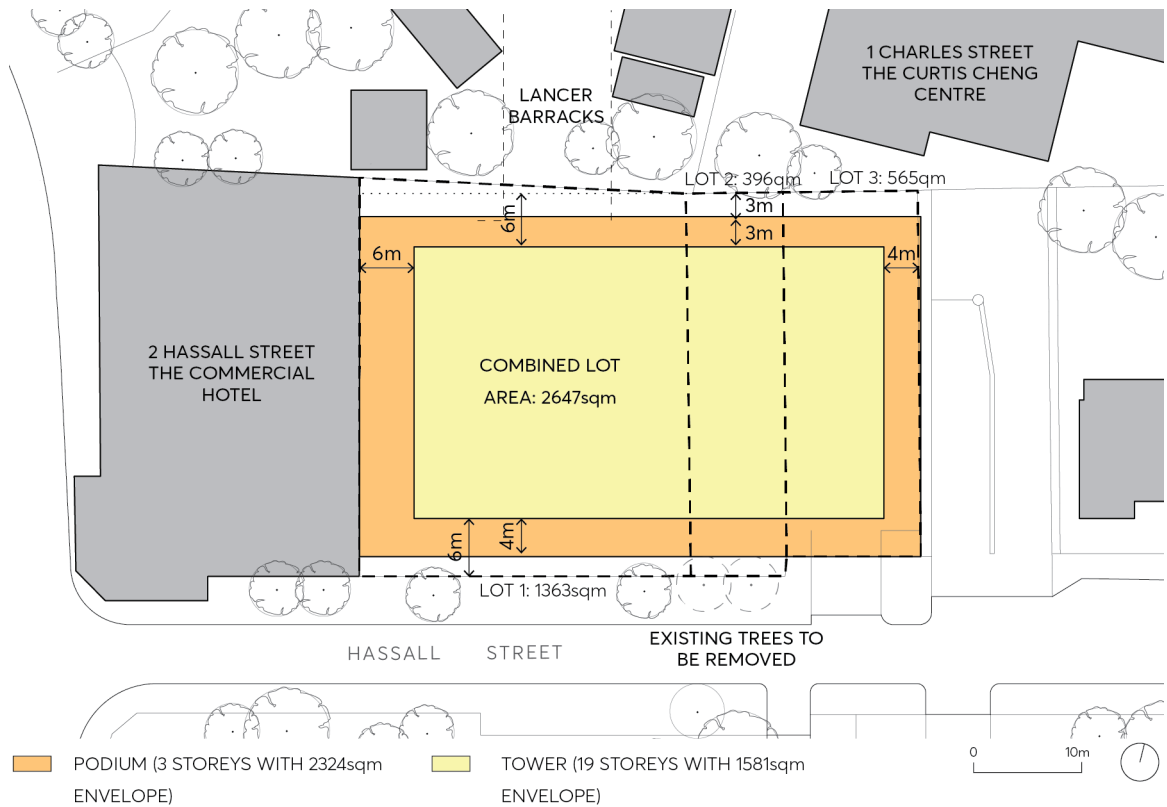

Figure 9.10.6.4 – Building setback control

C.03 Street Activation and Through Site Link

- a) A high level of permeability through and around the site is to be achieved.
- b) Ground level uses should activate the street frontage to Hassall Street.
- c) A through site link should be created providing a connection between Hassall Street and the Lancer Barracks as shown in Figure 9.10.6.5 that is able to be accessed by the public (during daylight hours).

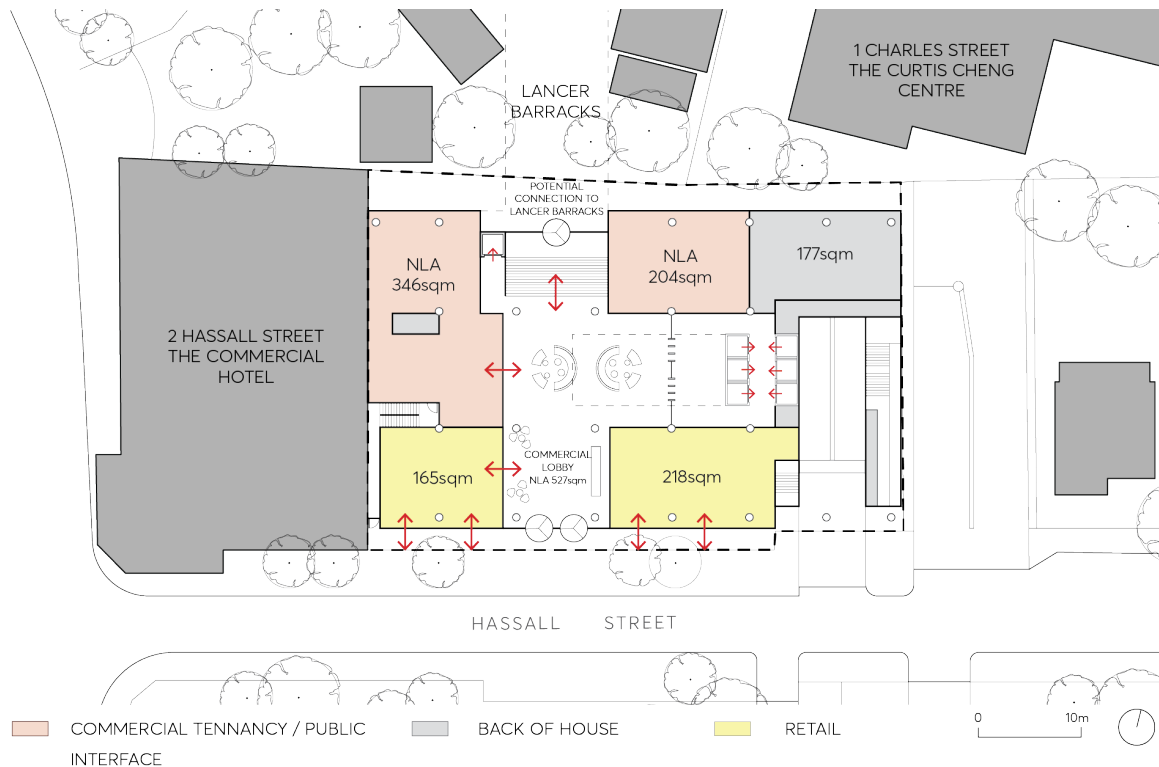

Figure 9.10.6.5 – Through Site Link (indicative sketch)

C.04 Vehicle Access and Parking

- a) Vehicular access may be from the eastern portion of the Hassall Street frontage.
- b) Development on the site is not permitted to exceed the car parking rate outlined below:

Commercial: If the **FSR > 3.5:1**, **M = (G x A) / (50 x T)**, where:

M = maximum number of parking spaces;

G = GFA of all office/business premises in the building (m²);

A = Site Area (m²); and

T = Total GFA of all buildings on the site (m²).

C.05 Roof design

- a) The roof design may consider a staggered profile and a varying skyline in order to better articulate and modulate the built form.

C.06 Landscaping

- a) The setback on the northern boundary is to be used as a deep soil zone for new planting and tree roots protection zone for the existing tree on the adjacent site.
- b) The 2 large palm trees on Hassall Street are relocated to the deep soil zone at the northern boundary.

9.10.7 12A PARKES STREET

This Section applies to 12A Parkes Street, Harris Park (also known as 122 Wigram Street, Parramatta), as labelled in Figure 9.10.7.



Figure 9.10.7 – Land application map

This Section is to be read in conjunction with other Sections of Parramatta DCP 2023 as well as the relevant provisions in *Parramatta LEP 2023*. If there is any inconsistency between this Section and other Sections of this DCP, this Section prevails.

This Section establishes objectives and controls to be interpreted during preparation and assessment of development applications and supports the objectives of the relevant provisions in *Parramatta LEP 2023*.

9.10.7.1 DESIRED FUTURE CHARACTER

Future development at 12A Parkes Street, Harris Park shall be designed to respond to the flood conditions of the site and the recommendations in the report *Independent Flood Assessment Final Report for 12A Parkes Street, Harris Park (2018)* prepared by Molino Stewart.

Site Objectives

- O.01 To facilitate redevelopment of the site as a high-quality mixed use development.
- O.02 To ensure the building interfaces positively with the public areas and contributes to an attractive public domain and desirable setting for its intended uses.
- O.03 To ensure the design of the building addresses the local flood conditions and does not impede local overland flow paths.
- O.04 To minimise the risk to life by ensuring appropriate safe areas within the building to shelter during a flood, and safe access from the building during a medical or fire emergency.
- O.05 To allow uses and development on the site that are appropriate to the flood hazard.

Controls

Building Footprints and Uses

- C.01 To maintain local flood conveyance between Parkes Street and the Clay Cliff Creek stormwater channel, development on the site must have a building footprint that is set back 9 metres from the Charles Street frontage and 1 metre from the Clay Cliff Creek stormwater channel.
- C.02 Any cantilever tower element (excluding any structural support columns or similar) must have a minimum 4 metre clearance above the ground surface level of the overland flow path throughout the site to enable a landscaped open space or 'urban room' to be created.
- C.03 The landscaped open space or urban room must:
 - create a positive and safe experience for pedestrians,
 - promote activity, connectivity and variety in the public domain,
 - be designed having regard to aspect, height and proportions, and
 - be designed at the same level as the street to facilitate step-less access and be flush with the public domain.
- C.04 Development Application submission requirements must include architectural design details for the landscaped open space or urban room that:
 - demonstrate consideration of the above requirements in C.02 and C.03,
 - have regard for [Parramatta Public Domain Guidelines](#), and
 - are to the satisfaction of the Design Excellence Jury.
- C.05 Permanent and temporary commercial or retail floor space or uses are not permitted below the 1% annual exceedance probability (AEP) flood level plus freeboard (500 mm) on any part of the site.
- C.06 The habitable floors of all residential uses within the building must be above the probable maximum flood (PMF).
- C.07 'Sensitive Uses and Facilities' and 'Critical Utilities and Uses' as defined in Table 5.1.1.1 in Section 5.1.1 – Flooding are not permitted within the building.

Building and Basement Design

- C.08 To minimise the chance of a fire during a flood situation, the building must have a fire management system which meets the Australian Building Code Board (ABCB).
- C.09 External fire doors must be located above the 1% annual exceedance probability (AEP) flood level plus freeboard (500 mm).
- C.10 To prevent flood waters from entering the basement car park, a driveway crest at or above the flood planning level (1% AEP flood level plus 500 mm freeboard) including associated bund walls must be provided. Above this, at or near the crest of the driveway, a passive automatic flood barrier up to the probable maximum flood (PMF) must be installed. Flood doors and other measures must also be provided to ensure flood waters up to the PMF cannot enter the basements.
- C.11 Wherever possible, critical services infrastructure that could be damaged by flooding such as electrical, lift, sewer and water are to be placed above the PMF level, or, where that cannot reasonably be achieved, effectively flood-proofed.
- C.12 Development Application submission requirements must:
- a) demonstrate that the building and basement will be protected from floodwaters up to the PMF, and
 - b) include evidence demonstrating why all or some of the critical infrastructure services cannot be located above the PMF and the floodproofing measures to be taken instead.

Areas of Refuge and Evacuation Routes

- C.13 All building occupants (residents, workers and visitors) must have access to a safe area of refuge above the PMF where they can remain until the flood event has passed and any subsequent disruption after the flood has been rendered safe and serviceable. A safe area of refuge can be within a resident's own apartment, and or a communal area for workers, residents, and visitors.
- C.14 A communal safe area of refuge must have:
- emergency electricity, clean water, food, ablutions and medical equipment including a first aid kit.
- C.15 All safe areas of refuge (resident's own apartment or a communal area) must have:
- a) fail-safe access from anywhere in the building (elevator access is not allowed) that is protected from floodwaters up to the PMF by suitable flood doors, flood gates and the like, and
 - b) fail-safe access to an exit/entry point located above the 1% AEP flood level plus 0.5m freeboard that enables people to exit the building during a fire and/or flood, and allows emergency service personnel to enter a building to attend to a medical emergency.
- C.16 The buildings exit/entry points located above the 1% AEP flood level plus 0.5 m freeboard, must enable a safe route above the 1% AEP from the site to a flood free location above the PMF.
- C.17 Development Application submission requirements must include a Flood Emergency Response Plan (FERP) consistent with the FERP for the City Centre. The FERP must outline:
- a) both warning and evacuation measures for occupants in the building including the most appropriate 'safe areas' and 'safe evacuation routes';

- b) measures to prevent evacuation from the site by private vehicle;
- c) the most appropriate emergency response for flood and fire events that occur together;
- d) a building flood emergency response plan, similar to a building fire evacuation drill, and measures to ensure this is tested at least annually; and
- e) consultation undertaken with relevant state and local agencies in the preparation of the FERP.

9.10.8 14-20 PARKES STREET, HARRIS PARK

This Section applies to land at 14-20 Parkes Street, Harris Park, as shown in Figure 9.10.8.



Figure 9.10.8 – Land application map

This Section is to be read in conjunction with other Sections of Parramatta DCP 2023 and relevant provisions in *Parramatta LEP 2023*. If there is any inconsistency between this Section and other Sections of the DCP, this Section prevails.

This Section establishes objectives and controls to be interpreted during preparation and assessment of development applications and supports the objectives of the LEP.

9.10.8.1 DESIRED FUTURE CHARACTER

Future development at 14-20 Parkes Street, Harris Park is designed to respond to the flood conditions of the site.

Site Objectives

- O.01 To ensure the design of the building addresses the local flood conditions and does not impede local overland flow paths.
- O.02 To minimise the risk to life by ensuring appropriate safe areas within the building to shelter during a flood, and safe access from the building during a medical or fire emergency.
- O.03 To allow uses and development on the site that are appropriate to the flood hazard.
- O.04 To facilitate redevelopment of the site as a high-quality mixed use development.
- O.05 To ensure the building interfaces positively with the public areas and contributes to an attractive public domain and desirable setting for its intended uses.

Controls

Building Footprint and Uses

- C.01 To maintain local flood conveyance eastwards from Parkes St, Wigram Street and into the Clay Cliff Creek stormwater floodway, development on the site must have a building footprint that is setback a minimum of 6 metres from the top of the southern bank of the Clay Cliff Creek stormwater channel, and a greater amount for the north west corner of the building adjoining Wigram Street (channel wall) in accordance with Figure 9.10.8.2.



Figure 9.10.8.2 – Required floodway setbacks

- C.02 Any cantilever building element (excluding any structural support columns or similar) must have a minimum 4 metre clearance above the ground surface level of the overland flow path throughout the site to enable a landscaped open space to be created. A minimum 4.5 metre setback between the channel bank and the building must be maintained above this clearance height.
- C.03 The landscaped open space must:

- a) be designed for low intensity and low risk pedestrian activities, recognising this is a site of 'high hazard' flash flooding;
 - b) create a positive and safe experience for pedestrians;
 - c) promote activity, connectivity and variety in the public domain;
 - d) be designed having regard to aspect, height and proportions;
 - e) be designed in conjunction with street levels to facilitate step-less access; and
 - f) be provided with 'deep soil' and planted with appropriate tree and shrub species that are satisfactory to Council for this context.
- C.04 Development Application submission requirements must include architectural design details for the landscaped open space and its interface with the building that:
- a) demonstrate consideration of the above requirements in C.02 and C.03;
 - b) have regard to [Parramatta Public Domain Guidelines](#);
 - c) have regard to the City of Parramatta's Council's Best Practice Urban Design in Flood Prone Areas;
 - d) have regard to the immediate flooding environment, and
 - e) are to the satisfaction of the Design Excellence Jury.
- C.05 Permanent and temporary commercial or retail floor space or uses are not permitted below the Flood Planning Level, which is either the Council-adopted 1% AEP flood water surface level plus 0.5m freeboard, or the overland flow flood level as agreed by Council, whichever is the greater.
- C.06 The habitable floors of all residential uses within the building must be above the Probable Maximum Flood (PMF) is adopted by Council for this site.
- C.07 'Sensitive Uses and Facilities' and 'Critical Uses and Facilities,' as defined in Table 5.1.1.1 in Section 5.1 – Water Management are not permitted within the building.

Building and Basement Design

- C.08 To minimise the chance of a fire during a flood situation, the building must have a fire management system which meets the Australian Building Code Board (ABCB).
- C.09 External fire doors must be located above the Flood Planning Level.
- C.10 To prevent flood waters from entering the basement car park, a driveway crest at or above the Flood Planning Level including associated bund walls must be provided. Above this, at or near the crest of the driveway, automatic flood barriers must be installed that exclude floodwaters up to the Probable Maximum Flood (PMF). Other measures such as flood doors must also be provided at all openings to the basement to exclude flood waters up to the PMF.
- C.11 Wherever possible, critical services infrastructure that could be damaged by flooding such as electrical, lifts, sewer and water are to be placed above the PMF level, or, where that cannot reasonably be achieved, effectively flood proofed.

C.12 Development Application submission requirements must:

- a) demonstrate that the building and basement will be protected from floodwaters up to the PMF;
- b) include evidence demonstrating why all or some of the critical infrastructure services cannot be located above the PMF and the floodproofing measures to be taken instead.

Areas of Refuge and Evacuation Routes

C.13 All building occupants (residents, workers and visitors) must have access to a safe area of refuge or 'shelter in place') above the PMF where they can remain until the flood event has passed and any subsequent disruption after the flood has been rendered safe and serviceable. Residents may choose to remain in their own apartments as a safe area of refuge. A communal safe area(s) of refuge for residents, workers and visitors must also be provided and suitably equipped.

C.14 A communal safe area of refuge must have: emergency electricity supply, clean water, food, personal washing facilities, medical equipment including a first aid kit, a battery-powered radio and relevant communications equipment.

C.15 All safe areas of refuge (residents own apartment or a communal area) must have:

- a) fail safe access from anywhere in the building including the basement (lift access is not allowed) that is protected from floodwaters up to the PMF by suitable flood doors, flood gates and the like; and
- b) fail safe access to an exit/entry point located above the 1% AEP flood level plus 0.5m freeboard that enables people to exit the building during a fire and/or flood, and allows emergency service personnel to enter a building to attend to a medical emergency.

C.16 Development Application submission requirements must include a Flood Emergency Response Plan (FERP) consistent with the FERP for the City Centre. The FERP must outline:

- a) both warning and evacuation measures for occupants in the building including the most appropriate 'safe areas' and 'safe evacuation routes';
- b) measures to prevent evacuation from the site by private vehicle;
- c) the most appropriate emergency response for flood and fire events that occur together;
- d) a building flood emergency response plan, similar to a building fire evacuation drill, and measures to ensure this is tested at least annually; and
- e) consultation undertaken with relevant state and local agencies in the preparation of the FERP.

C.17 The Building Management System and Plan for the development must include all necessary measures to maintain, test and operate the flood protection devices including flood gates, doors and barriers, flood sensors, flood refuges and FERP.

9.10.9 55 AIRD STREET

This Section applies to land at 55 Aird Street, Parramatta (described as Lot 4 in DP310151) as shown in Figure 9.10.9.

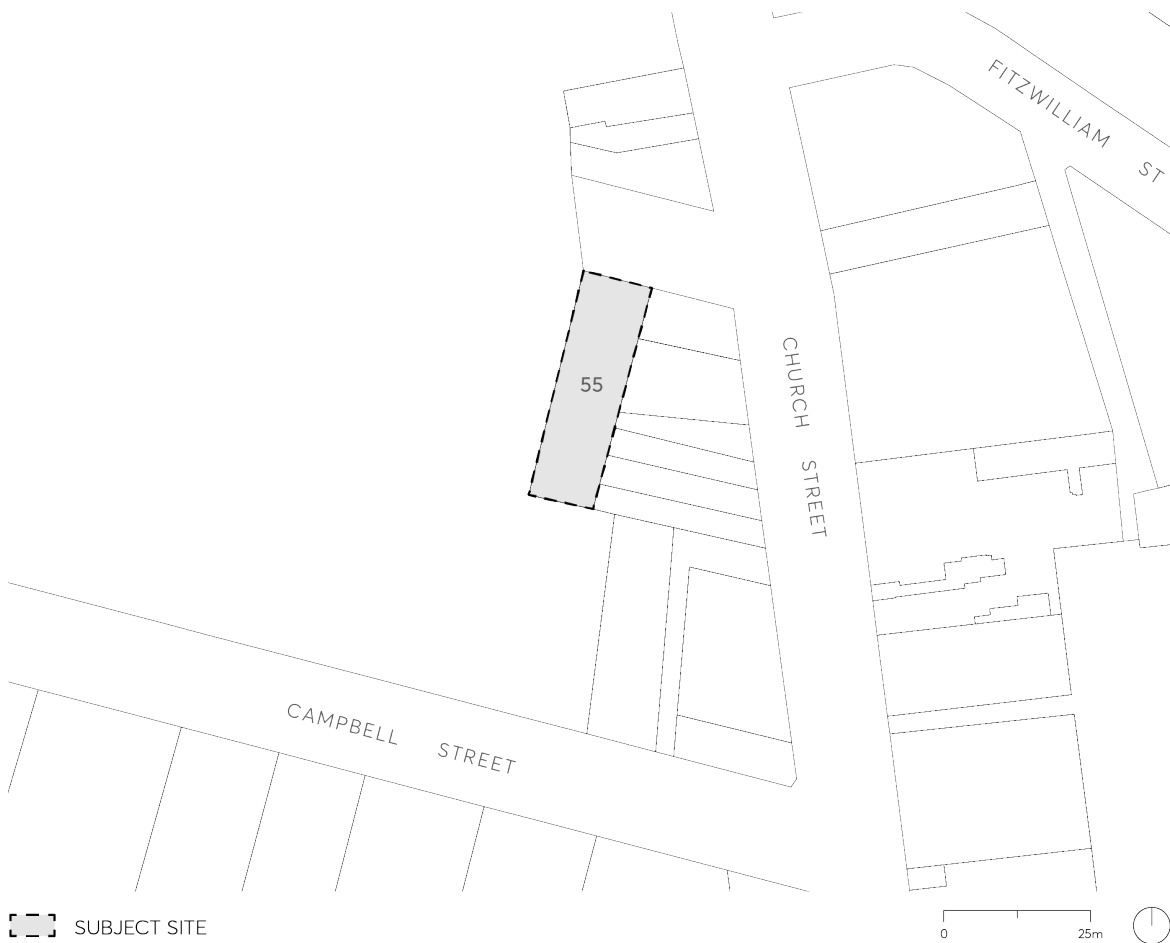

Figure 9.10.9 – Land application map

This Section is to be read in conjunction with other Sections of Parramatta DCP 2023 and the relevant provisions in *Parramatta LEP 2023*. If there is any inconsistency between this Section and other Sections of Parramatta DCP 2023, this Section prevails.

This Section establishes objectives and controls to be interpreted during preparation and assessment of development applications and supports the objectives of the relevant provisions in *Parramatta LEP 2023*.

Guiding Principles

P.01 Facilitate redevelopment of the site as a high-quality mixed use development to support the role of the Parramatta City Centre.

Contribute to the public domain at ground level through an activated edge to Aird Street.

Design the street wall to create streets that are legible, comfortable, safe, functional and attractive.

Design the street wall to respond to existing built context.

Set back buildings above the street walls to allow daylight penetration, mitigate wind impacts, and enable views to the sky in streets and public places.

Design the tower to be elegantly proportioned and maximise its slenderness of form.

Protect amenity, daylight penetration, views to the sky and privacy between adjoining developments and minimise the negative impacts of buildings on the amenity of the public domain.

Design and select the materials of buildings and the public domain to contribute to a high quality, durable, and sustainable urban environment.

9.10.9.1 BUILDING ENVELOPES

Objectives

- O.01 Reinforce the spatial definition of the streets.
- O.02 Design the street walls with an appropriate human scale and sense of enclosure for the streets.
- O.03 Protect daylight access at street level and permit views of sky from the streets by providing setbacks above street frontage height that promote separation between buildings.
- O.04 Ensure that building form achieves comfortable public domain conditions for pedestrians, with adequate daylight, appropriate scale, and mitigation of wind effects of the tower building.
- O.05 Ensure that the ground level interface provides shelter for pedestrians in the form of an awning.
- O.06 Ensure that built form achieves contextual fit with adjacent buildings on Aird and Church Streets.

Controls

- C.01 Building envelopes must be consistent with the minimum setbacks specified in Figure 9.10.9.2 if a Residential Development or Figure 9.10.9.3 if a Non-Residential Development.
- C.02 The street wall must be built to the street boundary along its full frontage on Aird Street.
- C.03 Above the street wall the recessed tower element must be set back a minimum of 3 metres from Aird St.
- C.04 Setbacks must be measured perpendicular to the boundary to the outer faces of the buildings.
- C.05 The height of the podium at Aird must relate to the existing adjacent building to the west and south.
- C.06 Any blank walls are to be designed or treated to provide a high-quality finish of visual interest.

RESIDENTIAL SCHEME

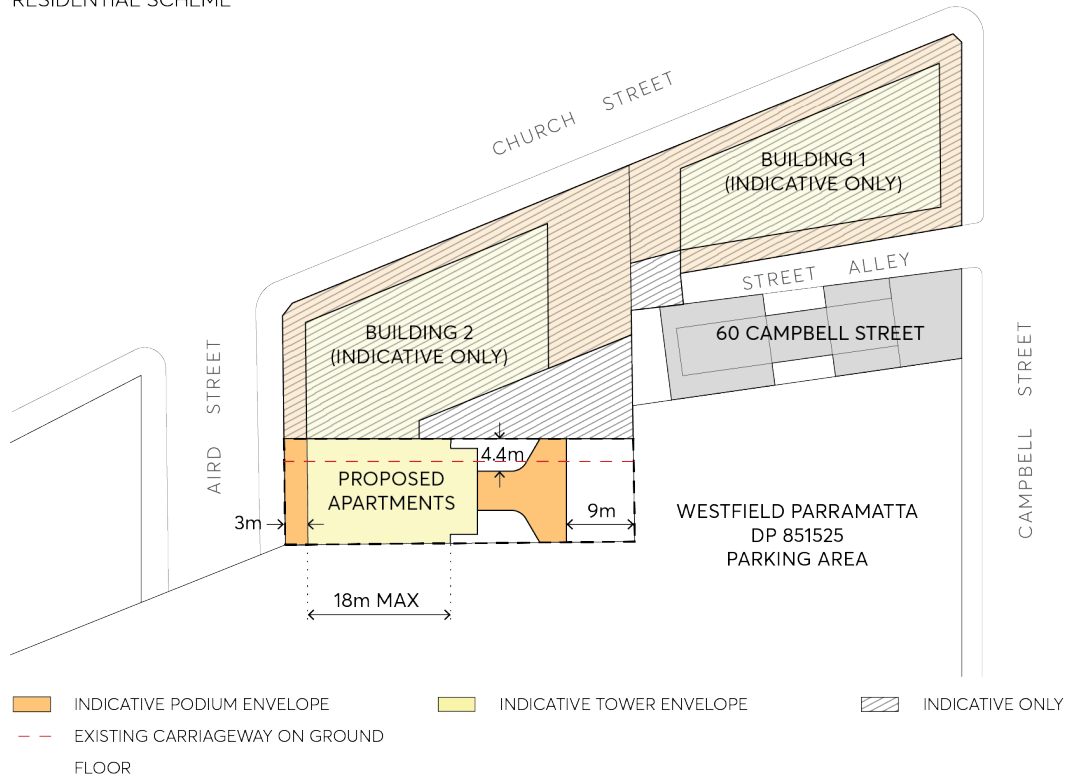

Figure 9.10.9.2 – Residential Scheme Building Envelope

NON-RESIDENTIAL SCHEME

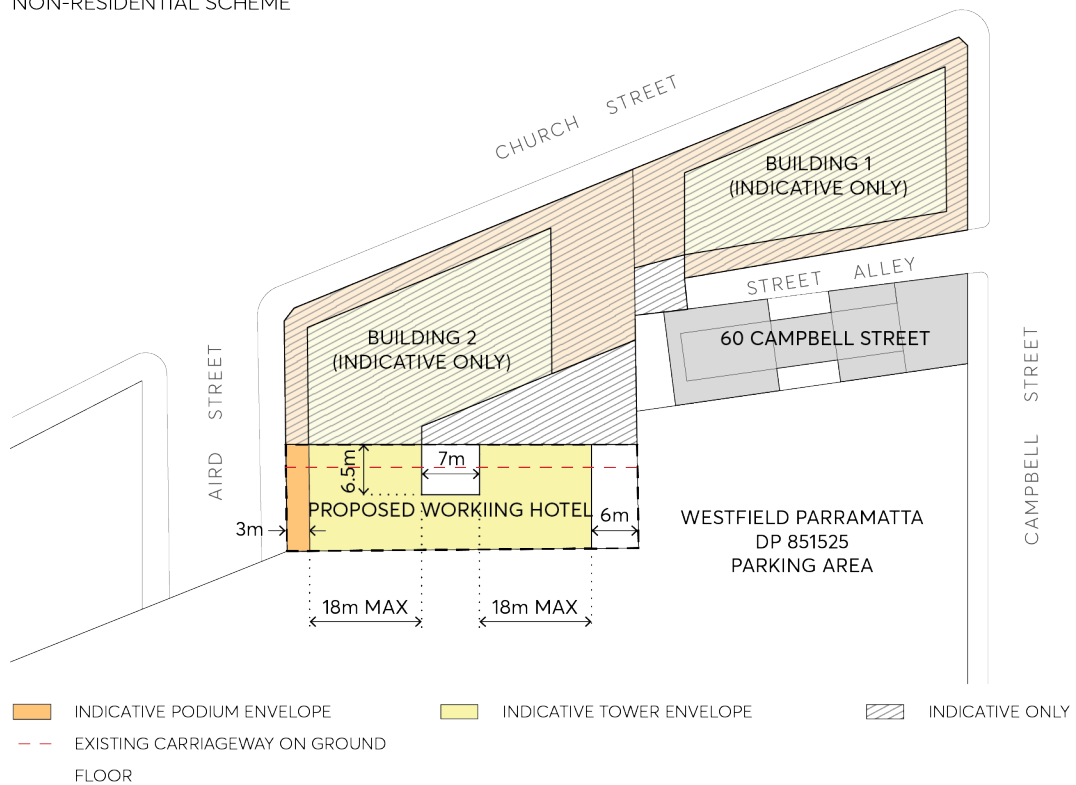

Figure 9.10.9.3 – Non-Residential Scheme Building Envelope

Note – The site is burdened with a Right of Way along its eastern boundary which benefits sites at 129, 131, 135, 137 and 141 Church Street, Parramatta. Nothing within this Section seeks to amend the legal responsibilities of this easement.

9.10.9.2 STREET WALL DESIGN

Objectives

- O.01 Define the space of the streets and articulate their edges.
- O.02 Design the street walls to provide appropriate scale and detail.
- O.03 Design the street walls to achieve fine grain modulation in the street.
- O.04 Provide comfort and shelter for pedestrians.
- O.05 Minimise large expanses of inactive frontage.

Controls

- C.01 The podium street wall must:
 - a) Be modulated in vertical increments that relate to a fine grain subdivision pattern.
 - b) Be of masonry character with no lightweight panel construction.
 - c) Be articulated with depth, relief and shadow on the street façade. A minimum relief of 150mm between the masonry finish and glazing face must be achieved.
 - d) Utilise legible architectural elements and types - doors, windows, loggias, reveals, pilasters, sills, plinths, frame and infill, etc. - not necessarily expressed in a literal traditional manner.
 - e) Include semi-recessed awnings for pedestrian shelter.
 - f) Include a ground floor façade design which intensifies the walking experience with particular richness in detail.
- C.02 Under crofts or disruptions of the street wall which expose the underside of the tower and amplify its presence on the street are not permitted.

9.10.9.3 THE GROUND FLOOR

Objectives

- O.01 Provide for the amenity, interest, and liveliness of the pedestrian street environment.
- O.02 Ensure a positive experience for pedestrians with the necessary fine grain environment of the street.
- O.03 Integrate an engaging street interface with the design of the public domain, taking account of the topography of the site.

- O.04 Optimise the extent of active frontages in the public domain.
- O.05 Ensure appropriate scale and proportion of foyers and lobbies in relation to site frontage.
- O.06 Promote activity, connectivity, and variety in the public domain.
- O.07 Contribute to the economic vitality of the City.
- O.08 Ensure security measures do not inhibit passive surveillance on the street.

Controls

- C.01 The ground floor frontage should have active uses.
- C.02 Semi-recessed awnings must be provided.
- C.03 Columns should not be located within the awning zone outside of the glazed frontage.
- C.04 Glass awnings are not permitted.
- C.05 The ground floor frontage must be designed in detail and the following must be incorporated in its design:
 - a) The ground floor levels and façade structure and rhythm must be designed to present a fine grain street frontage.
 - b) A nominal 500mm interface zone at the frontage should be set aside to create interest and variety in the streetscape, to be used for setbacks for entries, opening of windows, seating ledges, benches, and general articulation.
 - c) The frontage must have a high level of expressed detail and tactile material quality.
 - d) Façades must be vertically articulated.
 - e) The modulation and articulation of the facade should include a well resolved meeting with the ground plane that also takes account of the slope. A horizontal plinth, integrated in the design, must be incorporated at the base of glazing to the footpath.
 - f) The frontage must take account of the need to provide a clear path of travel for disabled access.
 - g) Legible entrances must be formed in the frontage.
 - h) Fire escapes and services must be seamlessly incorporated into the frontage with quality materials.
- C.06 Security doors or grilles must be designed to be:
 - a) fitted internally behind a shopfront;
 - b) fully retractable; and
 - c) a minimum 50% transparent when closed.
- C.07 The frontage must provide for safety of the public and building occupants and not comprise of any unsafe deep recesses, such as entry lobbies.

9.10.10 142-154 MACQUARIE STREET, 118 HARRIS STREET AND 135 GEORGE STREET

This Section of the DCP applies to the street block bound by George Street, Harris Street, Macquarie Street and Argus Lane, the subject site, as shown in Figure 9.10.10.

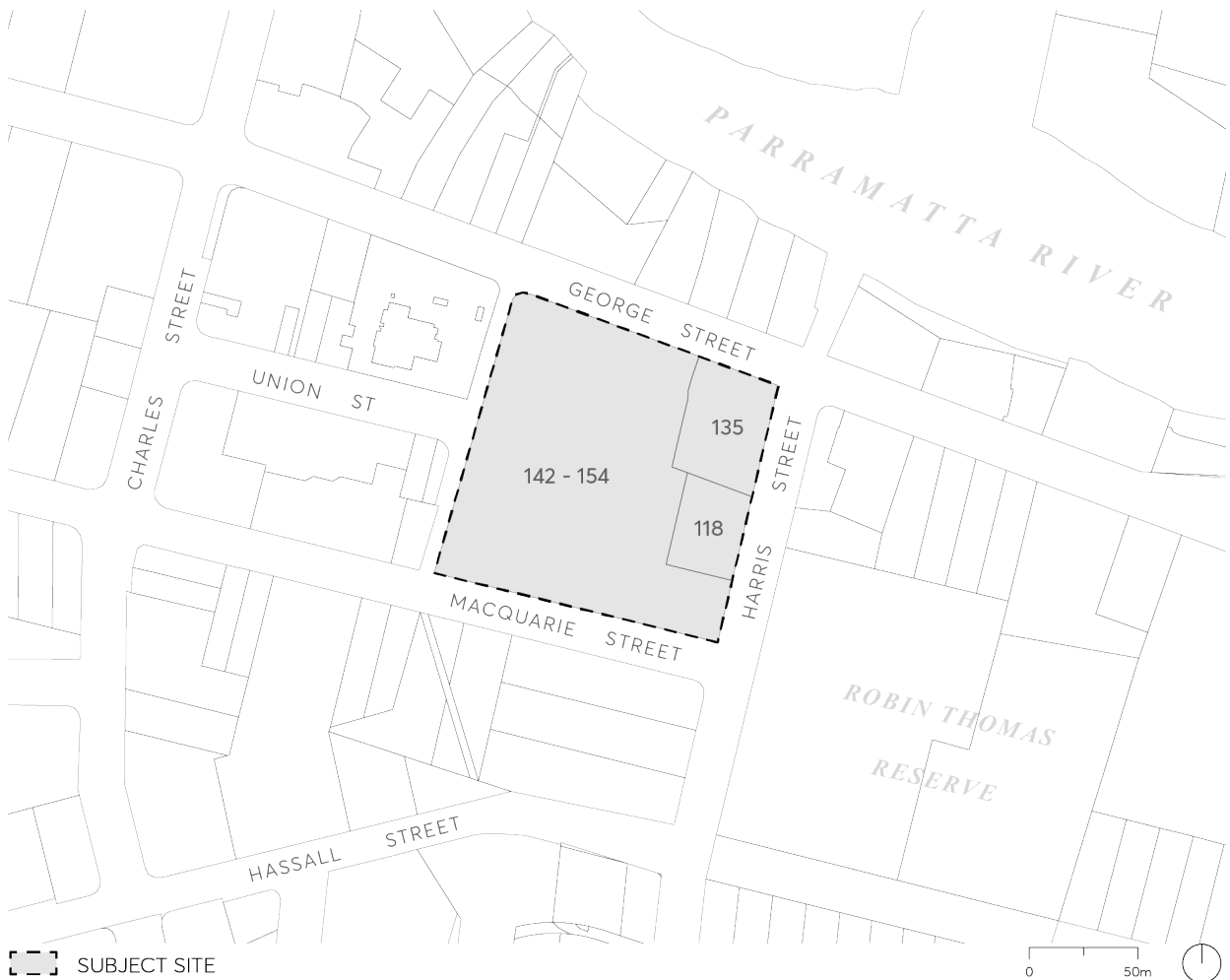

Figure 9.10.10 – Land application map

This Section must be read in conjunction with other Sections of this DCP and the *Parramatta LEP 2023*. The aspects of this Section that relate to the former Cumberland Media site have been prepared in accordance with the winning design from Council's Design Excellence process (LA/353/2015), as per Division 3 Design excellence of *Parramatta LEP 2023*.

This Section of the DCP provides principles, objectives and controls relating to: public domain; building form; access, parking and servicing; and sustainability, microclimate and water.

Where there is any inconsistency between this section and other Sections of PDCP 2023, this Section prevails.

Design Principles

The following design principles support the objectives and development controls for the site.

Relationship to Parramatta City Centre:

- P.01 To revitalise the eastern edge of the Parramatta City Centre and create a new destination for the City.

Architectural Design:

- P.02 To create a high quality, high-density mixed-use development in Parramatta City Centre.
- P.03 To respond to the existing streetscape pattern and scale.
- P.04 To mitigate wind impacts through design of towers and podiums.
- P.05 To provide an accessible open space with separate plaza spaces activated by a variety of retail, cultural, community, entertainment, and commercial uses.

Landscape and Public Domain:

- P.06 To support the amenity of the adjacent parklands and open space.
- P.07 To improve the landscape character and quality of the public domain which adjoins the site.
- P.08 To provide a high quality communal open space.
- P.09 To minimise overshadowing impacts on the open space and heritage items.

Pedestrian Connectivity:

- P.10 To improve connectivity in a north-south and east-west direction across the site and link a series of smaller public open spaces of different shapes and character.
- P.11 To provide active street frontages to George Street and Macquarie Street.
- P.12 To minimise traffic conflicts between pedestrians and vehicles on the site.
- P.13 To integrate pedestrian linkages with the future Light Rail station.

History and Culture:

- P.14 To respond to the history, heritage and archaeological values of the area and incorporate Aboriginal and environmental heritage into the future development through the built elements, streetscape, landscape design and interpretation on the site. The proposed master plan concept for the site is shown on Figures 9.10.10.1 and 9.10.10.2.



Figure 9.10.10.1 – Master plan diagram 1

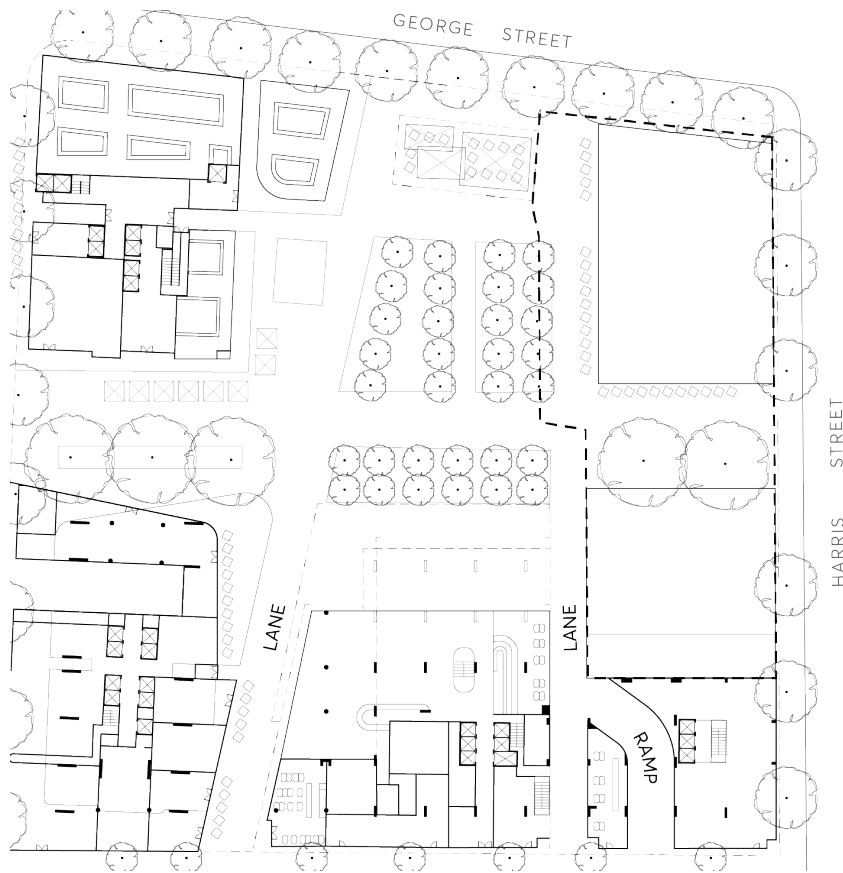

Figure 9.10.10.2 – Master plan diagram 2

Plazas and Walkways

- P.15 The publicly accessible plaza includes publicly accessible walkways and shared spaces within and around the site including streets, lanes and plazas which provide 24/7 access (to be delivered by a planning agreement).

Objectives

- O.01 Enhance the public domain through improvements to the streets and lanes within and adjoining the site and the creation of publicly accessible plazas.
- O.02 Respond to the existing and planned streetscape pattern and scale.
- O.03 Provide active street frontages to George Street and Macquarie Street.
- O.04 Provide a new publicly accessible open space which is activated by a variety of retail, cultural, community, entertainment, and commercial uses.
- O.05 Provide heritage interpretation within the publicly accessible open space.
- O.06 Improve connectivity in a north-south and east-west direction across the site and link a series of smaller public open spaces of different shapes and character.
- O.07 Ensure a high level of pedestrian amenity, safety, and security through the inclusion of weather protection and lighting.
- O.08 Address the new public place to the riverfront.
- O.09 Ensure the Heritage Cottage Pavilion is activated.
- O.10 Ensure that the plazas and walkways respond to the history, heritage, and archaeological values of the area.

Controls

- C.01 New pedestrian walkways and plazas shall be provided in accordance with Figure 9.10.10.3.

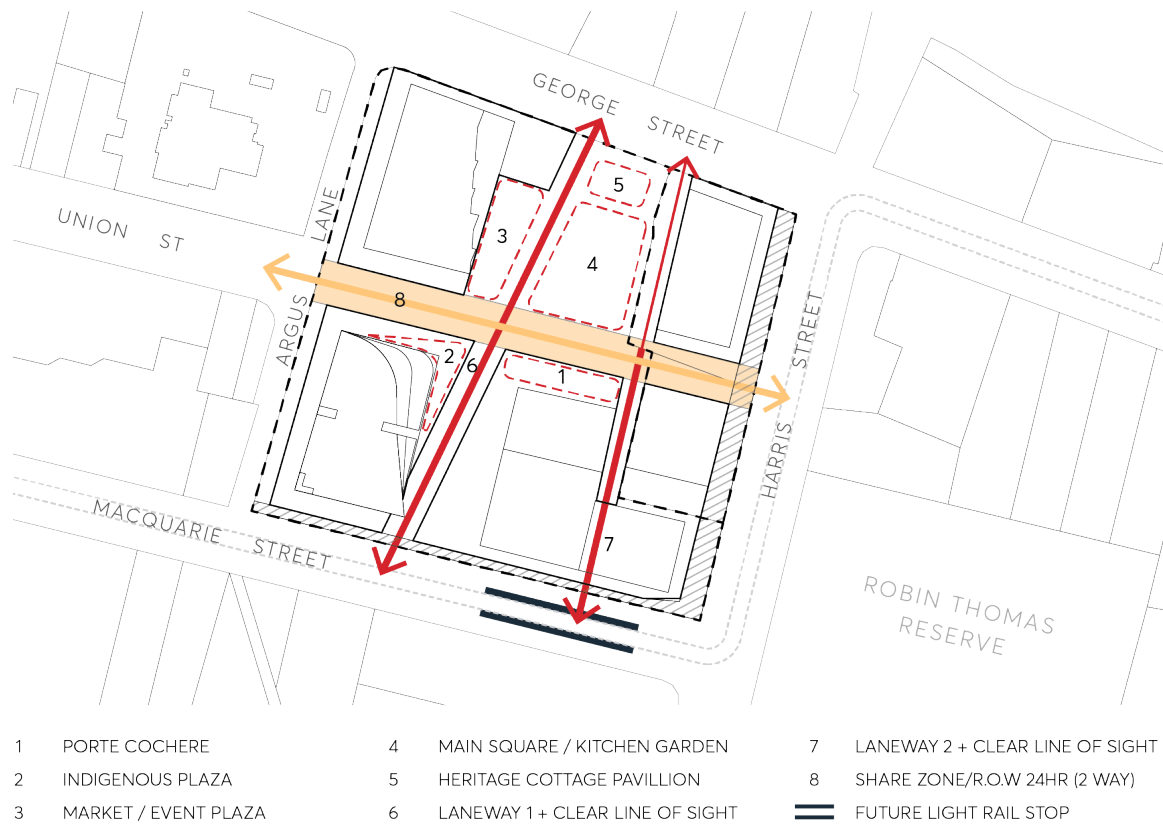

Figure 9.10.10.3 – Open Space – Plazas, walkways and shareways

C.02 New pedestrian walkways, plazas and shareway are composed of the following areas:

- a) Plaza area – minimum 2,500sqm (comprising Plazas 1 to 4)
- b) Shareway – minimum 1,000sqm
- c) Laneways – minimum 850sqm

The total area of the entire public open space to be provided is 4,400m².

C.03 Plaza 3 (Market/Events), 4 (Main Square/Kitchen Garden), 5 (Heritage Cottages Pavilion) are to receive a minimum of 2 hours of solar access between the hours of 10am and 3pm on June 21st to a minimum of 50% of the area.

C.04 The plazas and laneways are designed to celebrate the heritage and archaeological values of the site’s history and location through high-quality public domain design and on-site interpretation, with consideration given to the themes in Figure 6.10.10.3 (above) as well as the descriptions provided in the control table below. Alternate themes that link to the history and values of the site may also be considered (subject to Council’s approval).

Public Domain Plaza	Use / Description
Plaza 3 – Market / Events	<ul style="list-style-type: none"> • Flexible event space in the plaza space adjoining the markets • Market Stalls and seating – grand market containing an eatery within the ground floor of Building 25 (B25). Flexible stalls and seats spill out into the open space and towards the Laneway 1.

Public Domain Plaza	Use / Description
Plaza 4 – Main Square / Kitchen Garden	<ul style="list-style-type: none"> Kitchen Garden - Contained within Heritage Lots 49 & 50. To provide edible gardens containing passive recreation space and supplies of produce to the kitchen garden restaurant (restaurant contained within B25 and serving the Convict Cottages).
Plaza 5 – Heritage Cottages Pavilion	<ul style="list-style-type: none"> An open pavilion structure interpreting the convict cottages on Lots 48 & 49; acting as an educational tool. It also provides sheltered seating for the customers of the Kitchen Garden Restaurant.

- C.05 A two storey under-croft is to be provided along Laneway 2 in the south east building to allow for a clean line of site as indicated in Figure 9.10.10.3.
- C.06 A shareway as indicated in Figures 9.10.10.3 and 9.10.10.10 is to be provided, forming an active spine across the site. The minimum width of the shareway is 12 metres.
- C.07 Continuous street frontage awnings are to be provided along building frontages and along active frontages to provide shade and shelter in accordance with Figure 9.10.10.5.



Figure 9.10.10.4 – Awning location for former Cumberland Media and Albion Hotel sites



Figure 9.10.10.5 – Control diagram: Location of active edges and/or pedestrian entries for former Cumberland Media and Albion Hotel sites

C.08 Frontage, activation and entries:

- a) The site is to provide active frontages on ground level along the public spaces as per Figure 9.10.10.5.
- b) Access to residential and commercial uses above ground level is to be provided directly from plaza or ground level pedestrian walkway.

9.10.10.1 PRIVATE DOMAIN

The private domain comprises a series of spaces within the residential component of the development that are enjoyed by the development's future residents.

Objectives

- O.01 To provide high-quality private open space and recreational facilities within the development, to meet the needs of future residents.
- O.02 Accessible terraces are to provide opportunities to enhance its amenity for residents.

Controls

- C.01 The development is to provide private recreational facilities (a communal gymnasium and pool facility) to complement Robin Thomas Reserve and other local recreation facilities.

- C.02 Each tower within the development must provide high quality communal open space. This is to be in the form of communal gardens or other alternate communal opens space facilities or by way of accessible roof terraces containing landscaped rooftop gardens and activity spaces/uses.
- C.03 Activity spaces/uses are required to suit the orientation, height, proximity, and privacy of the differing levels. Rooftop gardens are to use locally native species.

9.10.10.2 BUILDING FORM

Objectives

- O.01 Establish high quality architectural and urban design of the site.
- O.02 Create three distinct built forms (towers) with heights varying from 25 storeys to 35 storeys to 60 storeys which transition within the site towards the park and the river.
- O.03 Protect the amenity of adjacent parklands and open space, including existing trees in these areas, nearby schools, heritage items and surrounding urban areas by minimising overshadowing impacts.
- O.04 Mitigate wind impacts through design of towers and podiums.

Controls

- C.01 Building envelopes:
 - a) The heights (in storeys) of the podium and tower elements are to be consistent with Figures 9.10.10.6 and 9.10.10.7.



Figure 9.10.10.6 – Height of buildings in storeys



Figure 9.10.10.7 – Section showing double height colonnade and setbacks to tower at the corner of Harris and George Streets

- b) The Heritage Cottages Pavilion is to have no internal and external walls (as it is an open pavilion structure and not part of the GFA of the development).

c) New building forms are to be consistent with dimensions of the street setbacks and above street setbacks as shown in Figures 9.10.10.8, 9.10.10.9 and 9.10.10.10.

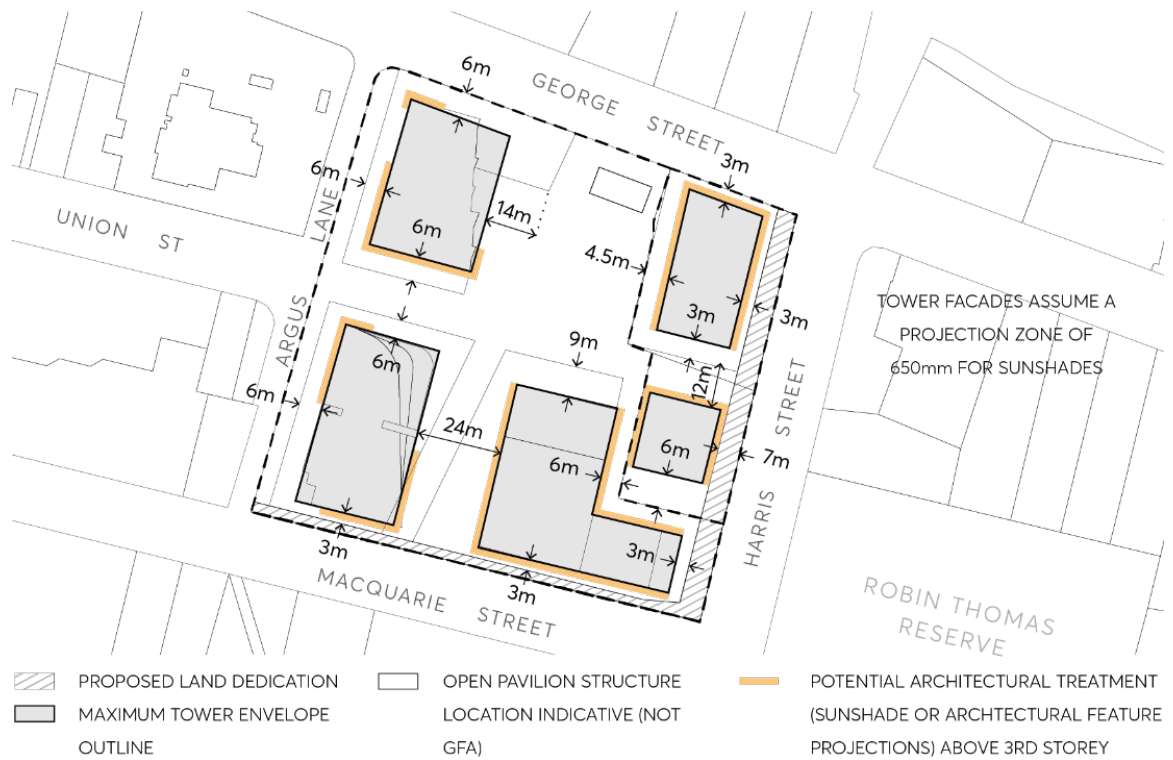

Figure 9.10.10.8 – Control diagram: Setbacks to towers above podium

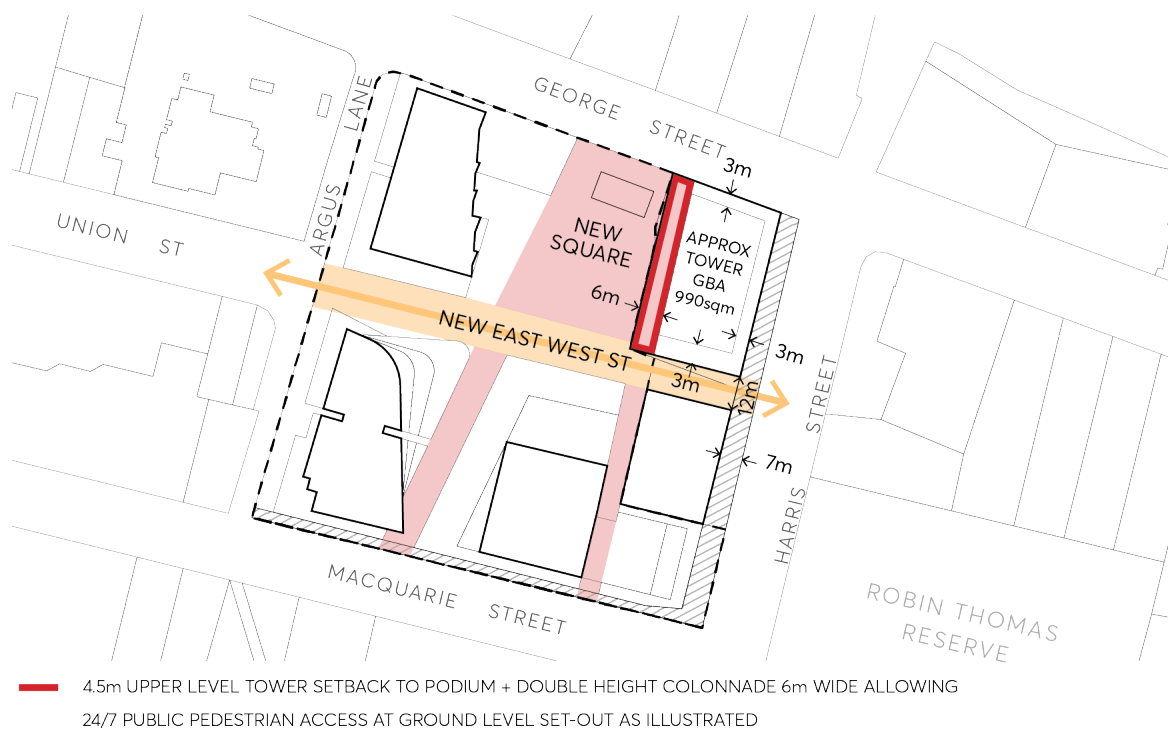

Figure 9.10.10.9 – Height of buildings in storeys and setbacks to towers over podium on former Albion Hotel Site

- d) Residential towers should not exceed the maximum building floor plate of 950m².
- e) The size of a podium floor plate is to be proportional to the height of each tower in order to achieve the effect of a slim tower form. Taller tower forms will require a larger floor plate and lower tower forms will require a smaller floor plate (refer to Figure 9.10.10.8).

C.02 Building podiums are to be consistent with the setbacks shown in Figure 9.10.10.10 and be predominantly non-residential in character.

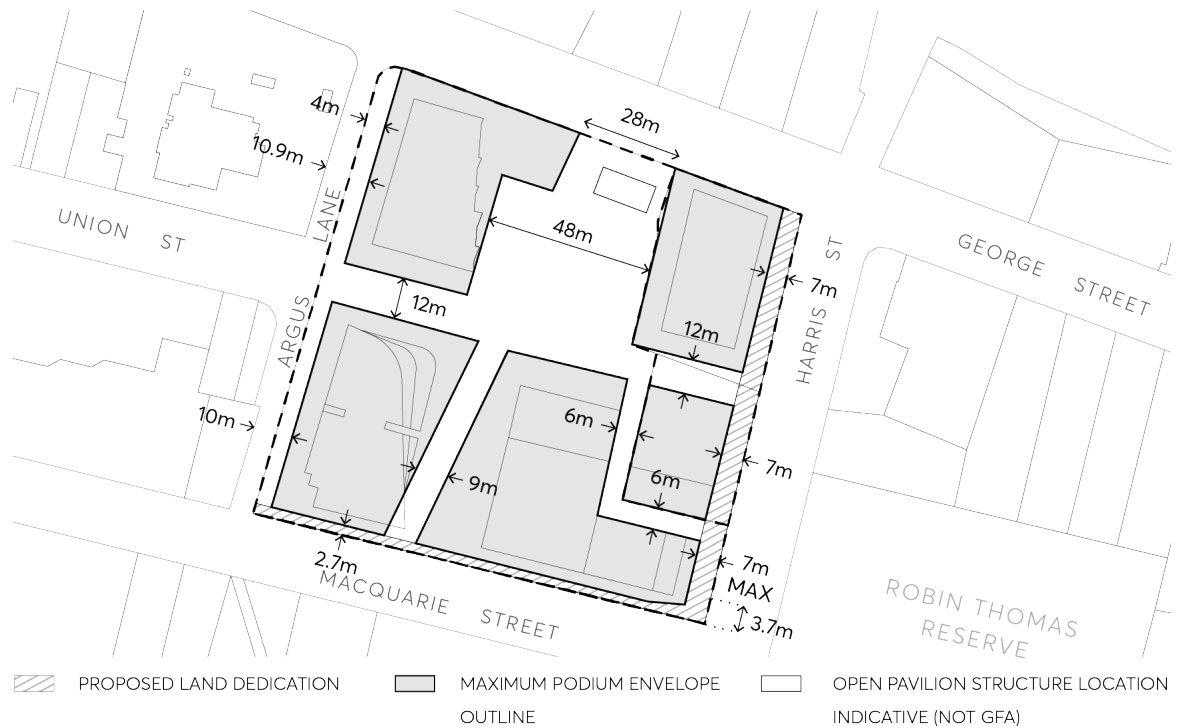

Figure 9.10.10.10 – Setbacks and separations at street level

9.10.10.3 ACCESS, PARKING AND SERVICING

Objectives

- O.01 Connect the new network of spaces to Robin Thomas Reserve.
- O.02 Provide access for vehicles to the site balanced with pedestrian amenity, access, and safety.
- O.03 Improve traffic impacts by widening Argus Lane.
- O.04 Minimise the number of vehicular access and service points along the active frontages in particular along George Street and Macquarie Street.
- O.05 Provide high quality design of the vehicular access areas with high quality materials.
- O.06 Ensure safety by minimising pedestrian and vehicular conflicts through lighting and signage.
- O.07 Reduce the visual impact of above ground car parking.
- O.08 Increase opportunities to use public transport, to cycle or walk to work.

- O.09 Improved pedestrian connectivity through the site to the City Centre.
- O.10 Ensure that the design of the development, below ground structures and basement is sympathetic to the archaeological heritage on the site and provides in situ retention of State Significant Archeology on lot 46, 47, 48 and 49.

Controls

C.01 Vehicular access and servicing:

- a) Vehicular access and egress are to be provided in the locations shown on the Figure 9.10.10.11.

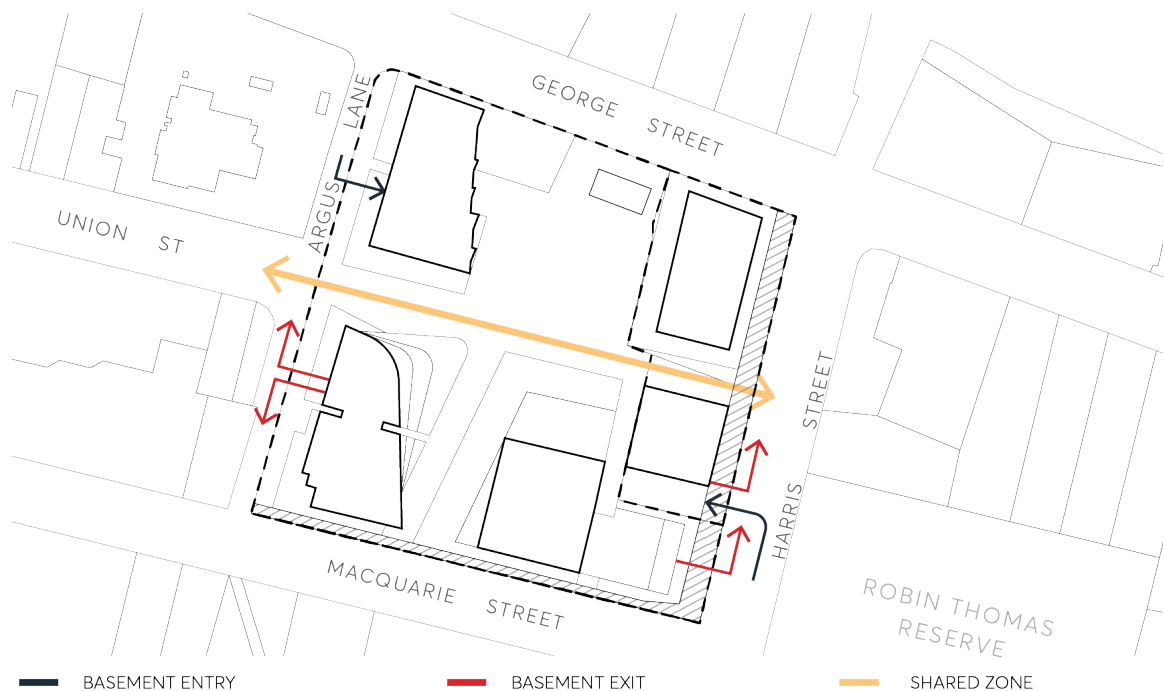

Figure 9.10.10.11 – Vehicular Access and Servicing

- b) Service vehicle access points and utilities are to be minimised along pedestrian routes and adjacent public open space.
- c) A 12 metre wide two-way share way shall connect Argus lane and Harris Street for pedestrian and service vehicle access. The share way shall deny access to private vehicles except for emergency vehicles, vehicles associated with the hotel/serviced apartments (i.e. taxis and hotel deliveries) and loading/unloading during defined loading times. The development application shall address any temporary parking and loading/unloading arrangements to be implemented.
- d) Entry to the share way via Harris Street shall not be permitted. The development application must outline the security measures that will be implemented to control access into the share way such as bollards.
- e) Vehicular and service access widths are to be minimised and incorporated into the building design.

- f) High quality design and materials are to be used for the security shutters into the car park and loading areas. Details of design and materials are to accompany the development application.
 - g) Any on grade or above ground car parking and service areas are to be sleeved with other uses such as commercial and residential and is not to be visible to the public domain.
 - h) Development application plans are to provide evidence of signage and urban design elements that reduce pedestrian and vehicle conflicts over the shared zones illustrated in Figure 9.10.1.10.
 - i) Provide facilities for cyclists such as parking, storage, and end of trip facilities for bicycles in accordance with the relevant sections of this DCP. Additional showers for office buildings and public bicycle racks located within the pedestrian walkways must also be provided to encourage the use of bicycles.
 - j) All loading and servicing provisions are to be made on site. The applicant is to prepare a Freight and Servicing Management Plan (FSMP) and a Loading Dock Management Plan (LDMP) in consultation with Transport for NSW which is to be endorsed by Transport for NSW prior to the issue of any construction certificate.
- C.02 A Travel Plan consistent with Section 6.1.2 – Travel Plans of this DCP must accompany each Development Application stage with the last stage including a comprehensive Travel Plan for the entire development. In addition, the following is also required:
- a) An annual survey to estimate the travel behaviour to and from the site and a review of the measures.
 - b) A copy of the Travel Plan must be available to Council on request.

Travel Plan:

A Travel Plan is a package of measures designed to reduce car trips and encourage the use of sustainable transport. Where a Travel Plan is required as a condition of development, it must be submitted to Council prior to the release of the Occupation Certificate.

If the future occupant(s) are known, then the Travel Plan must be prepared in co-operation with them. The condition of consent remains for the life of the development:

- a) Development that contains 5,000m² of gross floor space or 50 or more employees must prepare a Travel Plan.
- b) Travel Plan must include:
 - Targets: This typically includes the reduction of single occupant car trips to the site for the journey to work and the reduction of business travel particularly single occupant car trips.
 - Travel data: An initial estimate of the number of trips to the site by mode that is required.
 - Measures: a list of specific tools or actions to achieve the target.

- An annual survey to estimate the travel behaviour to and from the site and are view of the measures.
- A copy of the Travel Plan must be available to Council on request.

C.03 A community car share scheme is available for the future residents and is integrated into the development. Development application plans for the basement are to show car share car spaces.

C.04 Pedestrian movement controls:

- a) Provide a series of pedestrian links allowing access from Macquarie Street to the main plaza and George Street and from Argus Lane to the Harris Street as shown on the Figure 9.10.10.12.

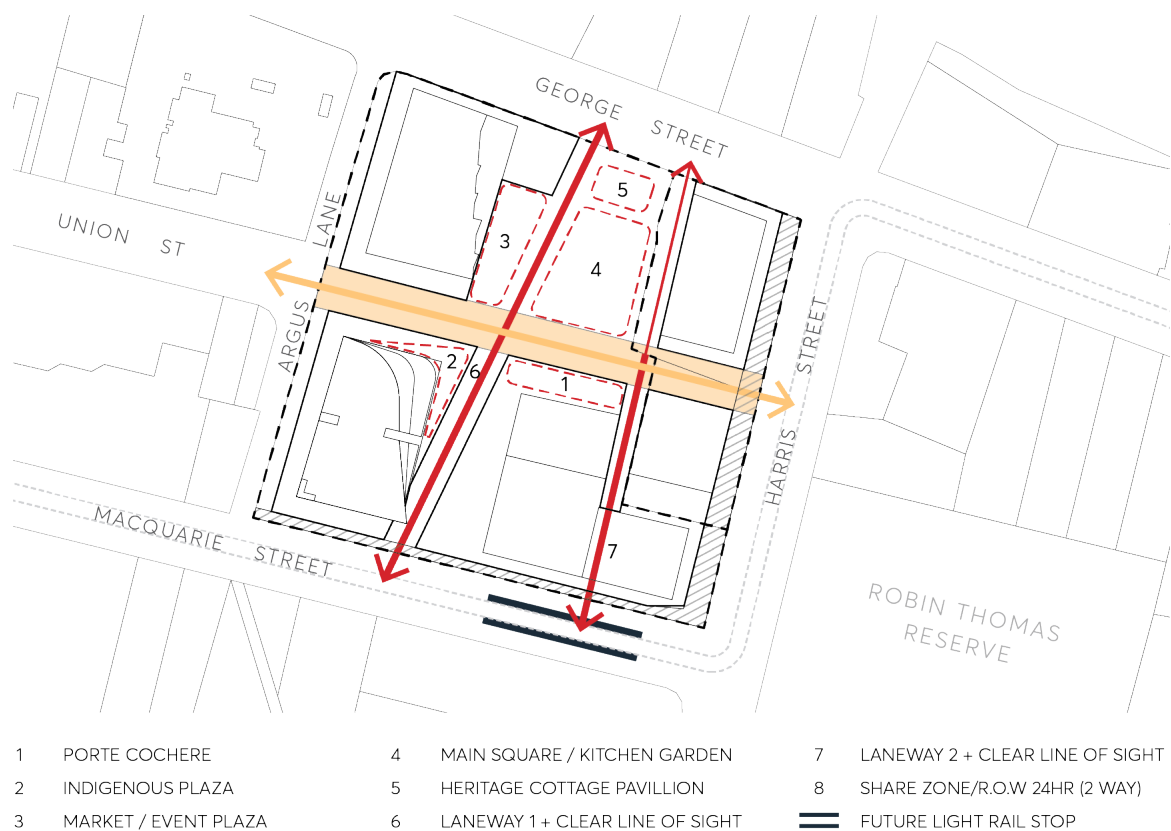

Figure 9.10.10.12 – Pedestrian links and shared zones

- b) The pedestrian links are to be in accordance with the street level setback widths outlined in Figure 9.10.10.12 and the minimum width be no less than 6m.

C.05 Basement and below ground structure controls:

- a) The basement line is not to extend further north (into the protected archaeological zone) than the existing sewer line shown in Figure 9.10.10.14 and shall be designed such that it will not result in adverse heritage impacts on the archaeology in Lots 46, 47, 48 and 49. This is to be demonstrated on the Development Application plans.



Figure 9.10.10.13 – Control diagram: Protected archaeological zone and lots

- b) Ensure that the basement and below ground structures and services allow for the in-situ retention of State Significant Archaeology in lots 46, 47, 48 and 49 in Figure 9.10.10.13. Ramp access and building lift cores are to be located south of the basement line, outside of the protected archaeological zone. This is to be demonstrated on the development application plans.
- c) The design of the piling and foundations for building B25 shall ensure the retention of the archaeology in Lots 46, 47, 48 and 49 in-situ. All piles and structures must fall outside of a one-metre exclusion zone as shown in Figure 9.10.10.14. This is to be demonstrated on the Development Application plans.

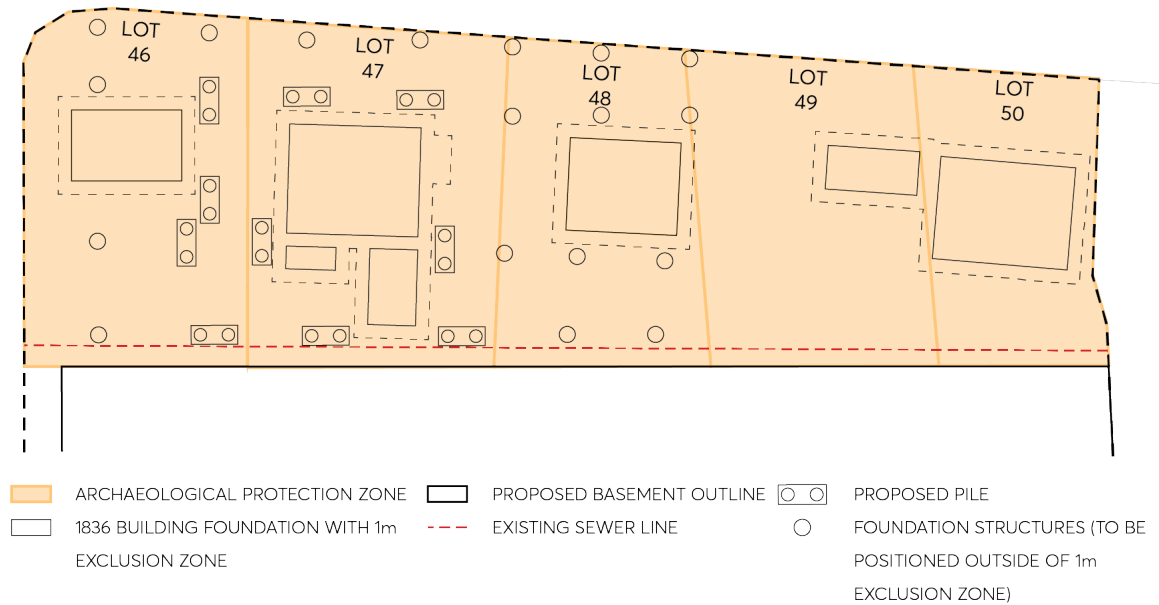

Figure 9.10.10.14 – Control diagram: Piles and structures in relation to archaeological exclusion zone

- d) An application pursuant to Section 140 of the *Heritage Act 1977* is to be submitted with the development application that seeks consent for excavation or below ground works on the site.

9.10.10.4 SUSTAINABILITY, MICROCLIMATE AND WATER

Objectives

- O.01 Use landscape design to respond to summer and winter climatic conditions and improve amenity for people using the open space.
- O.02 Ensure the buildings are designed to minimise detrimental wind generation within public and private open spaces.
- O.03 Implement the principles of water sensitive urban design into the design of the public domain.
- O.04 Minimise reliance on mechanical ventilation through applying good climate design principles to building and public domain design.

Controls

- C.01 Utilise best practice in water sensitive urban design (WSUD) elements for water management infrastructure in the design of the publicly accessible plaza to minimise water use (for e.g. grey water for irrigation and surrounding trees). Details are to be provided with the Development Application.

- C.02 Drought tolerant planting is to be used for landscape planting in the public domain and private communal open spaces.
- C.03 Water features within the plaza space (i.e. the civic reflection pond) shall make use of water harvested from the development.
- C.04 Incorporate appropriate built form structures/shade structures to create appropriate microclimate in public domain areas, to ameliorate the temperature extremes of summer and winter.
- C.05 For optimal internal amenity, the design of dwellings is to maximise sunlight access to private open spaces of the individual units, and communal areas of the building.
- C.06 The design of buildings is to maximise natural/cross ventilation to individual units, corridors, and lobbies (including lift lobbies) within the development in accordance with the ADG.
- C.07 Lobbies (including lift lobbies) and corridors within all towers are to be designed to maximise use of natural light to reduce reliance on artificial lighting in accordance with the ADG.
- C.08 Achieve a 5 Star Green Star Design and As-built rating for any commercial office or commercial hotel components. Evidence is provided by a Design Review certified rating from the Green Building Council of Australia at CC stage for any relevant building portion.
- C.09 Consideration shall be given to the provision of solar hot water and solar photovoltaics within the development. Panels should be located to optimise orientation and efficiency and avoid areas that are overshadowed. If this cannot be achieved, evidence must be provided with the Development Application.
- C.10 The provision of an on-site Central Energy Plant is to be considered in the design of the development. If this cannot be provided, alternative energy efficient mechanical systems must be incorporated into the development such as floor by floor condensers or centralised plant room for air-conditioning. Evidence must be provided with the Development Application.

9.10.10.5 FLOOD RISK MANAGEMENT

Objectives

- O.01 To facilitate redevelopment of the site as a high-quality mixed use development.
- O.02 To ensure the building interfaces positively with the public areas and contributes to an attractive public domain and desirable setting for its intended uses.
- O.03 To ensure the design of the building addresses the local flood conditions and does not impede local overland flow paths.
- O.04 To minimise the risk to life by ensuring appropriate safe areas within the building to shelter during a flood, and safe access from the building during a medical or fire emergency.
- O.05 To allow uses and development on the site that are appropriate to the flood hazard.

Controls

Building Footprint and Uses

- C.01 All structures must have flood compatible building components below the PMF.
- C.02 Residential lobbies must be located above the PMF, where access points to basement levels are provided in the residential lobby level.
- C.03 All habitable rooms/floors must be above the 1% annual exceedance probability (AEP) flood level plus 0.5m freeboard.

Building and Basement Design

- C.04 To minimise the chance of a fire during a flood situation, the building must have a fire management system which meets the Australian Building Code Board (ABCB).
- C.05 External fire doors must be located above the 1% annual exceedance probability (AEP) flood level plus 0.5m freeboard.
- C.06 To prevent flood waters from entering the basement car park, a driveway crest at or above the flood planning level (1% AEP flood level plus 0.5m freeboard) including associated bund walls must be provided. Above this, at or near the crest of the driveway, a passive automatic flood barrier up to the probable maximum flood (PMF) must be installed. Flood doors and other measures must also be provided to ensure flood waters up to the PMF cannot enter the basements.
- C.07 Wherever possible, critical services infrastructure that could be damaged by flooding such as electrical, lift, sewer and water are to be placed above the PMF level, or, where that cannot reasonably be achieved, effectively floodproofed.
- C.08 Development Application submission requirements must:
 - a) demonstrate that the building and basement will be protected from floodwaters up to the PMF; and
 - b) include evidence demonstrating why all or some of the critical infrastructure services cannot be located above the PMF and the floodproofing measures to be taken instead.

Areas of Refuge and Evacuation Routes

- C.09 All building occupants (residents, workers, and visitors) must have access to a safe area of refuge above the PMF where they can remain until the flood event has passed and any subsequent disruption after the flood has been rendered safe and serviceable. A safe area of refuge can be within a resident's own apartment, and or a communal area for workers, residents, and visitors.
- C.10 A communal safe area of refuge must have emergency electricity, clean water, food, ablutions, and medical equipment including a first aid kit.
- C.11 All safe areas of refuge (resident's own apartment or a communal area) must have:
 - a) fail safe access from anywhere in the building (elevator access is not allowed) that is protected from floodwaters up to the PMF by suitable flood doors, flood gates and the like; and

- b) fail safe access to an exit/entry point located above the 1% AEP flood level plus 0.5m freeboard that enables people to exit the building during a fire and/or flood, and allows emergency service personnel to enter a building to attend to a medical emergency.
- C.12 The buildings exit/entry points located above the 1% AEP flood level plus 0.5m freeboard, must enable a safe route above the 1% AEP from the site to a flood free location above the PMF.
- C.13 Development Application submission requirements must include a Flood Emergency Response Plan (FERP) consistent with the FERP for the City Centre. The FERP must outline:
- a) both warning and evacuation measures for occupants in the building including the most appropriate 'safe areas' and 'safe evacuation routes';
 - b) measures to prevent evacuation from the site by private vehicle;
 - c) the most appropriate emergency response for flood and fire events that occur together;
 - d) a building flood emergency response plan, similar to a building fire evacuation drill, and measures to ensure this is tested at least annually; and
 - e) consultation undertaken with relevant state and local agencies in the preparation of the FERP.

Applicable flood levels

- C.14 The Applicant must make a 'Flood Enquiry' to Council to obtain adopted flood levels for the Parramatta River for this site.
- C.15 Council may also require the Applicant to carry out an overland flow flood study of the rainfall catchment that directly affects this site.
- C.16 The applicable 1% AEP flood level and the corresponding flood planning level will be the higher of the river and the overland flow flood levels.
- C.17 The applicable PMF level will be that advised for the Parramatta River flood.

9.10.11 33-34 MARION STREET

This Section applies to land at 33-43 Marion Street, Harris Park, as illustrated in Figure 9.10.11. The subject site comprises seven (7) allotments and totalling 2,367.5m². also shown in Figure 9.10.11.



Figure 9.10.11 – Land application map

This Section must be read in conjunction with other sections of Parramatta DCP 2023 and the relevant provisions within *Parramatta LEP 2023*. If there is any inconsistency between this section and other sections of this DCP, this Section prevails.

This Section establishes relevant development controls for the built form and urban design objectives for subject site including setbacks, pedestrian and heritage interface, vehicular access and movement, and landscaping.

Re-development of this site will be subject to a design excellence competition process under Division 3, Part 7 Design excellence in *Parramatta LEP 2023*. The scope of this brief will be informed by the urban design outcomes and principles identified by this DCP.

9.10.11.1 BUILT FORM OBJECTIVES

The site has two main frontages, with 62 metres to Marion Street and 35 metres to Station Street West. The site has a secondary frontage to the south to Peace Lane of 60 metres, and a 40 metre boundary to a heritage item to the west at 31 Marion Street.

The objectives have been developed to respond to the context of the site, and in doing so maximise the building interface with the two primary frontages, encourage permeability at the ground plane, and to manage the interface between existing and new development.

Objectives

- O.01 To facilitate the provision of a mixed-use development on the site.
- O.02 To provide an improved, pedestrian-friendly environment.
- O.03 Activate ground floor space, particularly along Marion Street.
- O.04 Ensure a suitable interface with adjoining heritage items.
- O.05 Create a permeable ground plane through visual and physical connections and maximise permeability.
- O.06 Ensure through-site links provide a high level of pedestrian amenity, safety, and security.
- O.07 To provide for access and vehicular movements away from the two key active frontages along Marion Street and Station Street West.

Built Form Controls

Alignment

- C.01 The site is to have a variable alignment to Marion St. Buildings located on the eastern portion shall be parallel to Marion Street. Buildings located on the western portion of the site are to be setback and align with the adjoining heritage item and be perpendicular to the subdivision pattern. Refer to Figure 9.0.11.2.

Podium Setbacks

- C.02 Minimum of 3 metres from northern boundary (eastern half of building) and a minimum of 6 metres (western half of building).
- C.03 Minimum 6 metre setback to the east (Station Street West).
- C.04 Minimum 4 metre setback to the south (Peace Lane).
- C.05 Minimum 6 metre setback to the west (31 Marion Street).

Basement Setbacks, Planting and Ingress/Egress

- C.06 Eastern and western setbacks to be deep soil zones – no basement underneath.
- C.07 Vehicle entry to be located on the south of the site via Peace Lane.
- C.08 Ingress and egress points must be contained within the envelope of the building.

Tower Setbacks from Boundary

- C.09 Minimum 9 metres and variable to northern boundary (Marion Street).
- C.10 Minimum 9 metres to the eastern boundary (Station Street West).
- C.11 Minimum 6 metres to southern boundary (Peace Lane).
- C.12 Minimum 12 metres to western boundary (31 Marion Street)

Built Form

- C.13 Maximum tower building length of 45 metres.
- C.14 Maximum tower building depth of 23 metres.
- C.15 Maximum podium footprint of 1,565m².
- C.16 Maximum tower footprint of 955m².

Public Domain

- C.17 Tree planting is to be maximised across the site.
- C.18 If awnings are provided, they are to be consistent with [Parramatta Public Domain Guidelines](#).
- C.19 Publicly accessible through-site link is to be provided along the western setback to 31 Marion Street.
- C.20 The through-site link is to be legible, provide a clear path of travel, open to the sky, and well-lit at night.
- C.21 3 metres of the northern and western setback are to be publicly accessible to allow for footpath widening.
- C.22 Active frontages are to be provided on Marion Street and Station Street West.

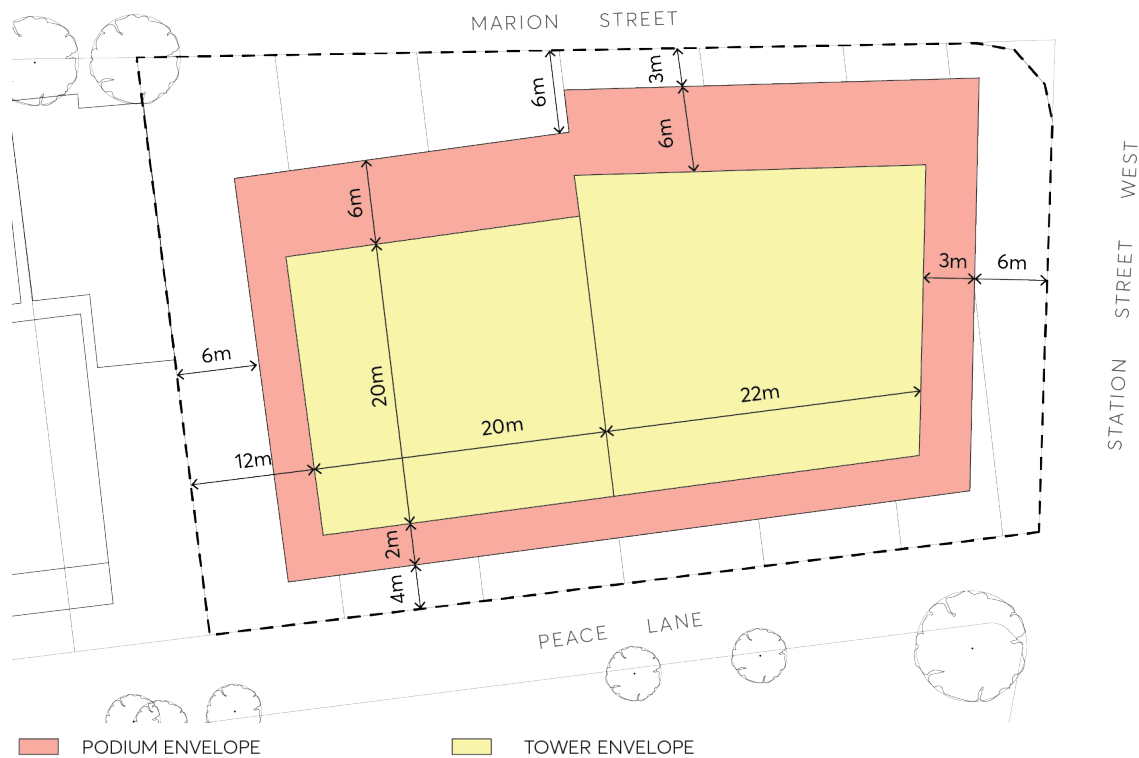

Figure 9.10.11.2 – Building alignment and setbacks

9.10.12 2 O'CONNELL STREET, PARRAMATTA

This Section applies to land at 2 O'Connell Street, Parramatta, also known as 5 Aird Street (formally known as SP20716) as illustrated in Figure 9.10.12.



Figure 9.10.12 – Land application map

This Section is to be read in conjunction with other sections of this DCP and the relevant provisions within *Parramatta LEP 2023*. If there is any inconsistency between this Section and other sections of this DCP, this section prevails.

This Section establishes objectives and controls to be interpreted during preparation and assessment of development applications and supports the objectives of the relevant provisions within *Parramatta LEP 2023*.

Guiding Principles

- P.01 Facilitate redevelopment of the site as a high-quality mixed-use development to support the role of the Parramatta City Centre.
- P.02 Contribute to the public domain at ground level through activated edges to Aird Street, O'Connell Street, and Campbell Street.

- P.03 Design the street walls to create streets that are legible, comfortable, safe, functional, and attractive.
- P.04 Design the street walls to respond to existing built and heritage context.
- P.05 Protect, frame, and enhance the axial view corridor from the entry gate to St John's cemetery along Aird Street.
- P.06 Set back buildings above the street walls and side and rear boundaries to allow daylight penetration, mitigate wind impacts and enable views to the sky in streets and public places.
- P.07 Design the tower to be elegantly proportioned and maximise its slenderness of form.
- P.08 Protect amenity, daylight penetration, views to the sky and privacy between adjoining developments, and minimise the negative impacts of buildings on the amenity of the public domain.
- P.09 Design and select the materials of buildings and the public domain to contribute to a high quality, durable, and sustainable urban environment.
- P.10 Satisfy the standards of SEPP 65 and the Apartment Design Guide (ADG).

9.10.12.1 BUILDING ENVELOPES

Objectives

- O.01 Reinforce the spatial definition of the streets.
- O.02 Design the street walls with an appropriate human scale and sense of enclosure for the streets.
- O.03 Ensure that the axial view corridors from the entry to St John's cemetery and along Aird Street are respected through the podium and recessed tower built form.
- O.04 Protect daylight access at street level and permit views of sky from the streets by providing setbacks above street frontage height that promote separation between buildings.
- O.05 Ensure that building form achieves comfortable public domain conditions for pedestrians, with adequate daylight, appropriate scale, and mitigation of wind effects of the tower building.
- O.06 Ensure that the ground level interface provides shelter for pedestrians in the form of an awning as well as adequate space for street trees.
- O.07 Ensure that built form achieves contextual fit with adjacent buildings on Aird and Campbell St.
- O.08 Ensure that built form enables a healthy environment for street trees.

Controls

- C.01 Building envelopes must be consistent with Figure 9.10.12.1.

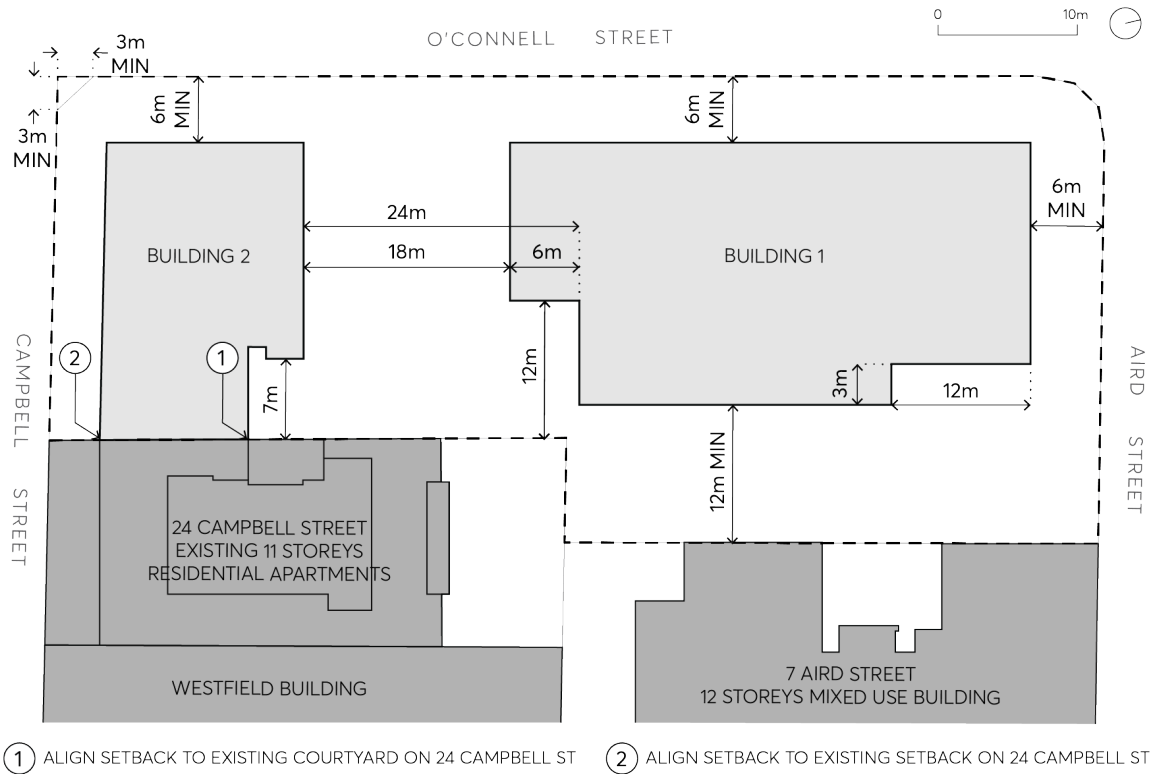

Figure 9.10.12.1 – Building Envelopes

C.02 The street wall must be built to the street boundary along its full frontage on Aird, O'Connell and Campbell Streets, except at Ground Level which must be set back 1.2m from the boundary, refer to Figure 9.10.12.2.

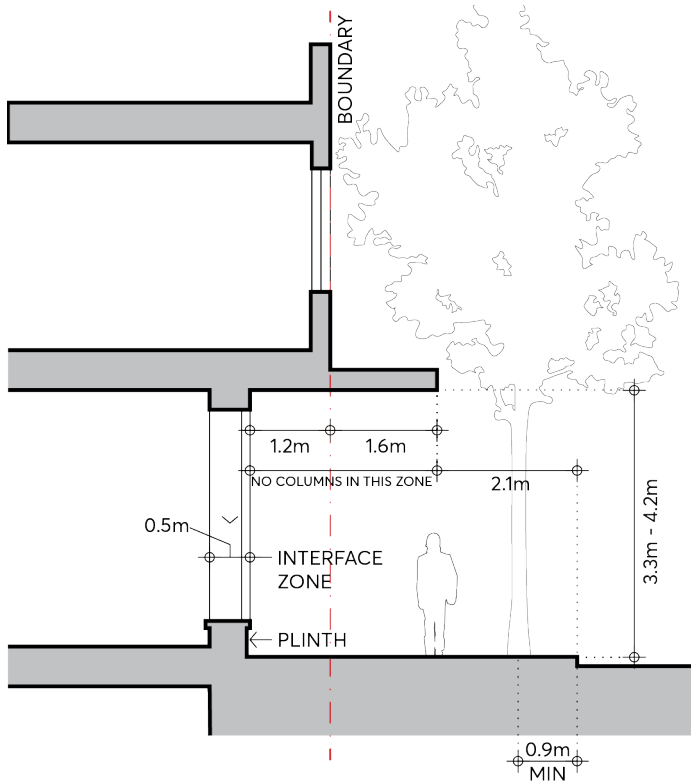

Figure 9.10.12.2 – Street Section Aird St, O'Connell St and Campbell St

- C.03 The street wall must incorporate a minimum splayed setback of 3 metres from the corner intersections for its full height.
- C.04 Minor recesses in the street wall profile for modulation and articulation are permissible.
- C.05 Above the street wall:
 - a) Building 1 must be set back a minimum of 6 metres on O'Connell St and Aird St.
 - b) Building 2 must be set back a minimum of 6 metres on O'Connell St and line up with the existing adjacent building to the east on 24 Campbell St.
- C.06 Setbacks must be measured perpendicular to the boundary to the outer faces of the buildings.
- C.07 The height of the street wall must be a minimum of 12.5 metres and a maximum of 21 metres from natural ground at footpath level. The height of the street wall at Aird and Campbell Streets must relate to the existing adjacent buildings.
- C.08 Building 2 must be limited in height to 39 metres.

9.10.12.2 STREET WALL DESIGN

Objectives

- O.01 Define the space of the streets and articulate their edges.
- O.02 Design the street walls to provide appropriate scale and detail.
- O.03 Design the street walls to achieve fine grain modulation in the street.
- O.04 Provide comfort and shelter for pedestrians.
- O.05 Minimise large expanses of inactive frontage.

Controls

- C.01 The street walls must:
 - a) Be modulated in vertical increments that relate to a fine grain subdivision pattern.
 - b) Be of predominantly masonry character with limited amounts of glass and no lightweight panel construction.
 - c) Be articulated with depth, relief and shadow on the street façade. A minimum relief of 150mm between the masonry finish and glazing face must be achieved.
 - d) Utilise legible architectural elements and types - doors, windows, loggias, reveals, pilasters, sills, plinths, frame and infill, etc. - not necessarily expressed in a literal traditional manner.
 - e) Include semi-recessed awnings for pedestrian shelter, refer to Figure 9.10.12.2.

- f) Include a ground floor façade design which intensifies the walking experience with particular richness in detail, refer to The Ground Floor below.
- C.02 Under crofts or disruptions of the street wall which expose the underside of the tower and amplify its presence on the street are not permitted.

9.10.12.3 THE GROUND FLOOR

Objectives

- O.01 Provide for the amenity, interest, and liveliness of the pedestrian street environment.
- O.02 Ensure a positive experience for pedestrians with the necessary fine grain environment of the street.
- O.03 Integrate an engaging street interface with the design of the public domain, taking account of the topography of the site.
- O.04 Optimise the extent of active frontages in the public domain.
- O.05 Ensure appropriate scale and proportion of foyers and lobbies in relation to site frontage.
- O.06 Promote activity, connectivity, and variety in the public domain.
- O.07 Contribute to the economic vitality of the City.
- O.08 Ensure security measures do not inhibit passive surveillance on the street.

Controls

- C.01 Active uses must fully occupy the ground floor frontage not taken up by services which should be minimised.
- C.02 Any carparking or related functions on the ground floor frontage are not permitted.
- C.03 The minimum depth of tenancy must be 4 metres, with an unobstructed view to a depth of 4 metres.
- C.04 Foyers and lobbies must be a minimum of 3 metres and a maximum of 5 metres of the frontage width.
- C.05 Semi-recessed awnings as well as street trees must be provided, refer to Figure 9.10.12.2.
- C.06 The existing street trees adjoining the O'Connell Street frontage of the site are to be replaced with species identified within the [Parramatta Public Domain Guidelines](#) as part of an enhanced public domain adjoining this part of the site using Council's standard street tree pit details, available on request. Enhancement of the public domain also includes the upgrading of the footpath pavement identified within the [Parramatta Public Domain Guidelines](#) adjoining this part of the site.
- C.07 The design of the Campbell St public domain and frontage must remove the existing split level footpath.
- C.08 Columns must not be located within the awning zone outside of the glazed frontage.

- C.09 Double height awnings are not permitted.
- C.10 Glass awnings are not permitted.
- C.11 The ground floor frontage must be designed in detail and the following must be incorporated in its design:
- a) The ground floor levels and façade structure and rhythm must be designed to present a fine grain street frontage.
 - b) A nominal 500mm interface zone at the frontage must be set aside to create interest and variety in the streetscape, to be used for setbacks for entries, opening of windows, seating ledges, benches, and general articulation, refer Figure 9.10.12.2.
 - c) The frontage must have a high level of expressed detail and tactile material quality.
 - d) Façades must be vertically articulated.
 - e) The modulation and articulation of the facade should include a well resolved meeting with the ground plane that also takes account of the slope. A horizontal plinth, integrated in the design, must be incorporated at the base of glazing to the footpath.
 - f) The frontage must take account of the need to provide a clear path of travel for disabled access.
 - g) Legible entrances must be formed in the frontage.
 - h) Fire escapes and services must be seamlessly incorporated into the frontage with quality materials.
- C.12 Security doors or grilles must be designed to be:
- a) fitted internally behind a shopfront;
 - b) fully retractable; and
 - c) a minimum 50% transparent when closed.
- C.13 Parking security grilles or doors must be aligned to the building edge.
- C.14 The frontage must not have deep recesses for entry lobbies that compromise safety.

9.10.12.4 HERITAGE

Objectives

- O.01 Ensure development demonstrates an appropriate transition to any heritage items or heritage conservation areas.

Controls

- C.01 Development is to provide a transition in building height from the St Johns Anglican Cemetery to the tower structure through the use of podiums, awnings and other design features. A podium and awning that complies with control C0.7 under the heading "Building Envelopes" is considered to provide an appropriate transition for the purpose of this control.

9.10.12.5 MATERIALS**Objectives**

- O.01 Ensure the development does not compromise the amenity or safety of the public domain and surrounding building occupants.

Controls

- C.01 Development is to comply with the controls relating to Building Exteriors and Section 9.8 – Environmental Sustainability. In particular, materials selection is to minimise reflectivity and glare impacts.

9.10.13 12 HASSALL STREET

This Section applies to land at 12 Hassall Street, Parramatta (formally described as Lot 156 DP1240854) as shown in Figure 9.10.15.



Figure 9.10.13 – Land application map

This Section is to be read in conjunction with other sections of this DCP and the relevant provisions within *Parramatta LEP 2023*. If there is any inconsistency between this Section and other Sections of this DCP, this Section prevails.

This Section provides site-specific objectives and design controls to achieve development that is consistent with the desired future character.

9.10.13.1 DESIRED FUTURE CHARACTER

The location of the site is within a street that is undergoing transition to higher density development. The site is adjacent to the Police Headquarters building which includes a large void of the car parking ramps directly to the west and substantial building behind.

Future uses on this site have regard to the proximity and scale of the Police Headquarters building. The site is located within close proximity to Parramatta Railway Station and the Parramatta bus interchange and therefore supports the increased intensity of uses and encourages public transport usage to minimise private car dependency.

The mixed use character complements the transitioning nature of the south-western area, within the Parramatta City Centre. The development of this site provides a mix of uses including retail, commercial and the opportunity for community facilities and residential.

The building form provides a 4 storey podium with a recessed tower above to reduce bulk and scale, provide articulation and concentrate building form to the west to maintain and enhance daylight to the future mixed use building and adjoining sites.

The building form provides an active street front along Hassall Street integrates with adjoining development.

Development complies with the objectives and controls set out below and any other relevant objectives and controls of this Section.

Objectives

Site Objectives

All development is to be consistent with the following site objectives:

- O.01 To respond to the role of Parramatta as Metropolitan Centre for the Central City District under the [Central City District Plan](#).
- O.02 To provide a mix of uses that support the role of the Parramatta City Centre reinforcing and complimenting the centre's core employment role.
- O.03 To strengthen the built form relationship and provide appropriate development along the transitioning south-western edge of the Parramatta City Centre.
- O.04 To contribute to the revitalisation of the Parramatta City Centre and to support activation of the public domain.
- O.05 To encourage design excellence and high-quality built form.
- O.06 To provide a safe, active, and landscaped public domain.

9.10.13.2 BUILDING FORM

The provisions in this Section are intended to encourage a high-quality mixed use building form that will complement the City Centre and support the centre's core employment role. A new building form should contribute to an active and improved public domain that will create a positive transition with existing development along the south-eastern edge of the Parramatta City Centre.

The building form is required to have a four storey podium at street level to define the street edge and narrow to a tower form above to maximise daylight and ensure the development and adjoining properties receive a high level of solar access.

Objectives

- O.01 To provide an appropriate building scale that will provide appropriate setbacks to ensure a high level of amenity for future residents and adjoining sites.

- O.02 Create a street edge consistent with surrounding development and provide street definition.
- O.03 Ensure the building allows for appropriate setbacks to maintain high levels of solar access, maintain privacy and allow for view sharing.
- O.04 Ensure that building form is appropriately articulated and modulated to minimise building bulk and scale.

Controls

Refer to Figures 9.10.13.2 to 9.10.13.4 which illustrate built form diagrams to support the setbacks outlined below.

Maximum Street Frontage Height

- C.01 Maximum podium height of 4 storeys (15 metres), to match adjoining podium at 14 Hassall Street.

Maximum Tower Height

- C.02 Maximum tower height of 61 storeys (192 metres).

Street Frontage Setbacks

- C.03 The podium shall have a nil setback from Hassall Street.

Basement Setback

- C.04 The basement carpark shall be setback from the northern boundary to provide opportunity for deep soil landscaping along the boundary.

Building Setbacks above Maximum Street Frontage Height

- C.05 The tower shall have a minimum setback of 6 metres from Hassall Street.
- C.06 Balconies are generally to be located within the building envelope, however may extend beyond the envelope to provide articulation to the building form.
- C.07 Minor projections into the front building line setback for sun shading devices, entry awnings and building elements are permissible, but shall not extend further than 450mm.

Podium Side and Rear Setbacks

- C.08 The podium shall have a flexible setback of between nil to 6 metres from the western boundary.
- C.09 The podium shall have a minimum rear setback of 12 metres, variation to the rear setback to achieve a better urban design outcome may be considered.
- C.10 The podium shall have no setback from the eastern boundary.

Tower Side and Rear Setbacks

- C.11 The tower shall have a minimum setback for 6 metres from the western boundary.
- C.12 The tower shall be setback in accordance with the separation distance requirements of the Apartment Design Guide. The setbacks of the tower should ensure compliant solar access to the proposed units.

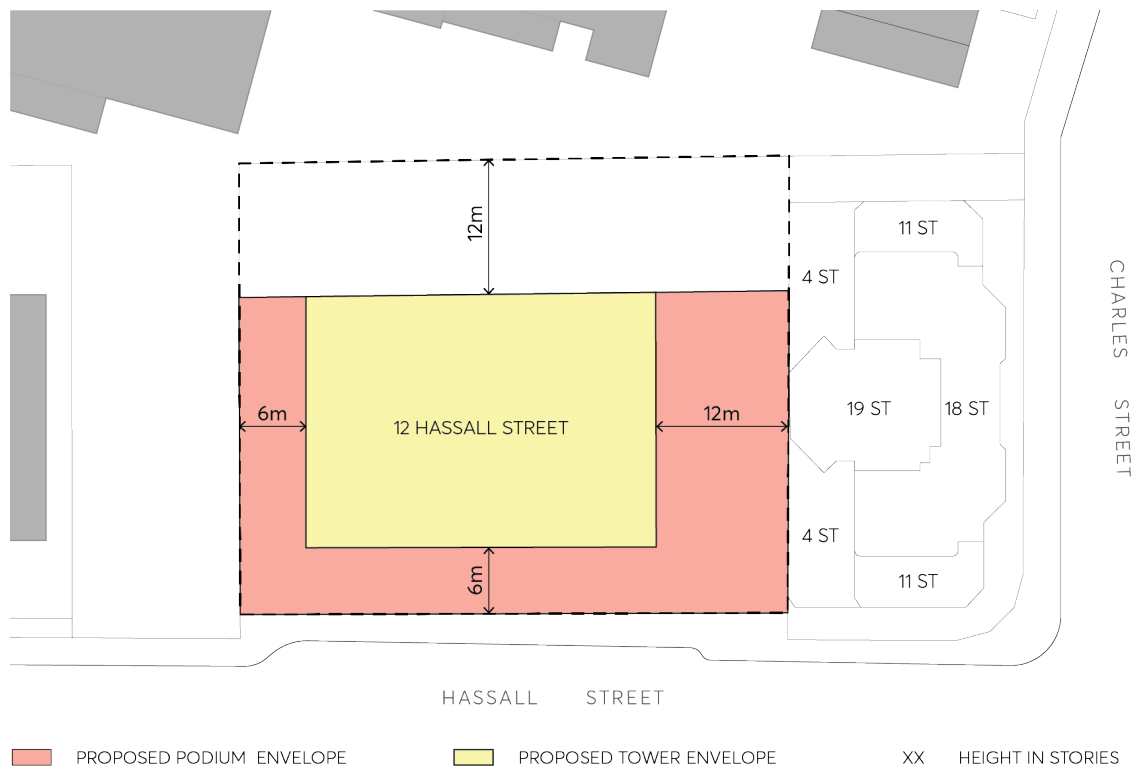

Figure 9.10.13.2 – Built form – setbacks and tower separations

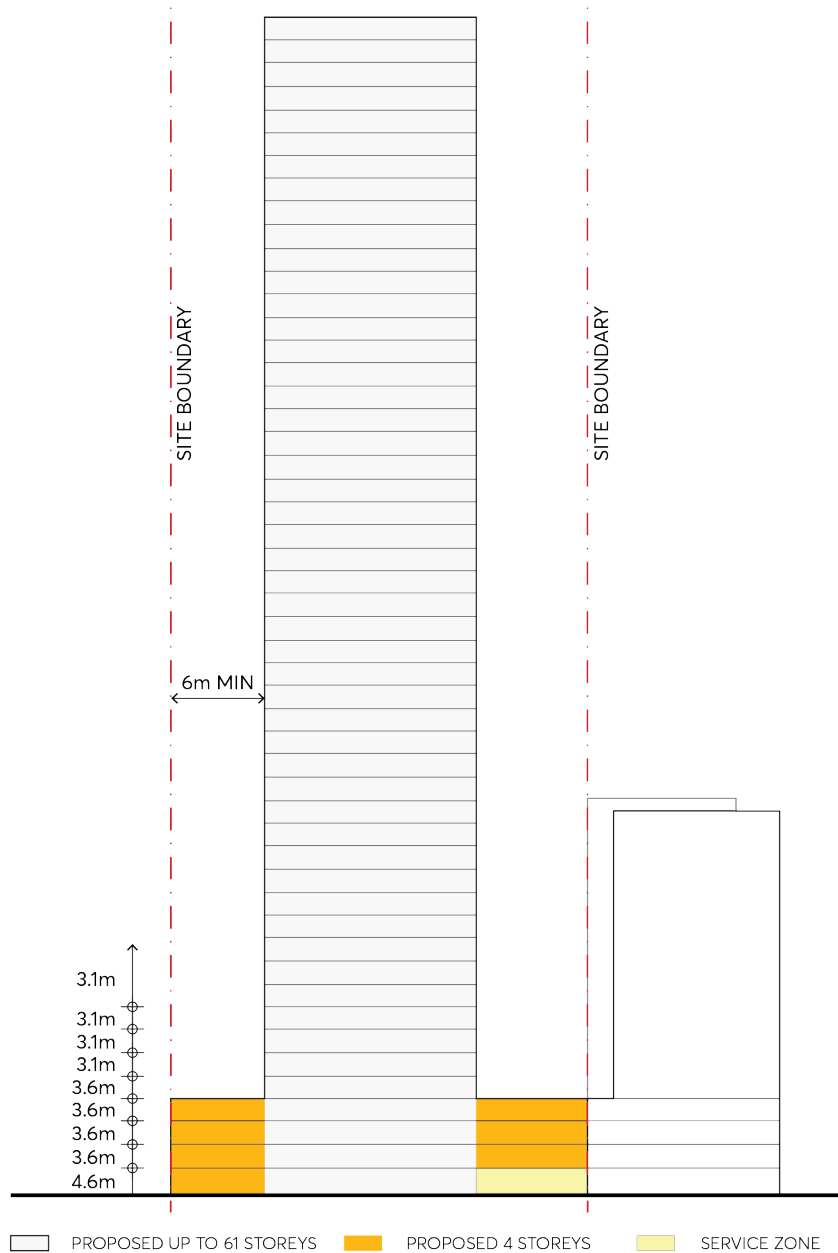

Figure 9.10.13.3 – Built form Elevation and floor to floor heights

9.10.13.3 MIXED USES

A mix of uses shall be provided within the building to complement that character of the Parramatta City Centre. The podium shall contain a mix of retail, commercial and consideration be given to community uses that will assist in activating the ground level. Residential uses shall be located within the tower to maximise amenity for future residents.

Objectives

- O.01 Activate the Hassall Street frontage to enhance public safety and increase pedestrian activity.
- O.02 Minimise potential conflicts between uses.

- O.03 Ensure the position of each use will maximise residential amenity and support non-residential uses.
- O.04 Ensure the building appropriately addresses and enhances the public domain.

Controls

- C.01 Ground level shall contain a mix of retail, food, and drink premises and/or business premises.
- C.02 Non-residential uses that activate the street shall be located along Hassall Street.
- C.03 Community facilities are encouraged and where provided should be located within the podium.
- C.04 The podium shall contain commercial floor space equivalent to a minimum of 1:1 floor space ratio.
- C.05 Residential floor space shall be located within the tower to maximise solar access.

9.10.13.4 PUBLIC DOMAIN AND LANDSCAPING

The development will improve the public domain with non-residential uses located at ground level. Improved pedestrian amenity will activate Hassall Street and create a place where people will interact to support the non-residential core of the City Centre. The ground level will be designed to enhance the environment along Hassall Street and provide pedestrian movement around the site and into the site to access non-residential uses at ground level.

Objectives

- O.01 To encourage pedestrian movement at street level along the street frontage to provide increased natural surveillance.
- O.02 Improve the natural environment to create a pleasant and desirable place to attract pedestrians and residents.

Controls

- C.01 Publicly accessible spaces should incorporate public art, seating and other facilities to enhance the space.
- C.02 The service zone shall be located adjacent to the eastern boundary to minimise conflict between vehicles and pedestrians, as shown in Figure 9.10.13.4 below.
- C.03 Street tree planting shall be provided along Hassall Street in accordance with the Parramatta City Street Tree Planting Policy.

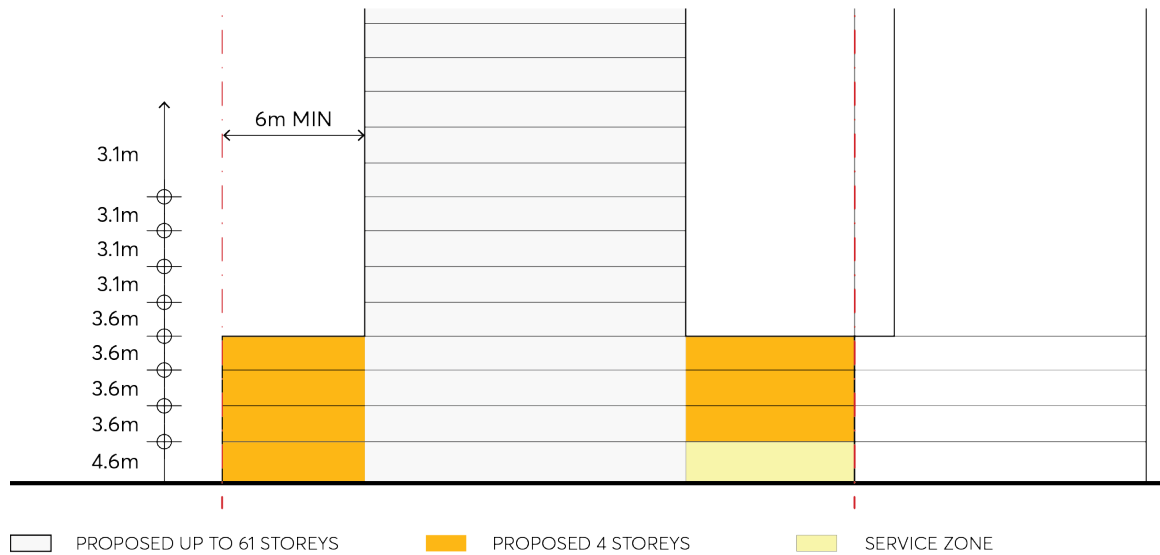

Figure 9.10.13.4 – Vertical view of the podium and service zone

9.10.13.5 CAR PARKING AND ACCESS

The access and movement throughout the site is characterised by both pedestrian and vehicular movement. It is vital to minimise conflict to maintain pedestrian safety.

Public and private access should be clearly defined and direction provided.

Objectives

- O.01 Minimise conflict between pedestrians and vehicle movements.
- O.02 Activate shared spaces and the public domain.
- O.03 Provide alternate private access for future residents directly to private open space.

Controls

- C.01 All vehicle/service vehicle access is to be via a driveway at the eastern end of the Hassall Street frontage.
- C.02 Vehicle and service access widths to be minimised and integrated into the building design without causing queuing of vehicles into the public domain.
- C.03 Car parking, loading and garbage areas are to be located within the basement levels.
- C.04 The shared area along the eastern boundary shall ensure that the vehicular and private pedestrian accesses are suitably separated to avoid conflict and maintain safety.
- C.05 Vehicles, including service vehicles, shall enter and exit the site in a forward direction.
- C.06 All loading and servicing need are to be catered for on-site and not rely on the surrounding kerbside on Hassall Street.

C.07 The design and location of vehicular access should minimise potential impacts to the operation of traffic signals at the intersection of Hassall Street and Chares Street.

9.10.14 20 MACQUARIE STREET

This Section applies to land at 20 Macquarie Street, Parramatta (formally described as Lot 1 DP 503651 and Lot 1 DP 501663) - the subject site - as illustrated in Figure 9.10.14.



Figure 9.10.14 – Land application map

This Section is to be read in conjunction with other sections of this DCP and the relevant provisions within *Parramatta LEP 2023*. If there is any inconsistency between this Section and other sections of this DCP, this section prevails.

This part establishes site specific principles, objectives and controls to be interpreted during preparation and assessment of development applications for the site.

The yield anticipated for the site via Clause 7.43 in *Parramatta LEP 2023* comprises:

- Base FSR of 10:1.
- Maximum building height of 90 metres.
- Design Competition Bonus of 15% relating to Height and FSR to achieve 103.5m and FSR of 11.5:1.

Note – This is subject to Clause 7.7 Sun access provisions in *Parramatta LEP 2023*).

This Section sets relevant development controls for the form of the building, taking into account the anticipated yield in floor space. This bonus height and FSR will be achieved via Part 7, Division 3 Design excellence in *Parramatta LEP 2023* at the Development Application stage.

Options for Development

The following Desired Future Character, Built Form, Design and Massing, Land Uses, Traffic and Transport Objectives can be presented for two development options, the options include:

- **Option A** – Retail and commercial uses on the lower floors and hotel and commercial uses above with underground parking below.
- **Option B** – Retail and commercial uses on the lower floors and residential uses above with underground parking below.

OPTION A – RETAIL, COMMERCIAL USES ON THE LOWER FLOORS AND HOTEL AND COMMERCIAL USES ABOVE WITH UNDERGROUND PARKING BELOW.

9.10.14.1 DESIRED FUTURE CHARACTER

Future mixed use development is consistent with the NSW Government policies to facilitate a renewed Parramatta City Centre.

The mixed use character of development is to complement the Parramatta City Centre and provides a positive design outcome. The proposed mix of land uses includes retail, commercial uses on the lower floors and hotel and commercial uses above with underground parking below.

The following design principles are incorporated into the future design of the building:

- Create a street wall which demonstrates design excellence and contributes to the design quality of space and streets in the City Centre;
- The street wall has been designed to provide a well-modulated pedestrian experience at street level. A smaller, more detailed scale is used in its articulation;
- The tower is designed to ensure solar protection to the key public spaces of Parramatta Square;
- Emphasis is placed on the corner position of the site compliant with this DCP section's objectives;
- The tower engages directly with the secondary street frontage;
- The development comprises a podium edge to Macquarie Street, with recessed tower form to minimise negative street amenity impacts, especially wind mitigation;
- Zero setback is provided to Marsden Street, with high quality (shingle) façade design to ameliorate negative street amenity impacts especially wind mitigation and quality design gestures is provided in the architectural skeleton;

- A Shingle Façade System is used to eliminate wind downdraft to Marsden Street;
- Incorporate a street wall and canopy to Macquarie Street;
- The ground floor facade is rich in variation and detail. Vertical relief in the façade is provided to maximise the walking experience, with awnings included and integrated in the design to provide adequate pedestrian shelter;
- The development provides an opportunity to attract a premier retailer to the high street, to transform Macquarie Street into a high-quality boulevard; and
- Development complies with the objectives and controls set out below and any other relevant objectives and controls of this DCP.

Site objectives

- O.01 To provide a mix of uses that support the role of Parramatta City Centre as Sydney's Central City.
- O.02 To revitalise Macquarie Street and Marsden Street.
- O.03 To encourage high quality built form outcomes and achieve design excellence.
- O.04 To minimise adverse impacts on the amenity of adjoining uses.
- O.05 To allow sunlight access to the key public spaces of Parramatta Square.

9.10.14.2 BUILT FORM, DESIGN AND MASSING

Objectives

- O.01 To ensure that the built form:
 - Responds positively to the subject site's location in relation to the Parramatta City Centre and the streetscape.
 - Has a positive and cohesive relationship with surrounding land and uses.
 - Has adequate separation to minimise visual bulk and to ensure adequate amenity within the site and to neighbouring development.
 - Achieves usable and pleasant street and podium environment in terms of daylight and solar access, scale, and wind mitigation.
 - Responds to the potential for future road widening on Marsden Street.

Controls

Street Frontage Heights

- C.01 Maximum street wall height of 14 metres (3 storeys) fronting Macquarie Street.

Building Setbacks

C.02 The minimum building setbacks are to be in accordance with the control table below:

Minimum setback (m ²)	
PODIUM	
All boundary (except Marsden Street)	0m for the first 3 storeys or any building up to 14m in height
Western boundary (Marsden Street)	
TOWER (UPPER LEVEL)	COMMERCIAL
Western boundary (Marsden Street)	2m
Eastern boundary	9m or 6m if criteria are met – see table below **
Northern boundary	6m
Southern boundary (Macquarie Street)	3m

Western boundary (Marsden Street) podium setback

C.03 The podium may overhang the 2 metres setback area, however, this will only be considered in the case that the proposed building satisfies the design excellence provisions within Part 7, Division 3 Design excellence in *Parramatta LEP 2023* and complies with the 2 metres setback for a maximum of 4.2 metres above the finished level of the future footpath as per Figure 9.10.14.4 – Section 2 through Marsden Street and Figure 9.10.14.5 – Detailed Section through Marsden Street.

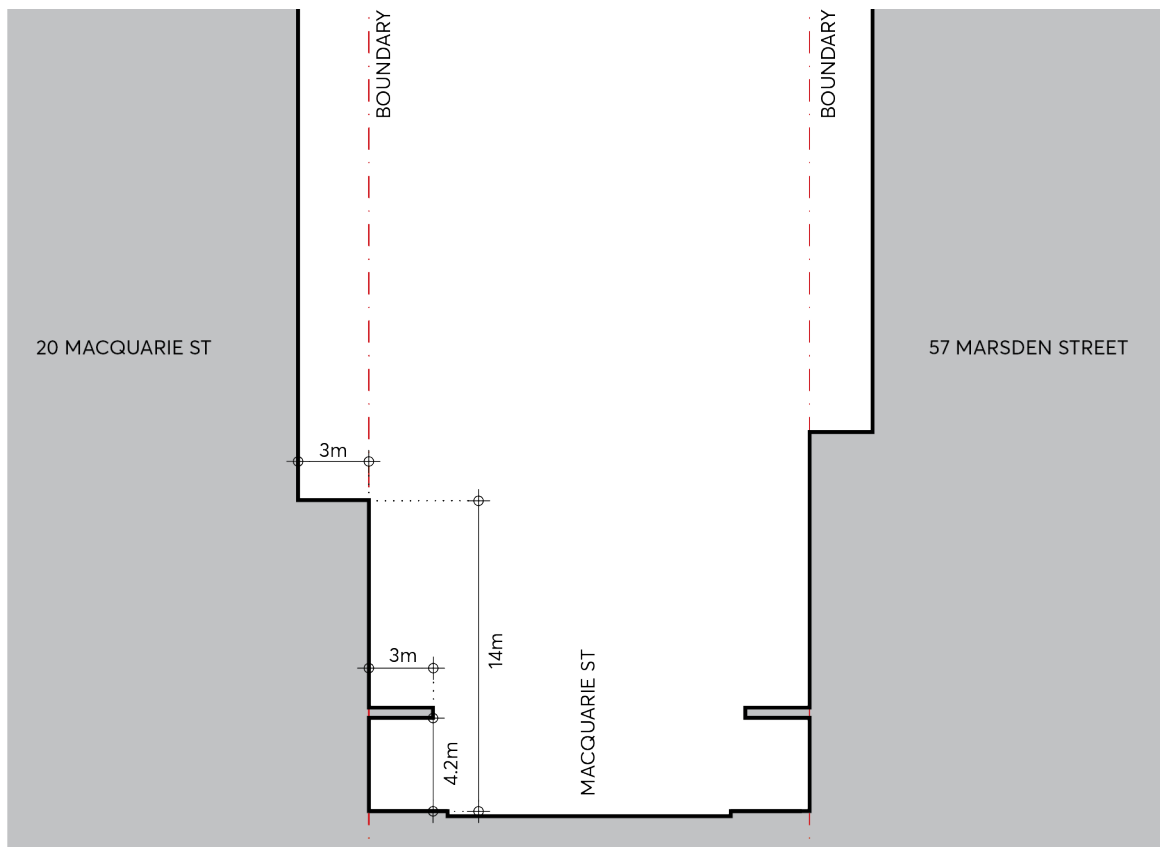

Figure 9.10.14.2 – Section 1 through Macquarie Street

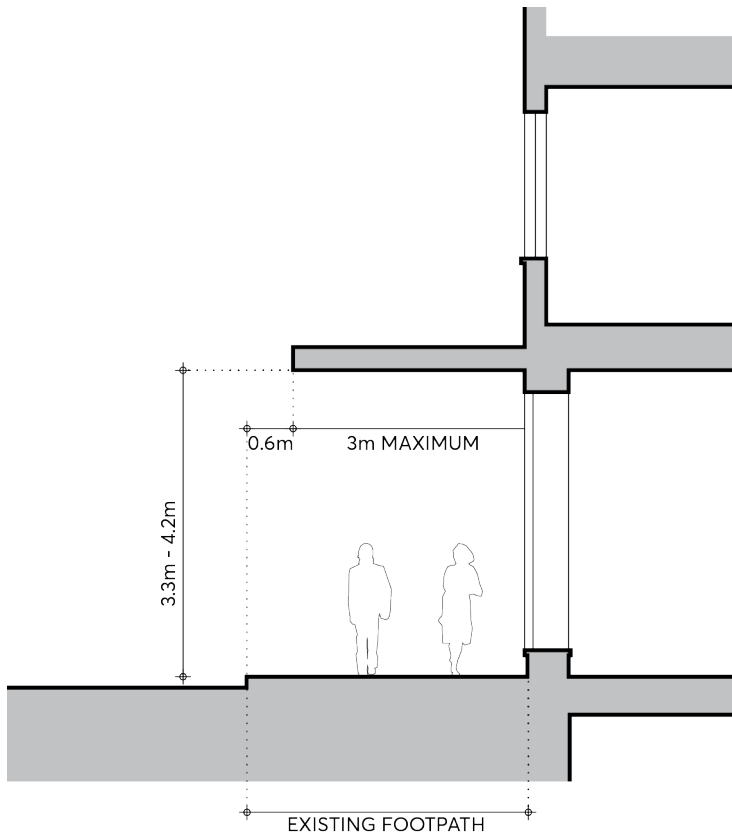

Figure 9.10.14.3 – Detailed Section through Macquarie Street

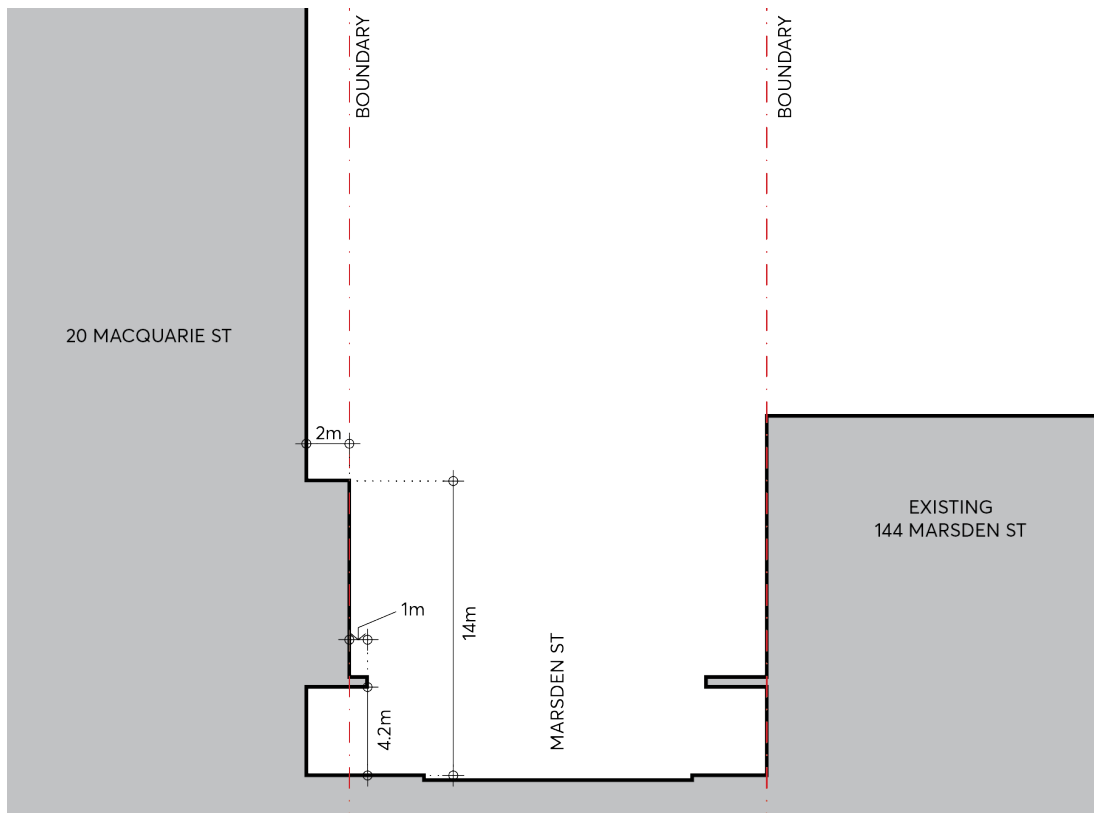

Figure 9.10.14.4 – Section 2 through Marsden Street

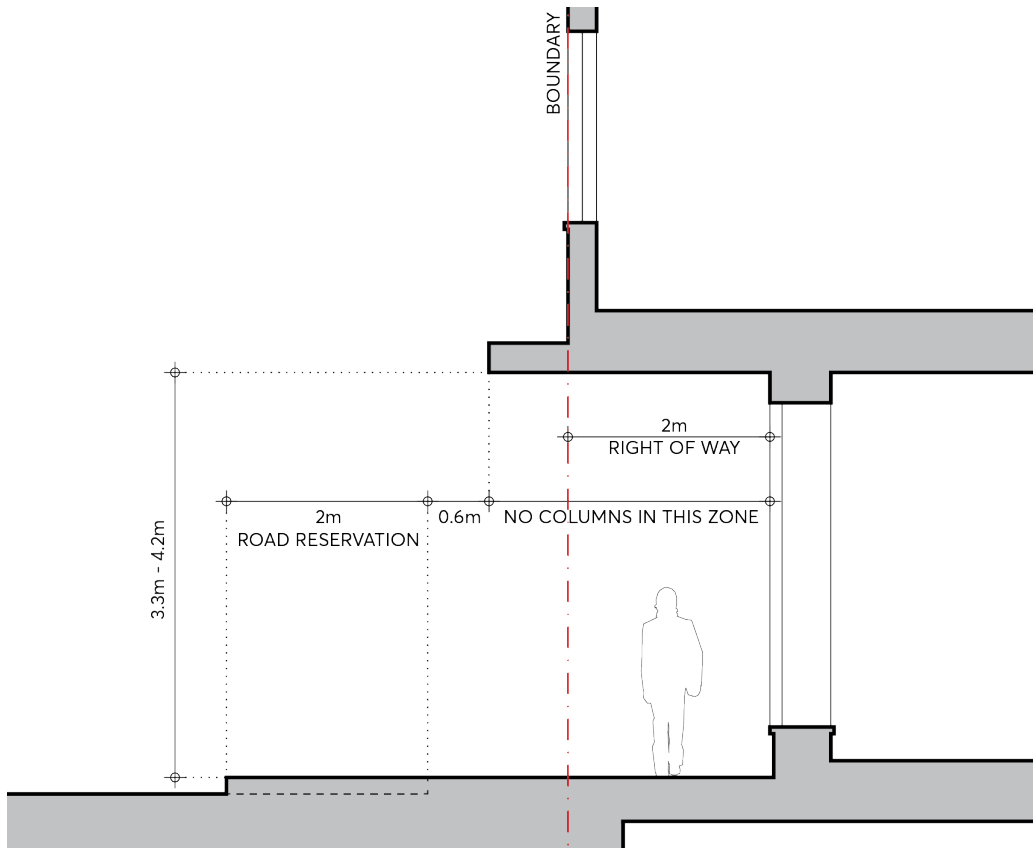

Figure 9.10.14.5 – Detailed Section through Marsden Street Tower (upper level) Eastern Boundary – 6 metre Minimum Setback Criteria

C.04 A lesser side setback on the eastern side boundary than 9 metres may be considered in the case that the proposed building satisfies the design excellence provisions within Part 7, Division 3 Design excellence of *Parramatta LEP 2023* and the following specific criteria in the control table below:

THEME	CONTROLS
Minimum side setback on the eastern boundary	The side setback is not less than 6 metres.
Minimum tower separation	The proposed tower is separated a distance of no less than 18m from any existing or proposed tower on the adjoining site to the east at 197 Church Street.
Public Domain Amenity	The proposed development ensures that the amenity of the public domain is retained and enhanced through adequate building separation such that: <ul style="list-style-type: none"> • Light can adequately penetrate between buildings. • Breezes can flow between buildings. • There are high quality and well-designed facades which can be seen and contribute to the visual amenity of the locality, the cityscape and beyond.
Design Quality	The proposed development achieves the highest level of design quality and design excellence such that it visually enhances the locality, the city scape and beyond.

THEME	CONTROLS
Visual privacy	The proposed development achieves building separation to ensure reasonable levels of external and internal visual privacy.
Internal amenity	The proposed development achieves a high level of internal amenity and can provide adequate access to light and ventilation.
Heritage	The proposed development does not have an unreasonable impact on the heritage significance of the heritage listed shop adjoining at No. 197 Church Street, Parramatta.

Tower floor plate

C.05 The tower setbacks will accommodate a tower with a floorplate of approximately 750m².

Building design

C.06 The street wall /podium is to be a separate architectural element, that is distinct and different in character from the tower element.

C.07 High quality design and materials are to be used for the security shutters into the car park and loading areas.

C.08 Should residential land uses be included, a vegetated rooftop terrace is to be provided in the podium that is usable taking into account solar access and wind mitigation.

C.09 Overshadowing is to be minimised within the area of Parramatta Square outlined in the blue hatched area of Parramatta Square identified as "No additional overshadowing" within the Sun Access Protection Map in *Parramatta LEP Plan 2023*. The building shall be designed so that no single point of the area identified above is in shadow between 12.00pm and 2.00pm in mid-winter.

9.10.14.3 LAND USES

Objectives

O.01 To provide for useable and functional floor space that can support the desired use, achieve internal spaces appropriate to their function and support the Parramatta City Centre.

Controls

C.01 The ground floor street frontage is used for active commercial uses.

C.02 Commercial/retail tenancies are of a sufficient size and layout to cater for their desired use and function.

9.10.14.4 TRAFFIC AND TRANSPORT

Objectives

- O.01 To ensure adequate parking is provided on site.
- O.02 To minimise pedestrian and vehicle conflict by locating vehicle access away from the Macquarie Street and Marsden Street intersection.
- O.03 To ensure parking design is integrated into the design of the building.

Controls

- C.01 Servicing, loading and set down/pick up activities are to be accommodated on site.
- C.02 Car parking is to be provided in accordance with the rates of parking prescribed in Clause 7.18 in *Parramatta LEP 2023*. Bicycle parking is to be provided in accordance with Section 6.3 – Bicycle Parking of this DCP.

OPTION B – RETAIL USES ON THE LOWER FLOORS AND RESIDENTIAL USES ABOVE WITH UNDERGROUND PARKING BELOW.

9.10.14.5 DESIRED FUTURE CHARACTER

Future mixed use development proposed at the site is consistent with the State Government policies to facilitate a renewed Parramatta City Centre.

The mixed use character of development complements the Parramatta City Centre and provides a positive design outcome. The proposed mix of land uses includes retail uses on the lower floors and residential uses above with underground parking below.

The following design principles are incorporated into the future design of the building:

- a street wall is created which demonstrates design excellence and contributes to the design quality of space and streets in the City Centre;
- the street wall is to be designed to provide a well-modulated pedestrian experience at street level. A smaller, more detailed scale should be used in its articulation;
- the tower is to be designed so as to ensure solar protection to the key public spaces of Parramatta Square.
- emphasise the corner position of the site compliant with the DCP objectives;
- comprise a podium edge to Macquarie Street and Marsden Street, with recessed tower form to minimise negative street amenity impacts, especially wind mitigation;
- the street wall to be designed to provide a well-modulated pedestrian experience at street level. A smaller, more detailed scale should be used in its articulation;
- incorporate a street wall and canopy to Macquarie Street;

- ground floor facade to be rich in variation and detail. Vertical relief in the façade to maximise the walking experience, with awnings included and integrated in the design to provide adequate pedestrian shelter;
- provide an opportunity to attract a premier retailer to the high street, to transform Macquarie Street into a high-quality boulevard;
- development is to comply with SEPP 65; and
- development is to comply with the objectives and controls set out below and any other relevant objectives and controls of this Section.

Site objectives

- O.01 To provide a mix of uses that support the role of Parramatta City Centre.
- O.02 To revitalise Macquarie Street and Marsden Street.
- O.03 To encourage high-quality built form outcomes and achieve design excellence.
- O.04 To minimise adverse impacts on the amenity of adjoining uses.

9.10.14.6 BUILT FORM, DESIGN AND MASSING

Objectives

- O.01 To ensure that the built form:
 - a) responds positively to the sites location in relation to the City Centre and the streetscape.
 - b) has a positive and cohesive relationship with surrounding land and uses.
 - c) has adequate separation to minimise visual bulk and to ensure adequate amenity within the site and to neighbouring development; and
 - d) achieves usable and pleasant street and podium environment in terms of daylight and solar access, scale, and wind mitigation.
 - e) responds to the potential for future road widening on Marsden Street.

Controls

Street frontage heights

- C.01 Maximum street wall height of 14 metres (3 storeys) fronting Macquarie Street and Marsden Street.

Building setbacks

- C.02 The minimum building setbacks are to be in accordance with the control table below:

Minimum setback (m)	
Podium	
All boundary (except Marsden Street)	0m for the first 3 storeys or any building up to 14m in height
Western boundary (Marsden Street)	2m
Tower (upper level)	
Residential	
Western boundary (Marsden Street)	6m
Eastern boundary	12m
Northern boundary	6m
Southern boundary (Macquarie Street)	3m

Western boundary (Marsden Street) podium setback

- C.03 The podium may overhang the 2 metres setback area, however, this will only be considered in the case that the proposed building satisfies the provisions in Part 7, Division 3 Design excellence in *Parramatta LEP 2023* and complies with the 2 metre setback for a maximum of 4.2 metre above the finished level of the future footpath as per Figures 9.10.14.4 and 9.10.14.5.

Tower floor plate

- C.04 The tower setbacks will accommodate a tower with a floorplate of approximately 600 square metres.

Building design

- C.05 The street wall/podium is to be a separate architectural element, that is distinct and different in character from the tower element.
- C.06 High-quality design and materials are to be used for the security shutters into the car park and loading areas.
- C.07 To ensure a landscape courtyard in the podium that is usable taking into account solar access and wind mitigation.

9.10.14.7 LAND USES

Objectives

- O.01 To provide for useable and functional floor space that can support the desired use, achieve internal spaces appropriate to their function and support the Parramatta City Centre.

Controls

- C.01 The ground floor street frontage is used for active commercial uses.
- C.02 Commercial/retail tenancies are of a sufficient size and layout to cater for their desired use and function.

9.10.14.8 TRAFFIC AND TRANSPORT

Objectives

- O.01 To ensure adequate parking is provided on site.
- O.02 To minimise pedestrian and vehicle conflict by locating vehicle access away from the Macquarie Street and Marsden Street intersection.
- O.03 To ensure parking design is integrated into the design of the building.

Controls

- C.01 Servicing, loading and set down/pick up activities are to be accommodated on site.
- C.02 Car parking is to be provided in accordance with the rates of parking prescribed in Clause 7.18 in *Parramatta LEP 2023*. Bicycle parking is to be provided in accordance with Section 6.3 – Bicycle Parking of this DCP.

9.10.15 197 AND 207 CHURCH STREET AND 89 MARSDEN STREET

This Section applies to land at 197 and 207 Church Street and 89 Marsden Street, Parramatta (197 Church Street) as illustrated in Figure 9.10.15. The subject land is formally described as Lot 1 DP 710335 and Lot 1 DP 233150.



Figure 9.10.15 – Land application map

This Section is to be read in conjunction with other sections of this DCP as well as with the relevant provisions in *Parramatta LEP 2023*. If there is any inconsistency between this Section and other Section of this DCP, this Section prevails.

This Section establishes objectives and controls to be interpreted for the preparation and assessment of any development application for the subject site and supports the objectives of *Parramatta LEP 2023*.

9.10.15.1 DESIRED FUTURE CHARACTER

The site occupies a significant corner within the Parramatta City Centre. The intersection of Church Street and Macquarie Street has historically played a major role in Parramatta's life as a city. The Greater Sydney Commission's Central City District Plan envisages that this vicinity of the City Centre will continue to play an important role as the unifying heart of the Central River City.

The City of Parramatta Council also foresees *a future for Parramatta as a centre of excellence... This means forward planning, innovation and investment to ensure that public infrastructure and future development meets the needs of our residents, visitors and worker*. This includes the redevelopment in and around Parramatta Square, the connection with Centenary Square and the provision of new Civic Link between the Parramatta River and Parramatta Square.

Future development at the subject site shall be designed to respond to the flood conditions of the site and surrounding roads.

Site Objectives

- O.01 Capitalise on the site's strategic location within the Parramatta City Centre.
- O.02 Facilitate the fine grain network of pedestrian links through the site.
- O.03 Respect the heritage items on the site and the social significance of these items.
- O.04 Ensure the built form outcome is appropriate, having regard to Council's and the community's vision for the Parramatta City Centre, and ensure the built form responds to the emerging built form context.
- O.05 Ensure development provides built form articulation and an attractive composition of building elements with an appropriate relationship between buildings and streetscape.
- O.06 Ensure building height is distributed across the site having regard for orientation and overshadowing.
- O.07 Provide opportunities for an appropriate level of active ground floor uses to be accommodated to increase pedestrian activity and use of public domain areas.
- O.08 Include stormwater management measures which appropriately address the level of flood affectation on the site and immediate surrounds.
- O.09 Ensure the design of the building addresses the local flood conditions and does not impede local overland flow paths.
- O.10 Minimise the risk to life by ensuring appropriate safe areas within the building to shelter during a flood, and safe access from the building during a medical or fire emergency.
- O.11 Allow uses and development on the site that are appropriate to the flood hazard.
- O.12 Facilitate redevelopment of the site as a high-quality mixed use development.
- O.13 Ensure the building interfaces positively with the public areas and contributes to an attractive public domain and desirable setting for its intended uses.

9.10.15.2 BUILT FORM

The reference design is a guide to future development on the site and is based on a proposal that provides for two towers above a podium which will cover the entire site. The tower on the south and eastern part of the site comprises commercial floor space. The tower on the north-western part of the site (fronting Marsden Street) comprises hotel accommodation.

Retail floor space may be provided on the ground floor of the podium, as well as within a lower ground/basement level, which has been designed to accommodate a small format supermarket. Site servicing (loading, unloading, waste collection) may also occur on basement level 1. Car parking will be located within basement levels accessed from Macquarie Street.

Objectives

The following design objectives are to be considered in relation to development on the site:

- O.01 Towers are to be designed to ensure solar access to the key public space within Parramatta Square is maintained.
- O.02 Activation of street frontages to Church Street, Macquarie Street and Marsden Street is to be provided.
- O.03 Opportunities to connect with the development on 20-22 Macquarie Street at ground level to be considered.
- O.04 The existing facade of the Murray Bros building along Church Street and Macquarie Street (including the awning) is to be retained. Access arrangements are to respect the heritage values of the facade.
- O.05 Incorporate design features to eliminate wind downdrafts on Marsden and Macquarie Streets.
- O.06 Provide awnings along all street frontages, where these can be incorporated without compromising heritage features.
- O.07 Provide opportunities to accommodate a major retail tenant within the ground floor or lower ground floor areas.

Controls

- C.01 The setbacks along Marsden Street are to be consistent with those shown in Figures 9.10.15.2 and 9.10.15.3.
- C.02 The parapet wall along Marsden Street is to align with the parapet height of the Marsden Street frontage of the adjoining development on 20 Macquarie Street. Refer Figures 9.10.15.2 and 9.10.15.3.

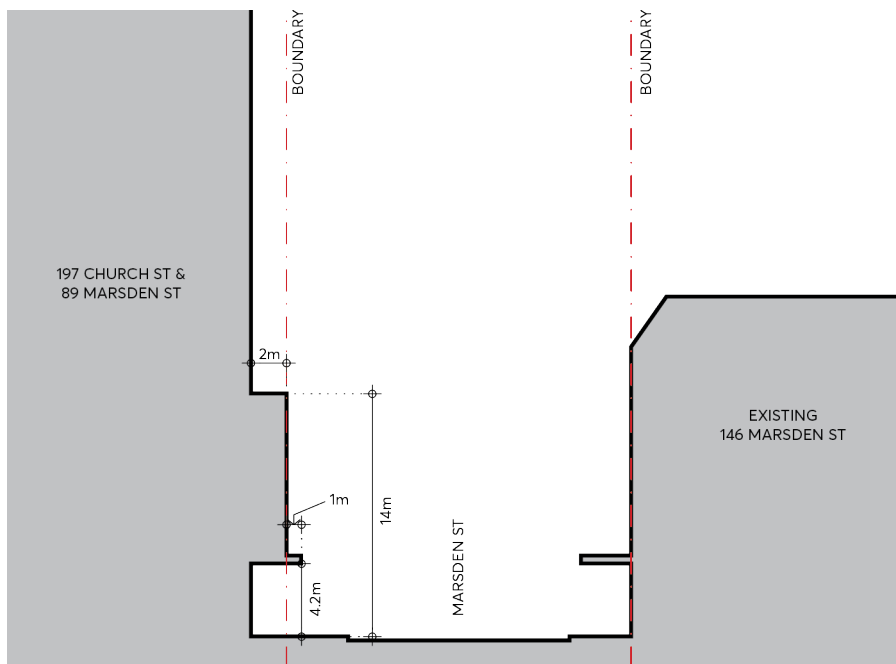

Figure 9.10.15.2 – Marsden Street Frontage – Setbacks to Podium and Tower

- C.03 A zero setback to Macquarie Street for the podium, with the tower element being setback a minimum of 6 metres to Macquarie Street.
- C.04 A zero setback to Church Street for the podium, with the tower element being setback a minimum of 12 metres from Church Street.
- C.05 The separation between towers used for non-residential uses on the site shall be a minimum of 12 metres.
- C.06 Setbacks to adjoining property boundaries will generally be a minimum of 6 metres for non-residential uses.
- C.07 If residential uses are proposed, setbacks to adjoining property boundaries will be a minimum of 9 metres, and inter-building separation of 18 metres between residential uses and compliant with the design criteria specified in Part 2F of the Apartment Design Guide.

Note – The above controls are illustrated on the Site Reference Site Plan at Figure 9.10.15.4.

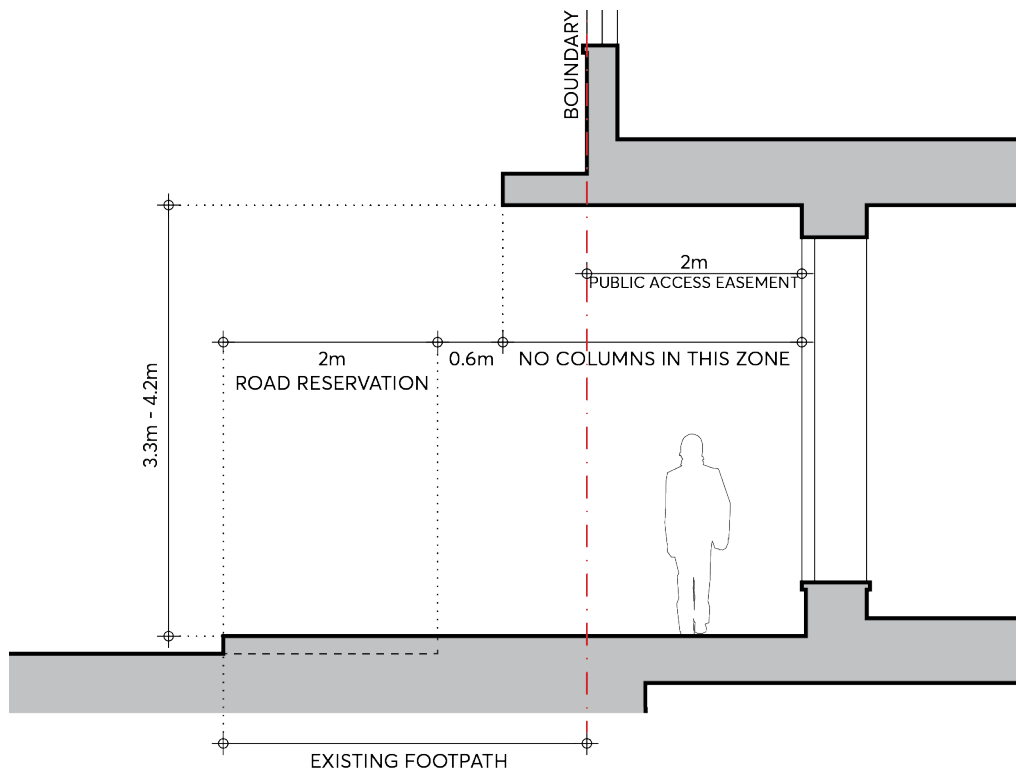

Figure 9.10.15.3 – Detailed Section through Marsden Street

9.10.15.3 PUBLIC DOMAIN

The fine grain pedestrian network is a key aspect of the public domain. The pedestrian amenity provisions in this section are intended to achieve a high quality of urban design, pedestrian comfort and safety in the City Centre.

Parramatta's streets, lanes, arcades and through-site links should form an integrated and legible pedestrian network providing choice of routes at ground level for pedestrians. The design of individual developments will be required to contribute to and integrate with this network.

The site offers an opportunity to enhance the public domain by the provision of through-site pedestrian links to and from key destinations within the City Centre.

Objectives

The following design principles are to be considered in relation to public domain features within any future development:

- O.01 Improve access within and through the City Centre by providing new through-site links.
- O.02 Contribute meaningfully to the legibility of the pedestrian network.
- O.03 Provide active frontages to through-site links.
- O.04 Design through-site links having regard to pedestrian amenity and safety.
- O.05 Design to separate vehicular entries from primary pedestrian thoroughfares.

Controls

- C.01 A through-site pedestrian link from Church Street to Marsden Street is to be incorporated.
- C.02 A through-site pedestrian link from Macquarie Street to the Church Street/Marsden Street through-site link is to be provided.
- C.03 Arcades must be located in a mid-block position or where connections can be made between other public spaces as agreed with Council.
- C.04 Arcades must not compromise, or take precedence over, the activation of adjacent streets.
- C.05 Where possible, arcades must be aligned with existing arcades or laneways across blocks.
- C.06 Arcades must provide clear access and sight lines from one end to the other and be designed so as to:
 - a) Be well-proportioned with a minimum width of 4 metres and minimum ceiling height of 4.5 metres.
 - b) Have a 1:20 maximum gradient.
 - c) Connect one public space to another in a clear and obvious way.
 - d) Act as a supplementary connection rather than a primary one.
 - e) Conform to the relevant controls relating to active ground floor frontage contained elsewhere in this Section.

Note – The above controls are illustrated on the Site Reference Site Plan at Figure 9.10.15.4.

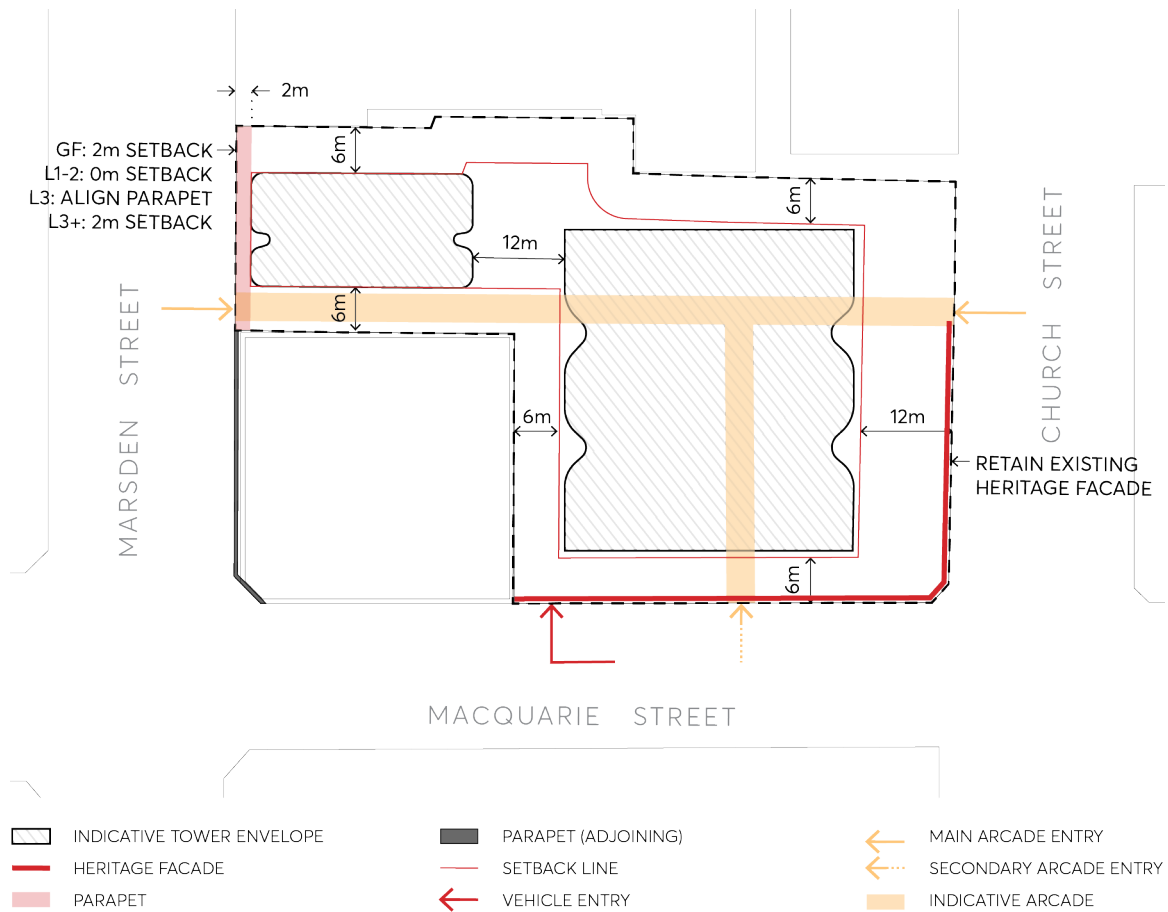

Figure 9.10.15.4 – Site Reference Plan and Footprint

9.10.15.4 TRAFFIC AND TRANSPORT

The site is ideally located to take advantage of existing and future public transport options including heavy rail and light rail. In light of this, a reduction in the provision of on-site car parking can be considered.

Objectives

- O.01 Ensure adequate parking is provided.
- O.02 Discourage reliance on private vehicles.
- O.03 Minimise pedestrian and vehicle conflict and flooding impacts.
- O.04 Ensure parking design is integrated with the design of the building.

Controls

- C.01 Provide car parking, on site loading and bicycle parking in accordance with Part 6 – Traffic and Transport of this DCP.
- C.02 Loading/unloading facilities are to be designed to facilitate efficient use of dock areas.

C.03 All loading and servicing parking, vehicle set down/pick up for point-to-point transport and bus/coach and bus/coach layover parking of adequate capacity to accommodate the demand of the development, is to be located within the site in accordance with the RTA Guide to Traffic Generating Developments.

Note – A control relating to vehicle access has not been included as access arrangements are still to be determined. However, Council's current policy position on this matter is to support vehicle access arrangements whereby vehicles enter from Macquarie Street and exit onto Marsden Street, noting the following:

- a) This position should form the basis of assessment of this matter for any Design Competition or DA at the site.
- b) The matter of vehicle access at the site will be re-exhibited as part of the draft Parramatta City Centre DCP, or a DA at this site, whichever comes first.

9.10.15.5 HERITAGE

The site contains listed heritage items. There are also a number of heritage items in the vicinity of the site. There is also the potential for archaeological items to be found on the site.

Objectives

- O.01 The existing facade of the Murray Bros building along Church Street and Macquarie Street (including the awning) is to be retained.
- O.02 Opportunities to incorporate existing heritage fabric is to be considered.
- O.03 Creation of new access arrangements will seek to minimise impacts on the heritage facade.
- O.04 Acknowledge heritage items to the north of the site and across Church Street, the heritage view corridor along Church Street, and the broader context of Centenary Square.
- O.05 Opportunities to conserve local and State significant archaeological items are to be considered.

Controls

- C.01 The recommendations detailed in the Rappoport Heritage Consultants Statement of Heritage Impact dated March 2015 are to be incorporated during the detailed design.
- C.02 An archaeological assessment will be prepared for the site and the recommendations of the assessment incorporated into the detailed design. This includes the conservation of local and State significant archaeology. Where this is not possible or practical, excavation, salvage, reuse and/or interpretation of the archaeology in accordance with an approved archaeological research design and excavation methodology is to occur.

9.10.15.6 STREET WALL DESIGN

Objectives

- O.01 Define the space of the streets and articulate their edges.
- O.02 Design the street walls to provide appropriate scale and detail.
- O.03 Design the street walls to achieve fine grain modulation in the street.
- O.04 Provide comfort and shelter for pedestrians.
- O.05 Minimise large expanses of inactive frontage.

Controls

- C.01 The street walls must:
 - a) Be modulated in vertical increments that relate to the fine grain subdivision pattern of the surrounding context.
 - b) Be of predominantly masonry character with limited amounts of glass and no lightweight panel construction.
 - c) Be articulated with depth, relief and shadow on the street facade. A minimum relief of 150mm between the masonry finish and glazing face must be achieved.
 - d) Use legible architectural elements and types – doors, windows, loggias, reveals, pilasters, sills, plinths, frame and infill, etc – not necessarily expressed in a literal traditional manner.
 - e) Include semi-recessed awnings for pedestrian shelter (refer to Figure 9.10.15.3).
 - f) Include a ground floor facade design which intensifies the walking experience with particular richness in detail.
- C.02 Under crofts or disruptions of the street wall which expose the underside of the tower and amplify its presence on the street are not permitted.

9.10.15.7 GROUND FLOOR

Objectives

- O.01 Provide for the amenity, interest, and liveliness of the pedestrian street environment.
- O.02 Ensure a positive experience for pedestrians with a fine grain environment of the street.
- O.03 Integrate an engaging street interface with the design of the public domain, taking account of the context of the site.
- O.04 Optimise the extent of active frontages in the public domain.
- O.05 Ensure appropriate scale and proportion of foyers and lobbies in relation to site frontage.

- O.06 Promote activity, connectivity, and variety in the public domain.
- O.07 Contribute to the economic vitality of the City.
- O.08 Ensure security measures do not inhibit passive surveillance on the street.

Controls

- C.01 The ground floor frontage should have active uses for a minimum of 70% of its length.
- C.02 Semi-recessed awnings must be provided on Marsden Street frontage (refer to Figure 9.10.15.3).
- C.03 The public domain on O'Connell Street to acknowledge the needs of Parramatta Light Rail Stage 1.
- C.04 Double height awnings are not permitted.
- C.05 Glass awnings are not permitted.
- C.06 The ground floor frontage must be designed in detail and the following must be incorporated in its design:
 - a) The ground floor levels, and facade structure and rhythm, must be designed to present a fine grain street frontage.
 - b) A nominal 500mm interface zone at the frontage should be set aside to create interest and variety in the streetscape, to be used for setbacks for entries, opening of windows, seating ledges, benches, and general articulation.
 - c) The frontage must have a high level of expressed detail and tactile material quality.
 - d) Facades must be vertically articulated.
 - e) The modulation and articulation of the facade should include a well resolved meeting with the ground plane that also takes account of the slope. A horizontal plinth integrated in the design must be incorporated at the base of glazing to the footpath.
 - f) The frontage must take account of the need to provide a clear path of travel for disabled access.
 - g) Legible entrances must be formed in the frontage.
 - h) Fire escapes and services must be seamlessly incorporated into the frontage with quality materials.
- C.07 Security doors or grilles must be designed to be:
 - a) fitted internally behind a shopfront;
 - b) fully retractable; and
 - c) a minimum 50% transparent when closed.
- C.08 Parking security grilles or doors must be recessed and aligned to the building edge.
- C.09 The frontage must not have deep recesses for entry lobbies that compromise safety.

9.10.15.8 FLOOD MANAGEMENT

Objectives

- O.01 Ensure the design of the building addresses the local flood conditions and does not impede local overland flow paths.
- O.02 Minimise the risk to life by ensuring appropriate safe areas within the building to shelter during a flood, and safe access from the building during a medical or fire emergency.
- O.03 Allow uses and development on the site that are appropriate to the flood hazard.
- O.04 Facilitate redevelopment of the site as a high-quality mixed use development.
- O.05 Ensure the building interfaces positively with the public areas and contributes to an attractive public domain and desirable setting for its intended uses.

Controls

Building Footprint and Uses

- C.01 DA submission requirements must include architectural design details for the landscaped open space and its interface with the building that:
 - a) have regard to the immediate flooding environment, including flooding both from Parramatta River and from local overland flow;
 - b) have regard to the [Parramatta Public Domain Guidelines](#);
 - c) have regard to the City of Parramatta's Council's Document: Best Practice Urban Design in Flood Prone Areas; and
 - d) are to the satisfaction of the Design Excellence Jury.
- C.02 Any development application must be supported by an adequate overland flow flood study satisfactory to Council from which the 1% AEP flood levels for overland flow may be determined. The Flood Planning Level (FPL) is the higher of either the Council adopted 1% AEP flood water surface level plus 0.5m freeboard from Parramatta River flooding, or the overland flow flood level as agreed by Council, plus 0.5m freeboard. It is probable that the FPL will vary around the perimeter of the site corresponding to the various applicable 1% AEP flood levels at each location. The architectural design must reflect this variation.
- C.03 The habitable floors of all residential uses within the building must be above the Probable Maximum Flood (PMF) for Parramatta River flooding as adopted by Council for this site. No freeboard is required for the PMF.
- C.04 'Sensitive Uses and Facilities' and 'Critical Uses and Facilities' as defined in Table 5.1.1.1, Section 5.1.1 – Flooding of this DCP are not permitted within the building.
- C.05 Basement car parking is discouraged but may be permitted subject to satisfying the requirements set out below.

- C.06 Loading docks, garbage transfer areas, plant rooms, bicycle storage plus end of trip facilities, storage of low value items and other non-habitable uses may be permitted below the FPL subject to the following safeguards.

Building and Basement Design

- C.07 To minimise the chance of a fire during a flood situation, the building must have a fire management system which meets the Australian Building Code Board (ABCB).
- C.08 External fire doors must be located above the FPL.
- C.09 The following details must be included as a minimum in the DA (Submission of this material will not necessarily result in Council approving basement car parking or the DA):
- a) Demonstrate that high hazard floodwaters will not occur in a 1% AEP event in the area adjacent to the driveway.
 - b) The basement must be protected from the ingress of floodwater by passive measures at least up to the FPL. These measures are likely to include provision of a driveway crest at or above the FPL with associated wing / or bund walls to this level to prevent floodwaters flowing into the basement.
 - c) The basement must be protected from the ingress of floodwater via the driveway up to the Probable Maximum Flood (PMF) level for Parramatta River. These measures are likely to include provision of a self-triggering and self-powered flood gate at or near the driveway crest that reaches the level of the PMF, together with corresponding wing wall bunds etc. to the same PMF level.
 - d) The basement must be protected from the ingress of floodwater via stairwells and other openings up to the PMF level. These measures are likely to include a combination of a self-closing flood doors, flood gates and bund walls. Flood doors may be combined with fire doors.
 - e) Provision of flood-free escape stairs from the basement up to a place of refuge/ shelter in place within the building above the PMF level with adequate facilities for users during and after a flood.
 - f) Provision of adequate car parking for the disabled and an escape path that can be followed to safety.
 - g) Submission of a comprehensive Flood Emergency Management Plan incorporating all of the above.
- C.10 Wherever possible, critical services infrastructure that could be damaged by flooding such as electrical, lifts, sewer and water are to be placed above the PMF level, or, where that cannot reasonably be achieved, effectively floodproofed.
- C.11 DA submission requirements must:
- a) Demonstrate that the building and basement will be protected from floodwaters up to the PMF.
 - b) Include evidence demonstrating why all or some of the critical infrastructure services cannot be located above the PMF and the floodproofing measures to be taken instead.

Areas of Refuge and Evacuation Routes

- C.12 All building occupants (residents, workers and visitors) must have access to a safe area of refuge or 'shelter in place' above the PMF where they can remain until the flood event has passed and any subsequent disruption after the flood has been rendered safe and serviceable. Residents may choose to remain in their own apartments as a safe area of refuge. A communal safe area(s) of refuge for residents, workers and visitors must also be provided and suitably equipped.
- C.13 A communal safe area of refuge must have emergency electricity supply, clean water, food, personal washing facilities, medical equipment including a first aid kit, a battery-powered radio and relevant communications equipment.
- C.14 All safe areas of refuge (residents own apartment or a communal area) must have:
- a) fail safe access from anywhere in the building including the basement (lift access is not allowed) that is protected from floodwaters up to the PMF by suitable flood doors, flood gates and the like; and
 - b) fail safe access to an exit/entry point located above the 1% AEP flood level plus 0.5m freeboard that enables people to exit the building during a fire and/or flood, and allows emergency service personnel to enter a building to attend to a medical emergency.
- C.15 DA submission requirements must include a Flood Emergency Management Plan (FEMP) consistent with that for the City Centre. The FEMP must outline:
- a) both warning and evacuation measures for occupants in the building including the most appropriate 'safe areas' and 'safe evacuation routes';
 - b) measures to prevent evacuation from the site by private vehicle;
 - c) the most appropriate emergency response for flood and fire events that occur together;
 - d) a building flood emergency management plan, similar to a building fire evacuation drill, and measures to ensure this is tested at least annually; and
 - e) consultation undertaken with relevant state and local agencies in the preparation of the FEMP.
- C.16 The Building Management System and Plan for the development must include all necessary measures to maintain, test and operate the flood protection devices including flood gates, doors and barriers, flood sensors, flood refuges and FEMP. Details of this will be required to support any DA.

9.10.16 18-40 ANDERSON STREET

This Section applies to 18-40 Anderson Street, Parramatta. The site comprises Lot 20 DP792518 which flanks the western side of Jubilee Park as shown in Figure 9.10.16.



Figure 9.10.16 – Land application map

This Section must be read in conjunction with other sections of this DCP and the relevant provisions in *Parramatta LEP 2023*. If there is any inconsistency between this Section and other Sections of this DCP, this Section prevails.

9.10.16.1 DESIRED FUTURE CHARACTER

The site is redeveloped into a high-quality mixed-use development with potential for hotel, residential and ground floor retail uses. Future development responds to the site's unique characteristics as a flood-prone site fronting Jubilee Park by providing appropriate stormwater and flooding management and minimising overshadowing to the park.

An improved public domain is a key component of future development. The site provides a pedestrian link along its eastern boundary with connection to Jubilee Park and a new public park for passive recreation, which will contribute to the walkability and amenity of the immediate locality.

Site Objectives

- O.01 To create a high-quality urban environment that provides a mix of uses including hotel, commercial and high density residential.
- O.02 To allow for viable hotel and residential floor plates while ensuring that built form responds to site constraints related to flooding, overshadowing and tree protection.
- O.03 To improve the quality and function of the public domain through provision of new pedestrian links and new park for passive recreation.
- O.04 To minimise overshadowing to Jubilee Park.
- O.05 To protect the mature fig trees in the northern portion of the site.
- O.06 To encourage activation of the street and public domain.
- O.07 To enable adequate flood conveyance and management while providing for the embellishment of portions of the Clay Cliff Creek corridor.
- O.08 In the case that two vehicle crossings over the footpath to access basements and service areas are unavoidable, to create a place for pedestrian respite when negotiating the two vehicle crossings, that also accommodates street trees within the respite space, without impeding the view of oncoming traffic.

Site Controls

Public Domain and Landscaping

- C.01 Provide a 3 metre-wide public pedestrian access path along the eastern boundary of the site as identified in Figure 9.10.16.2. The path should include a pedestrian bridge over Clay Cliff Creek connecting to Jubilee Park in the location identified in Figure 9.10.16.3.
- C.02 Provide a public park in the south of the site as identified in Figure 9.10.16.2. The park should be designed to cater for passive recreation and to minimise flood flow obstructions. The park should also provide a continuous tree canopy between Jubilee Park and Anderson Street.

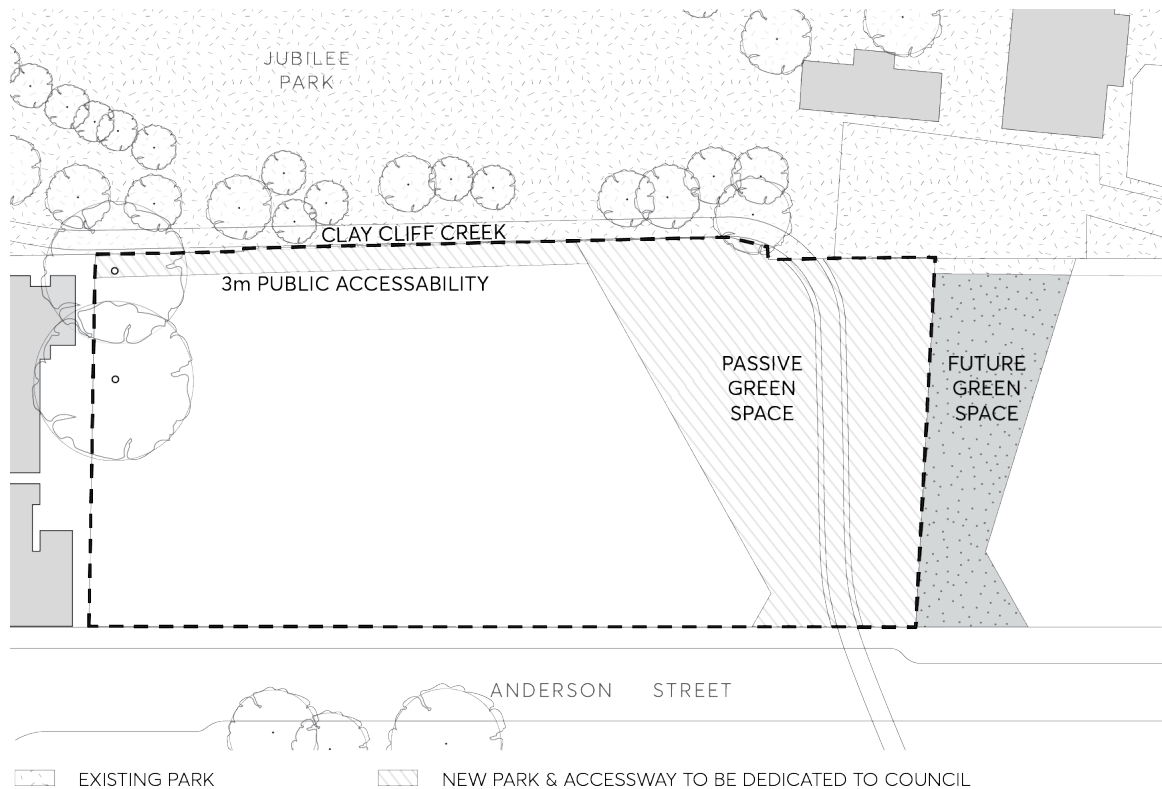

Figure 9.10.16.2 – Public domain plan

- C.03 Public pathways that are named with street signage, lighting and street address are to be provided along the Jubilee Park interface and the park to the south. Development should be designed to address, and provide an accessible and public interface to, the pedestrian access path and southern park identified in C.01 and C.02.
- C.04 Landscaping is to reflect the level of solar access through the site. Shade tolerant species and permeable hard surfaces are to be used in heavily shaded areas.
- C.05 Provide an active frontage along Anderson Street. Active frontage is defined as one or a combination of the following at street level:
- Retail premises or business premises with entry from the street.
 - Active office uses, such as reception, if visible from the street.
 - Glazed lobby entries.
- Areas for vehicular access are excluded from this requirement.
- C.06 Minimise the extent of vehicular access presenting to the street. Access is to be limited to a porte-cochere and a single two way entry point off Anderson Street for both hotel and residential uses. The vehicular entry should be discrete and recessive. Façade materials should be applied to the interior of vehicular entries.
- C.07 Design of the raised pedestrian lane and pedestrian connection as per Figure 9.10.16.3 must meet the following requirements:

- a) Be raised above the 1% flood level, as per Council's Flood Engineers advice, using retaining walls design to withstand flood effects. Special consideration and horticultural advice should be applied when designing and constructing the footway within the Tree Protection Zone (TPZ) of the adjacent *Ficus* trees.
- b) Align with building ground floor and provide for and ensure 24/7 safe public accessible access within the building during an emergency flood period.
- c) Meet existing ground level using footway graded no steeper than 1:20 (V:H), steps and ramps should be avoided. The raised footway must provide access to existing ground level beyond the 1% flood extent, to allow emergency evacuation if required.
- d) Design and material selection of the raised footway and associated hardware ie railings, be commensurate to a 24/7 publicly accessible space, to be of high quality and standard of finish, and that the building design compliment.
- e) Lighting should be provided from the building and avoid light spill into the adjacent park spaces.

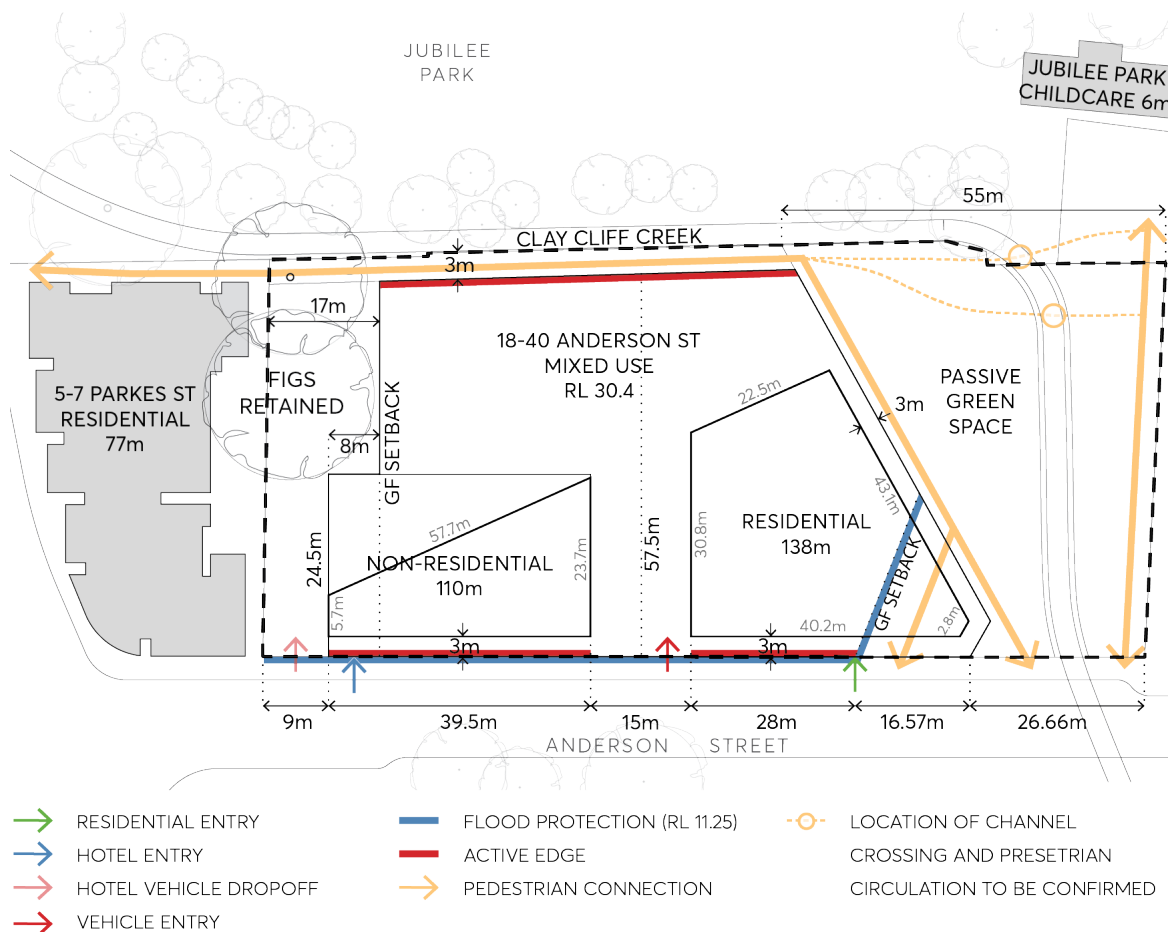

Figure 9.10.16.3 – Land use plan

C.08 Use of space within the setbacks associated with the Fig trees must ensure the long-term viability and sustainability of the fig trees. An Arboricultural Impact Assessment and Tree Protection Plan must be provided prior to any design, prior to construction and post

construction. The report must also include recommendations to reuse and transplant existing vegetation such as the palms.

- C.09 If two vehicle crossings over the footpath to access basements and service areas are unavoidable, they must be separated and there should be sufficient space between the vehicle crossings so that:
- a) The space between the vehicle crossings must be a minimum 4 metres to allow for the installation of CoP Street tree planting in StrataVault with Mass Planting detail, subject to Council advice.
 - b) This detail and surface finish of the tree pit may be modified to use a tree grate, subject to Council advice.
 - c) The vehicle crossing must be installed as per Council Heavy Vehicle detail DS9 or DS45, subject to Council advice.
 - d) The placement of the vehicle crossing should not impose on the overall dimensions and performance of the street tree(s) planter bed, subject to Council advice.

Building Envelope

C.10 Building heights must be consistent with the building envelopes in Figure 9.10.16.4 to Figure 9.10.16.9.

Note – additional height for the northern tower may be available through LEP provisions.

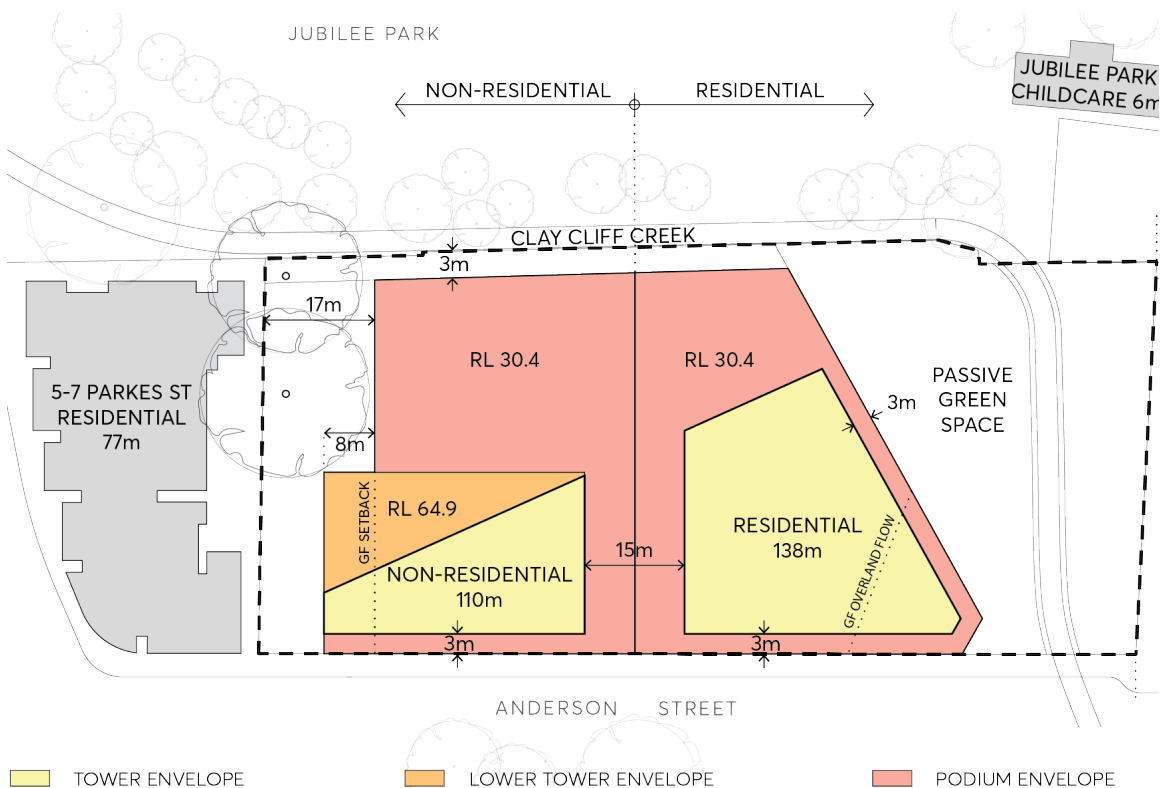

Figure 9.10.16.4 – Building envelope plan

- C.11 Building setbacks must be consistent with Figure 9.10.16.5 to Figure 9.10.19.10. Setbacks must be measured perpendicular to the boundary to the outer faces of the building including balconies, sunscreens, and the like.
- C.12 Provide a podium to a maximum height of RL 30.4 and 0m setback along Anderson Street and the new southern park (subject to C.16), with a minimum 3 metre setback above the podium.
- C.13 Provide a minimum 9 metres setback from the northern boundary for the northern tower and the western portion of the northern podium form as shown in Figure 9.10.16.5.
- C.14 Provide a minimum 17 metres setback from the northern boundary for that part of the podium adjacent to the mature fig trees, as shown in Figure 9.10.16.4.

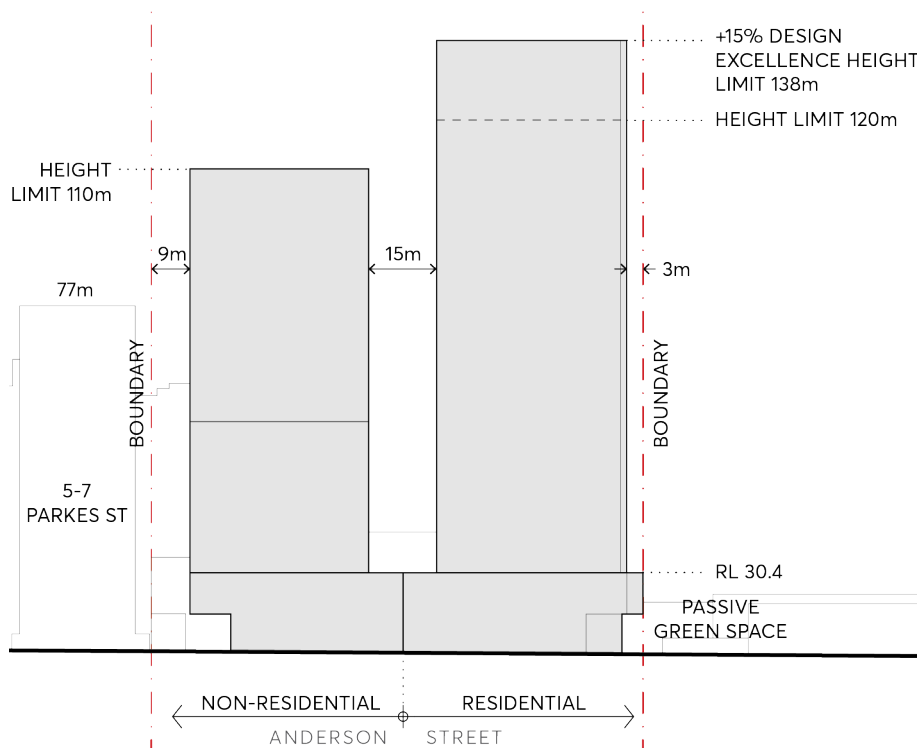

Figure 9.10.16.5 – Building envelope Anderson Street elevation

- C.15 Provide a minimum 15 metres of building separation between the commercial and residential tower forms within the site so that tower buildings appear ‘in the round’ as shown in Figure 9.10.16.5. The 15 metres setback is based on the northern hotel tower not having primary sources of light and ventilation to habitable uses located on the southern façade. Should habitable uses accessing light and ventilation be proposed on both sides of this setback, a minimum inter building separation of 18 metres must be provided.

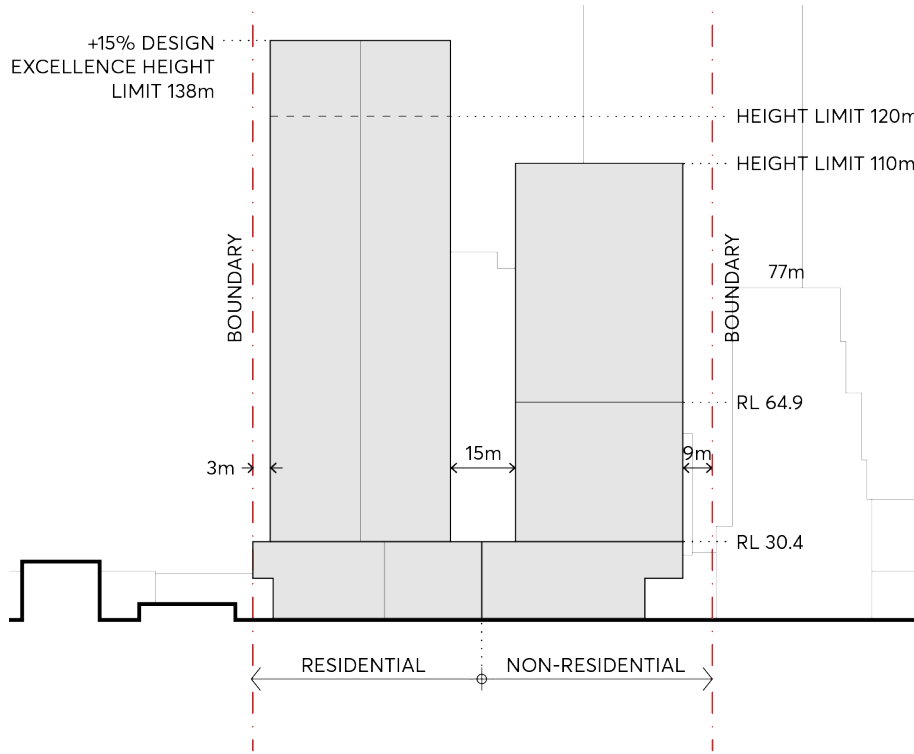

Figure 9.10.16.6 – Building envelope Jubilee Park elevation

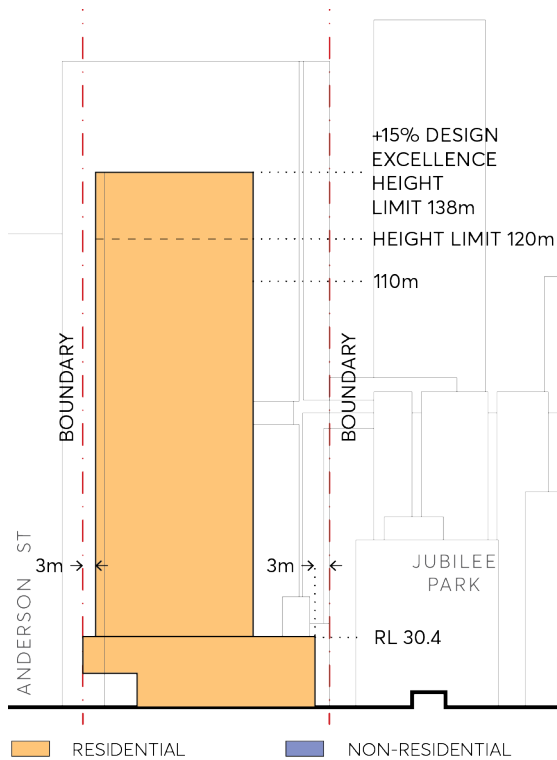

Figure 9.10.16.7 – Building envelope south elevation

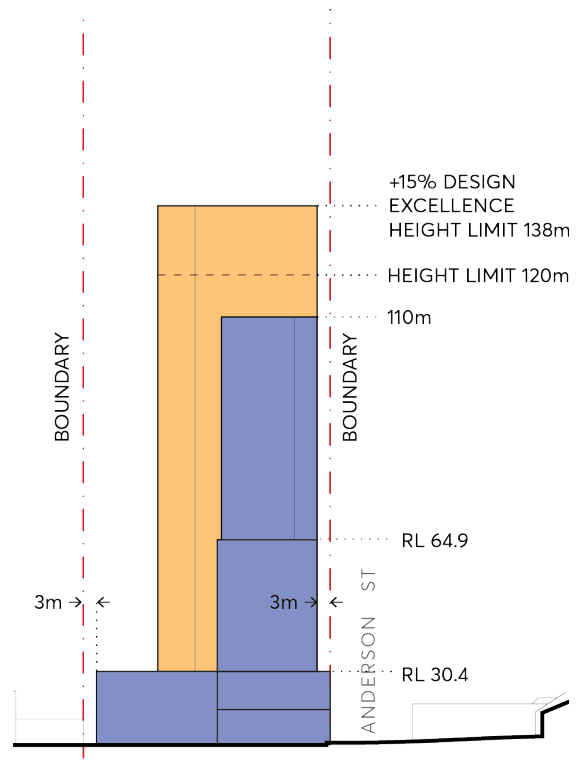

Figure 9.10.16.8 – Building envelope north elevation

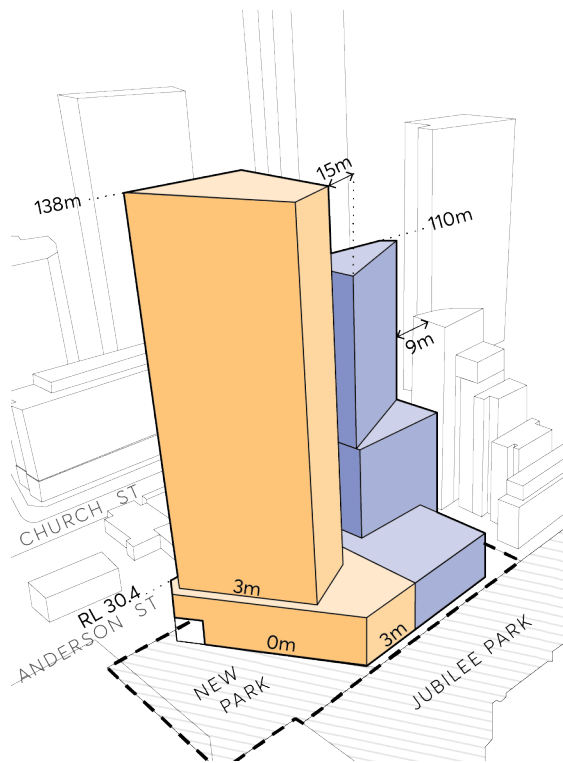

Figure 9.10.16.9 – Envelope perspective from south-east

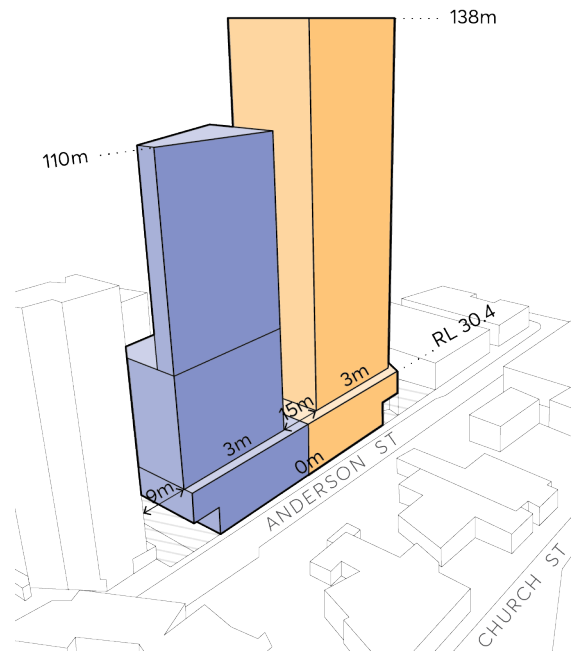

Figure 9.10.19.10 – Envelope perspective from north-west

- C.16 Development in the area identified as '1' on Figure 9.10.16.11 must not cause any additional overshadowing, on 21 June in any year, to Jubilee Park (shown hatched grey) between 12:00 and 14:00.



Figure 9.10.17.11 – Jubilee Park Sun Access Protection Map

Flooding and Stormwater Management

- C.17 Implement measures to convey floodwaters in the Clay Cliff Creek Corridor through the property such that development causes minimal adverse flooding impacts on adjoining properties during the 1% AEP event compared to existing conditions.
- C.18 Provide landscaping embellishments to the surroundings of Clay Cliff Creek on the eastern and southern sides of the development site and within the park in the southern end of the site in order to enhance the character of the creek environment. The landscaping should result in no adverse impacts on adjoining properties during the 1% AEP event compared to existing conditions.
- C.19 In order to achieve minimal adverse flooding impacts on adjoining properties in Anderson Street during the 1% AEP event compared to existing conditions, development must have a ground floor that is set back from the southwest corner of the site generally in accordance with Figure 9.10.16.4 to Figure 9.10.16.10. Any cantilever element above the setback (excluding any structural support columns or similar) must have a minimum 4 metre clearance above the ground surface level of the overland flow path.

Parking and Access

- C.20 A porte-cochere driveway entry may be provided if it is well integrated into the site layout and includes appropriate landscaping to improve the driveway’s interface to the public domain.

- C.21 All areas for vehicle passenger set down/pick up, car parking, loading, deliveries and servicing shall be located within the boundaries of the site.
- C.22 All vehicles, including service vehicles, shall enter and exit the site in a forward direction.
- C.23 In addition to the porte-cochere, a single two-way entry point off Anderson Street is permitted to serve both hotel and residential uses.

Architectural Resolution

- C.24 The northwest corner of the northern tower must be designed to recognise its prominent location at the viewpoint terminus for eastbound traffic along Great Western Highway. Emphasis should be placed on views to sky and visibility beyond as much as the building presentation. This aspect must be incorporated in any roof level signage if provided.
- C.25 The setback area at ground level required under Control C.11 must be expressed architecturally as an "urban room" with a positive interface to the adjoining public domain.
- C.26 A defined street wall with the towers set clearly back must be provided along all public interfaces to the east, south and west as per detailed sections shown in Figure 9.10.16.12, Figure 9.10.16.13 and Figure 9.10.16.14. This street wall must:
 - a) Be built to the street alignment at all levels along its full frontage except where identified for a porte cochere and flood conveyance.
 - b) Be modulated in vertical increments that relate to a traditional subdivision pattern.
 - c) Be of predominantly masonry character with limited amounts of glass and no lightweight panel construction.
 - d) Be articulated with depth, relief, and shadow on the street façade. A minimum relief of 150mm between the masonry finish and glazing face must be achieved.

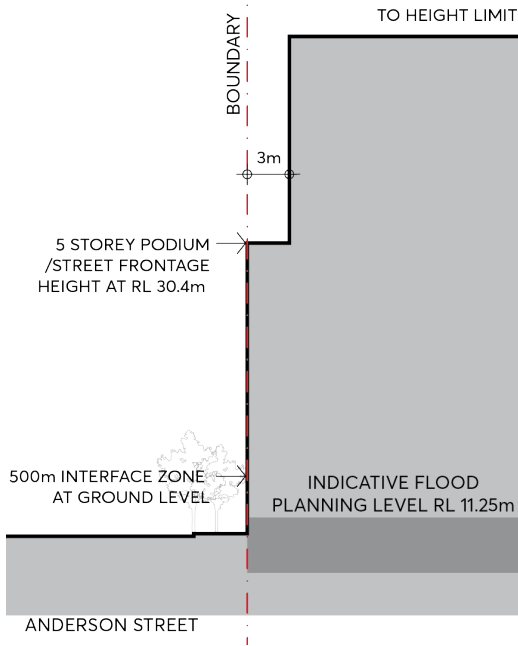

Figure 9.10.16.12 – Anderson Street (East) Street Wall

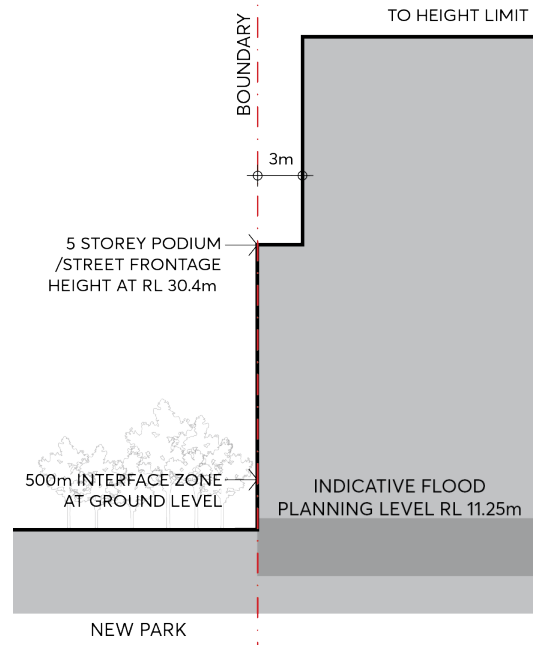

Figure 9.10.16.13 – New Park (South) Street Wall

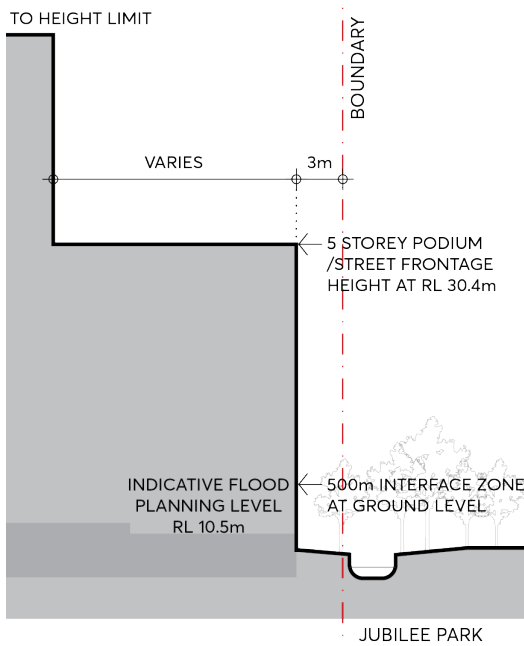

Figure 9.10.16.14 – Jubilee Park (West) Street Wall Indicative Flood Planning Level is 10.74m AHD

- e) Utilise legible architectural elements and spatial types (doors, windows, loggias, reveals, pilasters, sills, plinths, frame and infill, etc.) not necessarily expressed in a literal traditional manner.

- f) Include a ground floor facade design which intensifies the walking experience with particular richness in detail.
- C.27 Under crofts or other interruptions of the street wall which expose the underside of the tower and amplify its presence on the street are not permitted.
- C.28 The active ground floor frontage must be considered in detail, and the following must be incorporated in its design:
- a) A nominal 500mm interface zone at the frontage must be set aside to create interest and variety in the streetscape. This zone is for design elements such as setbacks for entries, opening of windows, seating ledges, benches and general articulation.
 - b) The facade must have a high-level of expressed detail and tactile material quality.
 - c) The articulation of the facade must include a well resolved meeting with the ground that also takes account of any slope. A horizontal plinth, integrated in the design, must be incorporated at the base of glazing to the footpath.
 - d) Building entries should be clearly legible.
 - e) Fire escapes and service doors must be seamlessly incorporated into the facade with quality materials.
 - f) All required services must be incorporated in the design of the ground floor frontage at DA stage.

9.10.17 89-91 GEORGE STREET

This Section applies to 89 to 91 George Street, Parramatta comprising two parcels of land fronting George Street, legally known as Lot 1 DP 505486 and Strata Plan 71180, as shown in Figure 9.10.17.



Figure 9.10.17 – Land application map

This Section is to be read in conjunction with other sections of this DCP and the relevant provisions in *Parramatta LEP 2023*. If there is any inconsistency between this Section and other Sections of the DCP, this Section prevails.

9.10.17.1 DESIRED FUTURE CHARACTER

The redevelopment of the site delivers an A-grade commercial building. The design achieves an elegant tower that contributes to the revitalisation of George Street and reinforces the character of the Parramatta City Centre as a centre for employment, and business. The office tower in the heart of Parramatta's City Centre will meet the needs of office space users to support the Parramatta City Centre in its role as a Sydney's Central Metropolitan Centre.

Redevelopment of the site provides an appropriate relationship to the state significant heritage item known as 'Perth House' to the west of the site whilst responding to the future envisaged scale of the City Centre. The sense of place comes from the significant heritage and culture characteristics of the local context, whilst retail services and public space amenity are critical to the success of the site and surrounding precinct.

The redevelopment establishes an active street frontage to George Street. The design of the building at ground level embraces and enhances the setting of the heritage item and the special qualities of the adjacent streetscape context including the historic Fig tree and Olive tree. Convenient, vibrant, and high-quality retail spaces and publicly accessible spaces service the community in the building and in surrounding buildings.

Floor plates are designed to respect the heritage objectives and meet the needs of government and corporate tenancy workplace requirements. The workplace environment celebrates natural light, fresh air, indoor and outdoor space, worker flexibility, efficiency, comfort, and views of the greater Parramatta region. The design accommodates opportunities for bicycle parking and end of trip facilities.

9.10.17.2 HERITAGE

The subject site does not comprise a listed heritage item on the *Parramatta LEP 2023* or the State Heritage Register (SHR); however as identified in Figure 9.10.17.2, it is located in the vicinity of a number of state and locally listed heritage items, including:

- Perth House, stables, carriageway (SHR no. 00155) - 85 George Street, Parramatta
- Moreton Bay Fig (heritage tree) (SHR no. 00155) – 85 George Street, Parramatta
- Convict Barracks Wall and Potential Archaeological Site (Item no. I717) – 80-100 Macquarie Street, Parramatta
- Convict Drain (Item no. I647) – George Street
- Arthur Phillip High School (Item no. I1720) at 175 Macquarie Street, Parramatta.
- Olive Tree (unidentified item subject to future investigation due to potential to be original planting) – 85 George Street, Parramatta.

Parramatta LEP 2023 sets out the controls for development within the vicinity of heritage items.

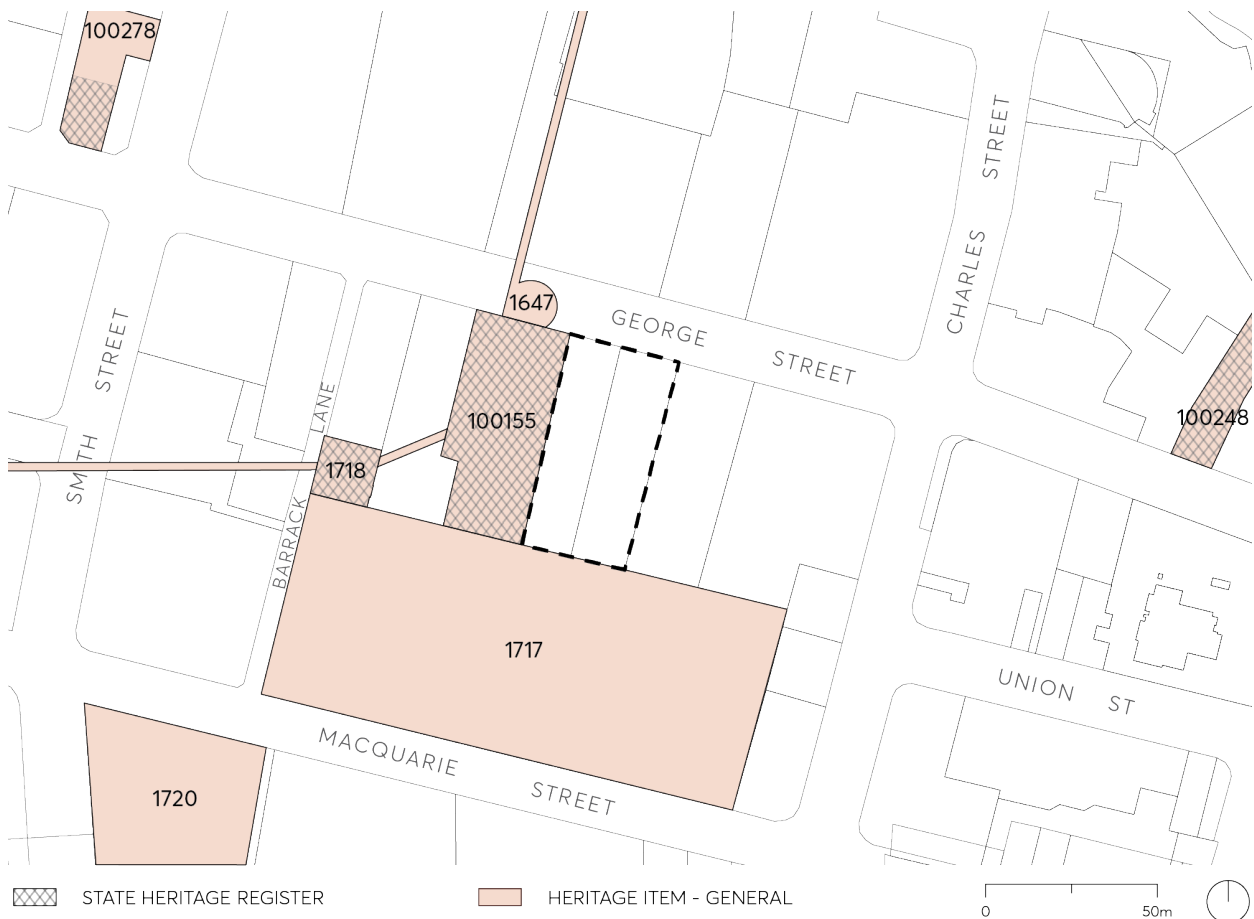

Figure 9.10.17.2 – State and local heritage items in the vicinity of the subject site

Objectives

- O.02 Embrace the distinctive local context by recognising the contextual relationship with the surrounding heritage listed items through a scale and form that is contextually appropriate and for Perth House to be visually prominent when viewed against the podium of new development.
- O.03 Conserve the heritage significance of 85 George and 80-100 Macquarie Street by respecting the heritage buildings and settings.
- O.04 Ensure future development of the site limits its impact on the setting of nearby heritage items and allows Perth House to be visually prominent against the podium of new development.
- O.05 To create a commercial building with setbacks and articulation that are compatible with maintaining a strong streetscape presence for the adjoining heritage item "Perth House".

Controls

- C.01 The development should respond to and protect the significance of Perth House and identified trees, considerate of the heritage interface as shown in Figure 9.10.17.3 in the following ways:
 - a) Podium setbacks to the north (George Street) and west (Perth House – 85 George Street) should comply with the following design principles:

- i views from George Street to the eastern façade of Perth House should be maximised and enhanced by articulation and selection of materials and finishes; and
 - ii setbacks should maintain and enable continued maturity of the Olive Tree associated with Perth House.
- b) The tower form should have a minimum 3 metre separation from the property boundary adjoining Perth House.
 - c) The western façade of the podium is to be designed to respect the scale and maintain legibility of the eastern façade of Perth House through articulation and appropriate selection of materials and finishes.
 - d) Subject to design excellence and environmental impact studies, the western façade of development should have vertical walls, with protrusions and recesses minimised to create a subdued and composed podium that allows Perth House to be visually prominent.
 - e) Landscaping should generally be based on historic landscaping layouts and schemes, and should be used to enhance Perth house presentation.
 - f) Ground floor areas of the future building should provide a direct outlook to the Perth House curtilage, with visual clutter adjacent to Perth House minimised.
 - g) New buildings must incorporate interpretation of heritage significance of the place.

Note – Proponents are referred to best-practice guidelines including Design in Context guidelines for infill development in the historic environment, prepared by the NSW Heritage Office (now Heritage Branch, Office of Environment and Heritage) and RAlA (now Australian Institute of Architects).

- C.02 Any proposal that includes the use of any part of the grounds of Perth House adjoining the site is to minimise impacts on heritage significance having regard to the principles of the Conservation Management Plan for Perth House.
- C.03 Provide opportunities for views of Perth House from George Street (east) with the provision of a heritage view corridor along the frontage of the subject site to maintain the appreciation of the state heritage item and significant trees from the George Street.
- C.04 The fig and olive trees listed as being of heritage significance on 85 George Street as well as existing trees that contribute to the setting of Perth House, must be retained and protected.
- C.05 Materials, finishes and colours for the new development must be carefully selected to ensure that they will not be visually intrusive in the setting of Perth House.
- C.06 Signage must be located so that it does not obscure Perth House or adversely affect its setting.

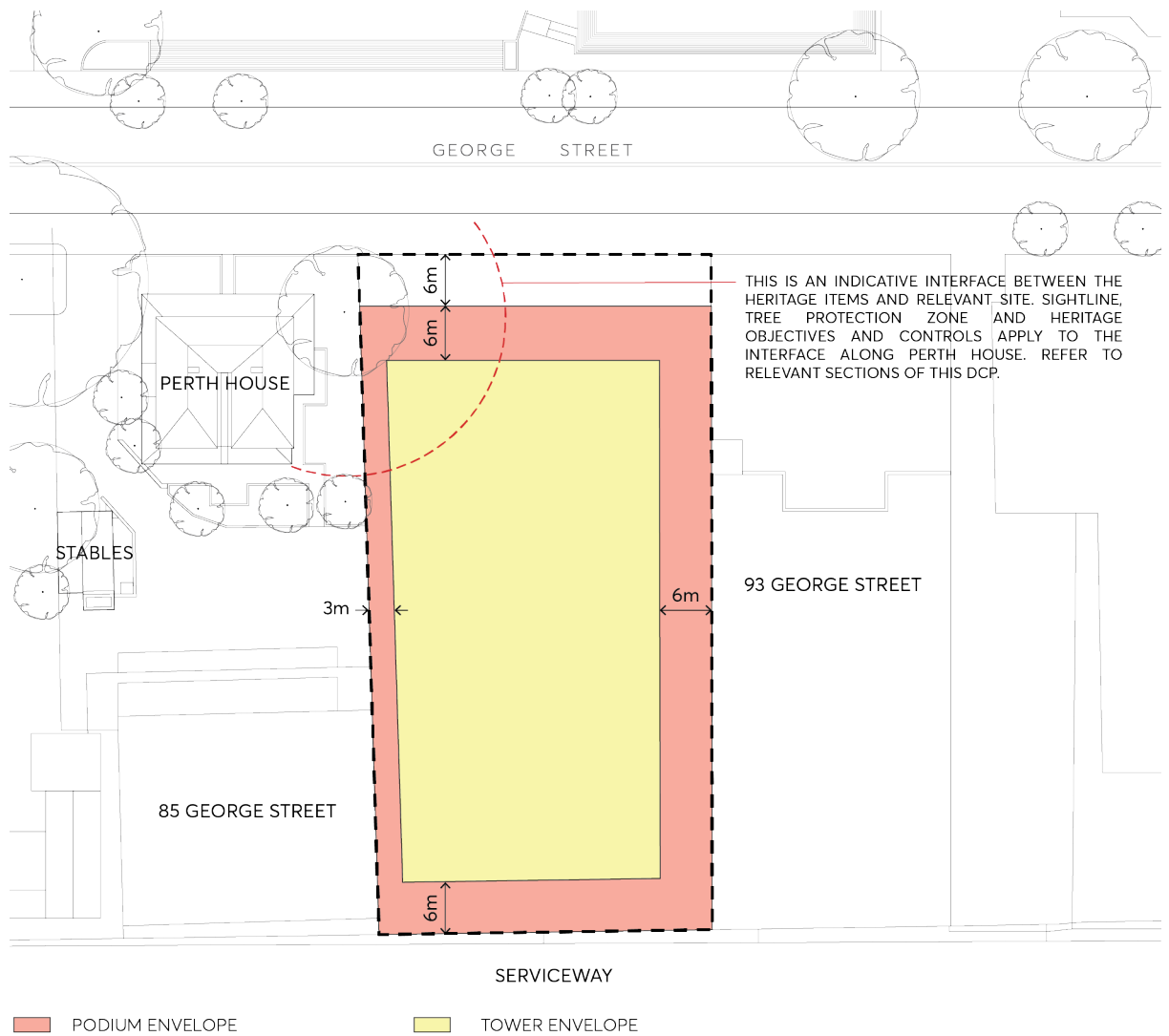

Figure 9.10.17.3 – Heritage Interface (Source: Fender Katsalidis Architects)

9.10.17.3 BUILT FORM

This section seeks to establish built form controls for the site to deliver a development which exhibits architectural design excellence and will positively contribute to the emerging and future character of the Parramatta City Centre. The urban form will enable commercial uses to support a thriving economic City Centre and promoting modern and flexible workplaces.

Objectives

- O.01 Facilitate the redevelopment of the site to achieve a high-quality urban form which respects the heritage significance of adjoining sites and exhibits design excellence.
- O.02 Establish the building envelope requirements for 87-91 George Street, Parramatta and facilitate designers as part of a future design excellence competition.

- O.03 The built form is to provide for flexible and efficient commercial floorplates suitable for achieving A grade office space without compromising the heritage objectives of the DCP controls.
- O.04 Provide for a range of retail uses for the activation of the ground floor plane along George Street suitable for day and night-time activities.
- O.05 Respond to the potential for future road widening and footpath construction within the George Street frontage.

Controls

- C.01 Development should be in accordance with the identified Maximum Building Envelope Diagram as shown in Figures 9.10.17.4 and 9.10.17.5. The following setback requirements are applicable with consideration of the relevant design excellence and heritage objectives:

Podium Setbacks to be observed are:

- Zero Net Carbon in operation.
- 6 metres to the North (front) George Street Podium Setback
- 0 metres West (side) Podium Setback
- 0 metres East (side) Podium Setback
- 0 metres South (rear) Podium Setback
- Podium setbacks at the north-west corner will be subject to additional design controls relating to the interface with the adjacent heritage item and are to address the heritage objectives and controls within the DCP.

Tower Setbacks to be observed are:

- 12 metres to the North (front) George Street Tower Setback
- 3 metres West (side) Tower Setback
- 6 metres East (side) Tower Setback
- 6 metres South (rear) Tower Setback

- C.02 The podium height is to be between 14 metres to 21 metres above the ground level.
- C.03 The podium setbacks to the north (George Street) and west (Perth House – 85 George Street) should comply with the following design principles as shown in 9.10.17.6:
- a) Views from George Street to the eastern façade of Perth House should be maximised and enhanced by articulation and selection of materials and finishes.
 - b) Setbacks should maintain and enable continued maturity of the heritage protected Olive Tree associated with Perth House.
- C.04 The new development is to provide suitable levels of solar access to 85 George Street.
- C.05 Roof design is to make a positive contribution to the quality of the City Centre skyline.
- C.06 Opportunities for outdoor areas and terraces should be considered in order to enhance the amenity for future building occupants.

C.07 Future development should also have regard to the potential wind impact on George Street and publicly accessible areas on the site and adjoining properties.

MAXIMUM BUILDING ENVELOPE DIAGRAM
NORTH-EAST VIEW

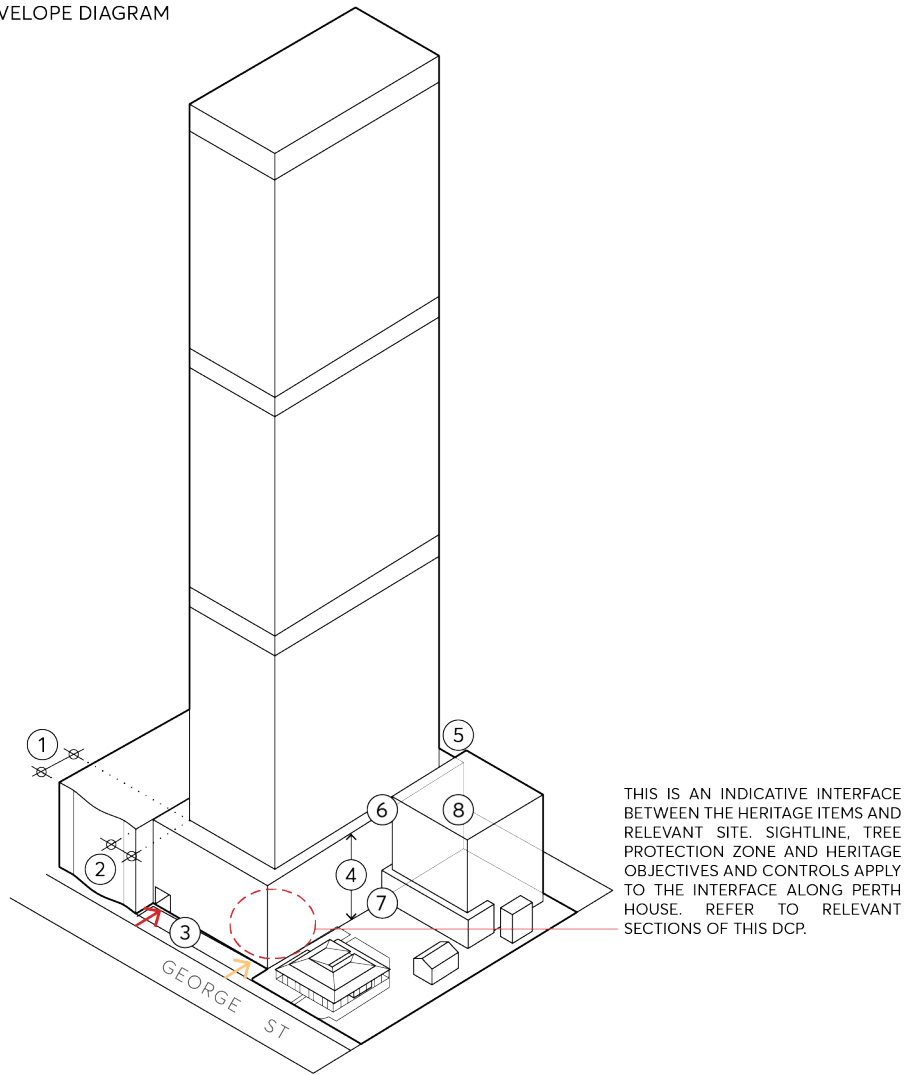

- ① TOWER FRONT SETBACK 12m
- ② TOWER SIDE SETBACK 6m
- ③ PODIUM FRONT ST SETBACK 6m
- ④ PODIUM HEIGHT 14-21m
- ⑤ TOWER REAR SETBACK 6m
- ⑥ TOWER SIDE SETBACK 3m
- VEHICLE ENTRY
- ⑦ PODIUM SIDE SETBACK 0m
- ⑧ PODIUM REAR SETBACK 0m
- PEDESTRIAN ENTRY

Figure 9.10.17.4 – Maximum Building Envelope Diagram, view from North East (Source: Fender Katsalidis Architects)

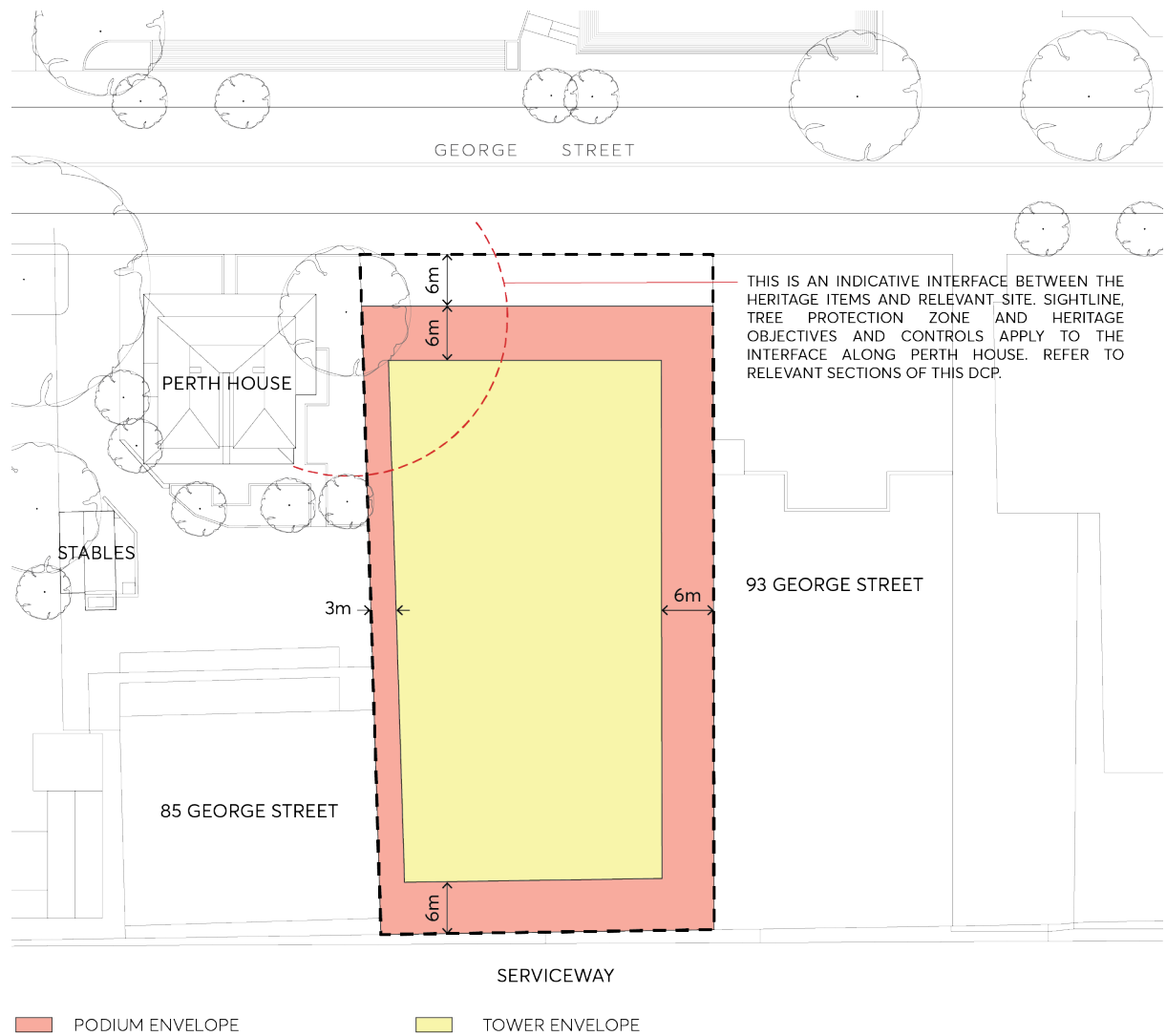

Figure 9.10.17.6 – Building Setback Control Diagram (Source: Fender Katsalidis Architects)

9.10.17.4 SUSTAINABILITY

This section seeks to deliver an ecological sustainable building which responds to the local climate conditions and seeks to combat the effects of the urban heat island affecting Western Sydney. This will implement a best practice sustainability approach based on recognised industry frameworks to deliver the ESD outcomes throughout the design, construction, commissioning, and occupation stages, that respond to the rapidly emerging consciousness of ESD principles both globally and locally.

Objectives

- O.01 Deliver a commercial development that exhibits sustainable design practices and is a legacy for future generations.
- O.02 The development should be resilient to the impacts of climate change and urban microclimate, including extreme heat, storm events, energy uncertainty, water scarcity and bushfires.

- O.03 The design should seek to maximise the quality of the indoor environment and wellness for building occupants and visitors.
- O.04 Building envelopes and façade articulation that are expressive and achieve high levels of solar protection and minimise reflected heat into public areas.
- O.05 Evolve building design to best position the future asset to accommodate a pandemic environment

Controls

- C.01 Development is to achieve the following best practice sustainability standards for the site, including:
- Zero Net Carbon in operation.
 - 6 Star Green Star (Design and As Built) for commercial office buildings under Green Building Council of Australia (GBCA).
 - 5.5 Star NABERS Energy Base Building Rating.
 - 4 Star NABERS Water Base Building Rating.
 - Resilience and flexibility of energy supply.
 - Maximise natural ventilation, daylight and winter sun access.
- C.02 The façade should be designed to minimise energy use by reducing heat gain while improving user comfort through glare control.
- C.03 Design with a circular economy approach to minimise consumption of finite resources both during construction and for the lifecycle of the building. Such as:
- Minimising construction waste to landfill
 - Selecting recycled materials or with low embodied carbon
 - Dematerialising or reducing materials which do not add performance or functional value
 - Introducing design initiatives to reduce operational waste.
 - Designing energy and water efficient systems
- C.04 Explore carbon positive pathways by relying on passive design strategies and exploring high efficiency solutions for building services, maximising the site's potential to integrate renewable energy systems and designing for a fully electrical building (not reliant on gas) and require tenants to deliver fitouts which do not utilise gas.
- C.05 Implement socially sustainable and community engagement practices, following best practice guidelines of early and continued engagement.

9.10.18 8-14 GREAT WESTERN HIGHWAY

This Section applies to land at 8-14 Great Western Highway, Parramatta and described as known as Lot 10 DP 1097949 and SP 8700, as illustrated in Figure 9.10.18.



Figure 9.10.18 – Land application map

This Section must be read in conjunction with other sections of this DCP and the relevant provisions in *Parramatta LEP 2023*. If there is any inconsistency between this section and other sections of the DCP, this section prevails.

This Section establishes objectives and controls to be applied to the preparation and assessment of a development application for the site. It establishes development controls for the built form and urban design objectives for the subject site including building form and massing, setbacks, building separation, heritage interface, landscaping, and potential road widening and vehicular access requirements.

It should be noted that re-development of the site will be subject to a design excellence competition process under Part 7, Division 3 Design excellence in *Parramatta LEP 2023*. The scope of this brief will be informed by the urban design outcomes and principles of this Section.

9.10.18.1 DESIRED FUTURE CHARACTER

The site is redeveloped into a high-quality, water and energy efficient, mixed-use development with residential and commercial uses, including ground floor retail uses which activates the site's frontage to the Great Western Highway. Future development aligns with the vision for the Parramatta City Centre which realises Parramatta as an urban and high-density and high-amenity City Centre.

This Section provides controls on the built form outcomes, vehicular access arrangements, heritage and landscape requirements. This Section recognises the site's location along the Great Western Highway as a major arterial road and seeks to ensure safe ingress and egress and maintain the efficient functioning of traffic along this road corridor.

Site Objectives

- O.01 To facilitate the development of a mixed use building on the site which provides an activated street frontage, commercial floor space within a building podium, and a residential tower above.
- O.02 Ensure that built form achieves contextual fit with adjacent buildings, both existing and future.
- O.03 Protect and manage the impact of development on the public domain and neighbouring sites.
- O.04 To ensure the nominated setback to the Great Western Highway can accommodate the potential for future road widening.
- O.05 Provide vehicular access points and circulation that is safe and minimises impact to the operation of the intersection between Great Western Highway and Church Street.
- O.06 Ensure that the building design is sympathetic to nearby heritage items and does not detract from their value.
- O.07 Ensure that nearby heritage items are protected during the redevelopment of the subject site.
- O.08 Require that any potential archaeology is managed in accordance with the requirements of Heritage NSW.
- O.09 Provide deep-soil zones across the site to allow for adequate landscaping and allow for large tree plantings at the front and rear of the development.
- O.10 Ensure that built form enables a healthy environment for street trees within the front setback.

9.10.18.2 BUILT FORM AND MASSING

Principles

- P.01 To define built form and massing principles that achieve good urban design outcomes for the site context.

Set back buildings above the street wall and side and rear boundaries to allow daylight penetration, mitigate wind impacts and enable views to the sky in streets and public places.

Design street walls to create streets that are legible, comfortable, safe, functional and attractive.

Design towers to be elegantly proportioned and maximise its slenderness of form.

Design Controls

Maximum Building Height

C.01 The building will present a commercial podium of 4 to 5 storeys to Great Western Highway with residential tower setback above.

Building alignment and setbacks

- C.02 The building is to be aligned parallel with the Great Western Highway.
- C.03 Street setbacks and street wall heights are to comply with Figure 9.10.18.2 and Figure 9.10.18.3, whereby development is to have a 6 metre setback at ground, and a 3 metre upper level setback for tower above.
- C.04 The building (podium) setback is to have a 6 metre setback to the existing boundary with the Great Western Highway, 3 metre from the eastern boundary, 6 metre to the northern boundary and a 3 metre setback to the western boundary.
- C.05 The basement is to be located wholly within the build footprint, with the exception of the western boundary and a portion of the northern boundary as shown in Figure 9.10.18.2. A nil setback is permitted at these locations for basement levels that generally marry with the ground floor level of the development on 18 – 20 Great Western Highway.
- C.06 The 6 metre front setback is to be measured from the existing boundary in accordance with Figure 9.10.18.3. The front setback is to ensure adequate deep-soil planting, and where possible, the retention of existing trees. In the event of any future widening of Great Western Highway is required, the setting of the building is not required to change.
- C.07 The residential tower above commercial podium is to be setback 9 metre from all existing site boundaries.

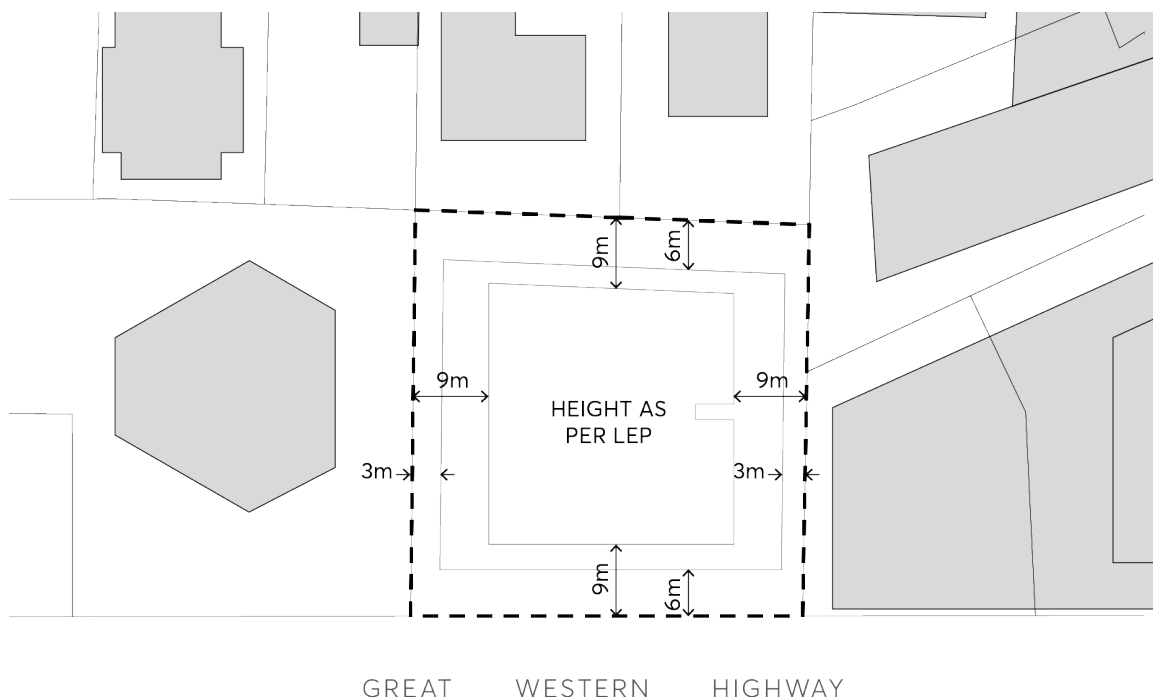

Figure 9.10.18.2 – Building alignment and setbacks

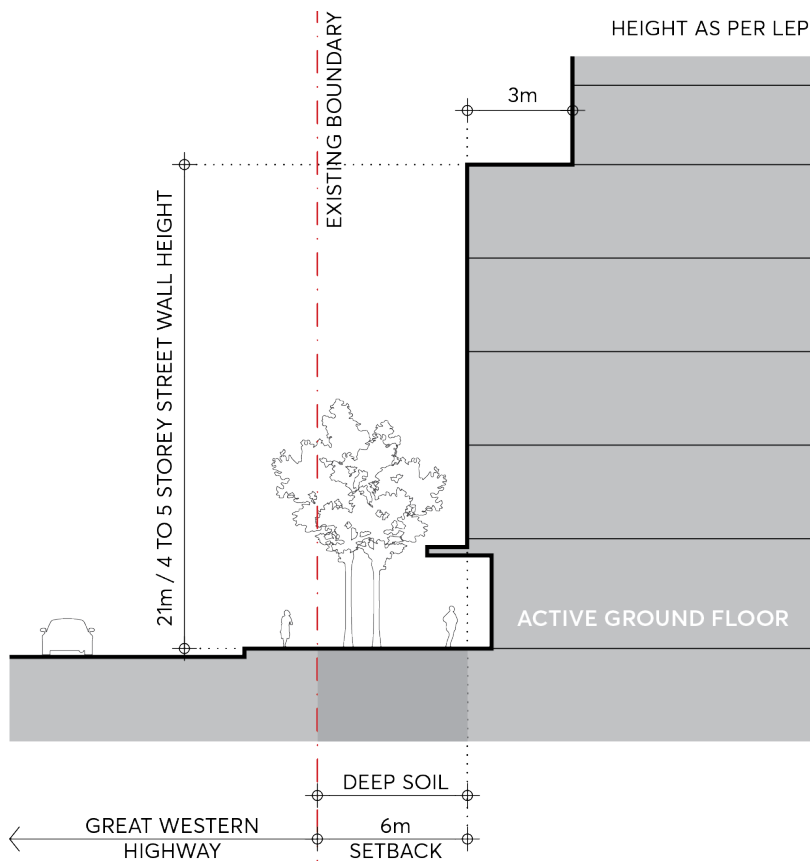

Figure 9.10.18.3 – Street Setbacks to Great Western Highway

C.08 Future development must provide for a minimum building separation above street wall height of 18 metres, where separation distances must be apportioned equally between adjacent sites.

9.10.18.3 STREET WALL DESIGN AND GROUND FLOOR

C.01 The street walls must:

- Be modulated vertically in increments that relates to a fine grain subdivision and negotiates any stepping in the ground floor level.
- Be of predominantly masonry character with no lightweight panel construction or curtain walling.
- Be articulated with depth, relief, and shadow on the street façade. A minimum relief of 150mm between the masonry finish and glazing face must be achieved.
- Utilise legible architectural elements and types - doors, windows, loggias, reveals, pilasters, sills, plinths, frame and infill, etc. - not necessarily expressed in a literal traditional manner.
- Include semi-recessed awnings for pedestrian shelter, in accordance with Figure 9.10.18.5.

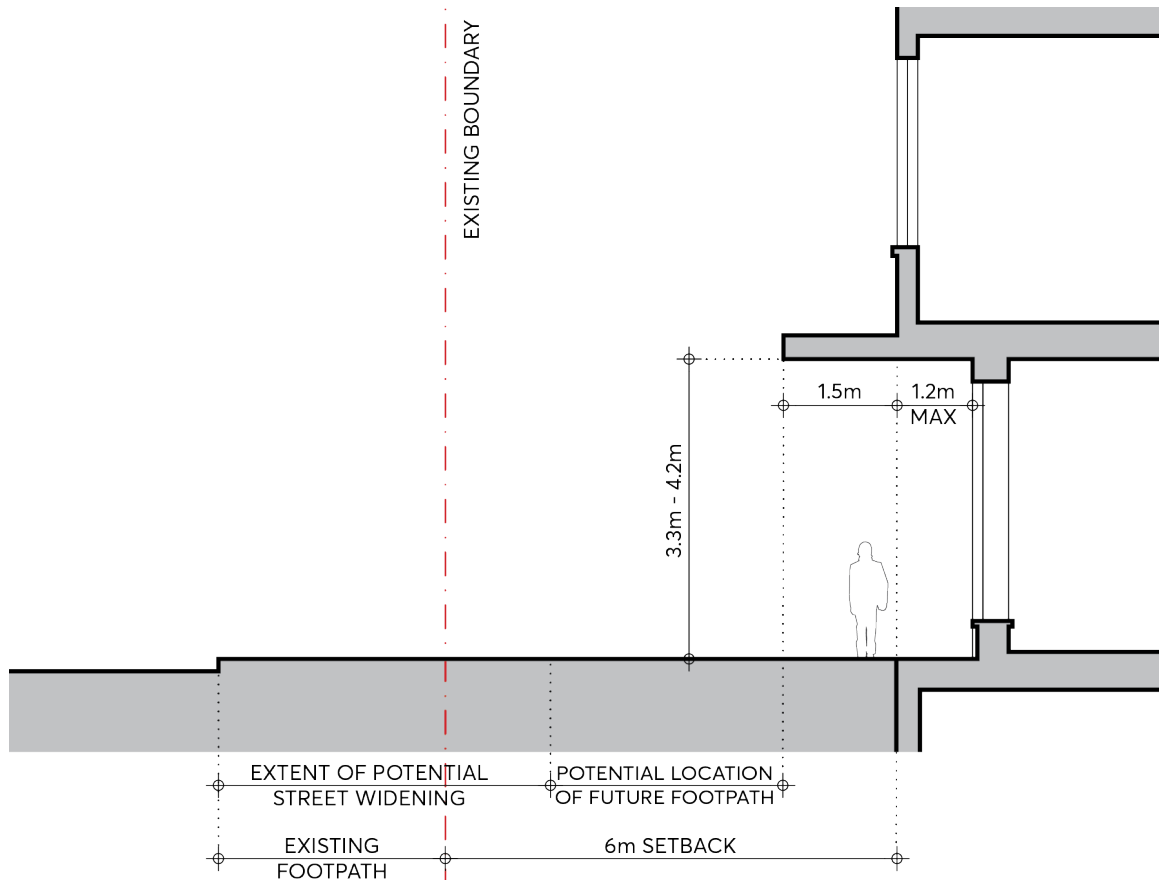

Figure 9.10.18.4 – Ground Floor Interface Zone

C.02 The active ground floor frontage must be considered in detail and the following must be incorporated in its design, as per Figure 9.10.18.4:

- a) Active uses must fully occupy the ground floor frontage and not taken up by services.
- b) A nominal 500mm interface zone at the frontage must be set aside to create interest and variety in the streetscape, to be used for setbacks for entries, opening of windows, seating ledges, benches, and general articulation.
- c) The façade must have a high level of expressed detail and tactile material quality.
- d) The articulation of the façade must include a well resolved meeting with the ground that also takes account of any slope. A horizontal plinth, integrated in the design, must be incorporated at the base of glazing to the natural ground level or footpath.
- e) Design solutions need to maintain and reflect the levels of the existing footpath, incorporating a fine grain response that allows the ground floor tenancies to step with the sloping public domain.

9.10.18.4 ACCESS, PARKING AND SERVICING

Access control

- C.01 Vehicular ingress and egress into the site must be provided near the site’s western boundary so that the access point does not impact on the operation of the Great Western Highway and Church Street intersection (Figure 9.10.18.5 and Figure 9.10.18.6).
- C.02 The driveway from the Great Western Highway must be a minimum of 12m wide and comply with Council’s engineering standards.
- C.03 All vehicles, including service vehicles, must enter and exit the site in a forward direction.
- C.04 All areas for car parking, loading, deliveries and servicing shall be located within the boundaries of the site. A swept path analysis must demonstrate that the largest vehicle likely to access the site can safely and efficiently manoeuvre in these areas.

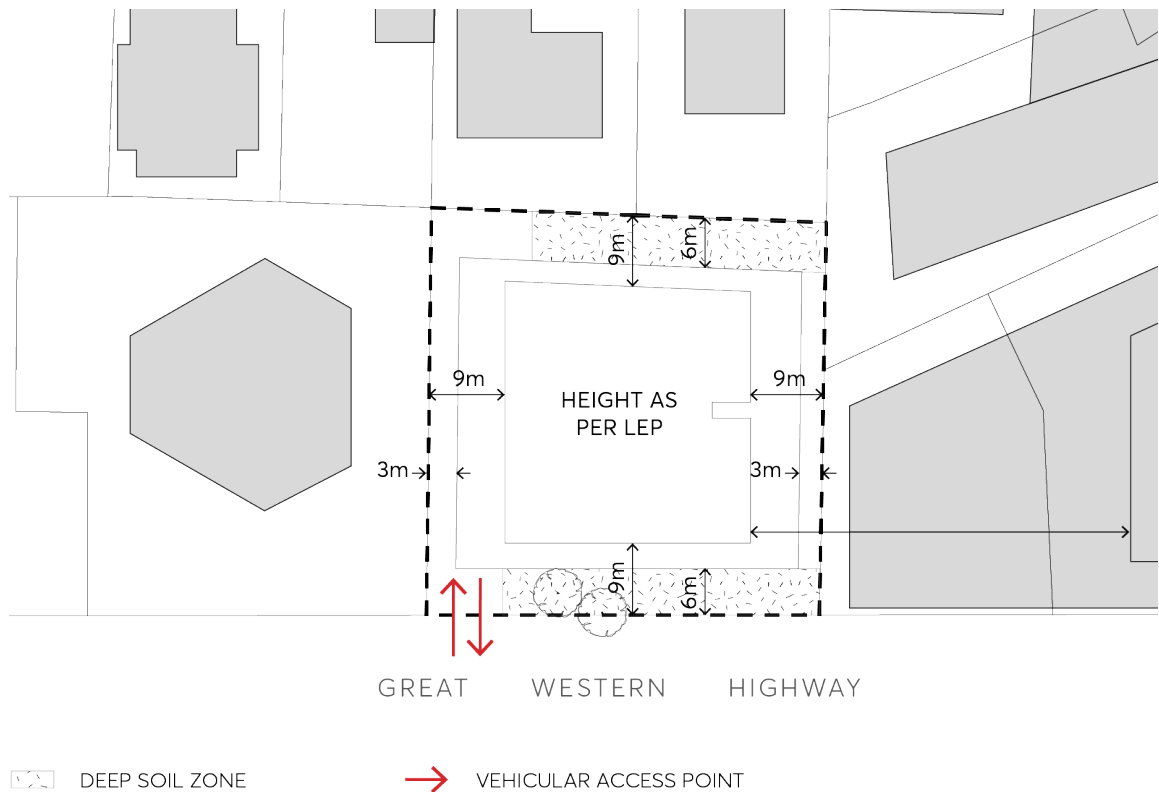

Figure 9.10.18.5 – Location of proposed vehicular access along the western site boundary and landscaping impact

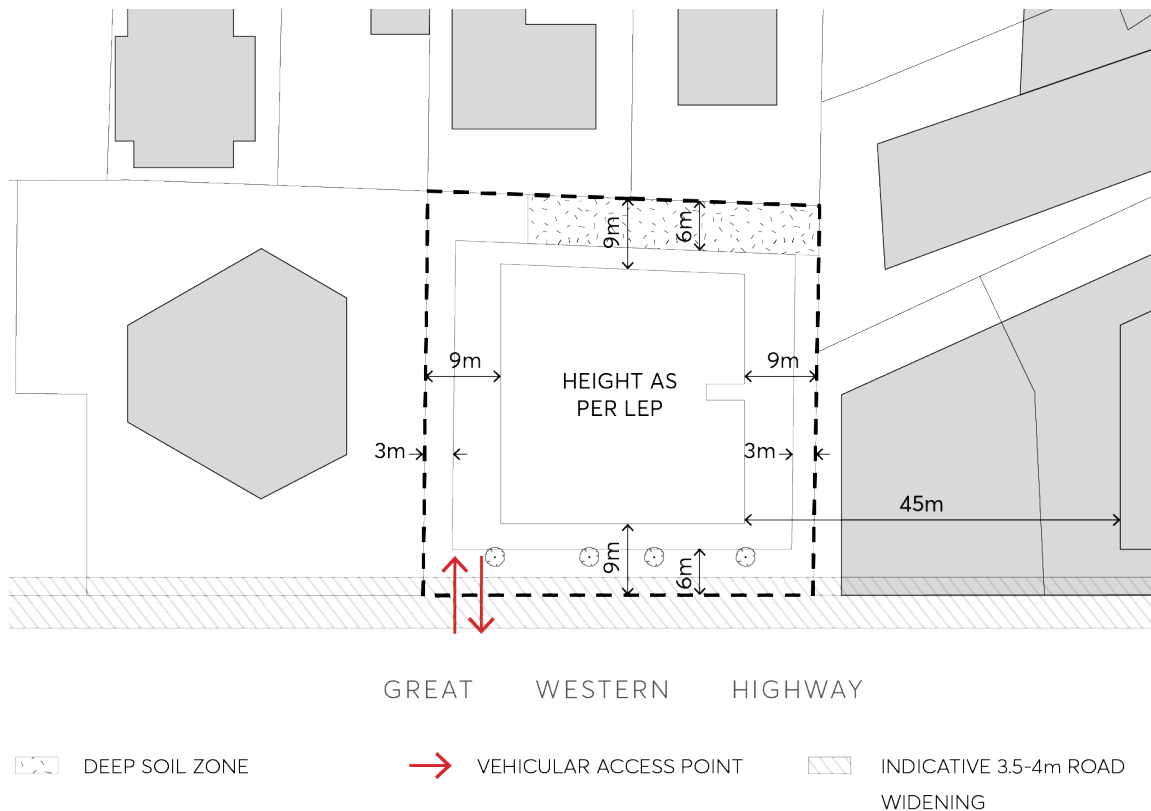

Figure 9.10.18.6 – Indicative extent of road widening on Great Western Highway and landscaping impact

9.10.18.5 HERITAGE

The area subject to the proposal is located in vicinity of two State heritage listed items: Lennox House at 39 Campbell Street and Parramatta Masonic Centre at 47 Campbell Street. Part of the subject area (specifically No 8 Great Western Highway) is identified as being of local significance, and having moderate archaeological research potential.

Heritage controls

- C.01 Any development on the site must be accompanied by a geotechnical report and a structural engineer’s report, to assess impact of works on the suitability of grounds, and structural stability of the two adjacent heritage items during and after construction.
- C.02 During any construction works, protection of significant fabric of the adjacent heritage items must be ensured and any damaged or weakened fabric repaired or reconstructed to Council’s satisfaction.
- C.03 An assessment of heritage impact, including models and photomontages, must be prepared and submitted with any development application, to ensure the buildings form, proportions, view lines, materials, colours and design respond to the heritage items.
- C.04 Archaeological requirements must be confirmed with Heritage NSW, and evidence of their support provided to Council before determination of any Development Application.

9.10.18.6 LANDSCAPING

Landscaping controls

- C.01 Deep-soil planting should be maximised at the front and rear setbacks the site, including tree planting.
- C.02 Screen planting, tree pits and planter boxes may be provided along the side boundaries, but only in instances where it is not possible to provide deep-soil planting.
- C.03 Existing trees located along the Great Western Highway within the site boundary are to be retained unless it is demonstrated that they are impacted the potential road widening or access driveways along this frontage.

9.10.19 8-12 VICTORIA ROAD AND 2A VILLIERS STREET

This Section applies to land at 8 – 12 Victoria Road and 2A Villiers Street, Parramatta, as shown in Figure 9.10.19.



Figure 9.10.19 – Land Application map

9.10.19.1 DESIRED FUTURE CHARACTER

The site at 8–12 Victoria Road and 2A Villiers Street, Parramatta is on the northern edge of the Parramatta City Centre, which is transitioning from low scale in the north west to high density mixed use development in the east and south. The context of the site includes a number of important heritage items – Prince Alfred Park to the south, Our Lady of Mercy College to the west and St Patrick’s Cathedral diagonally opposite to the south west. The proximity of the site to the Parramatta River and City Centre core supports an intensity of development while respecting the important heritage setting.

Future built form will be designed to achieve a harmonious relationship with neighbouring heritage buildings as well as to provide appropriate heights and setbacks to street frontages. Low building forms will occupy land fronting Victoria Road and a slim tower will be located in the north western corner of the site. As a result, the visual scale of development will be reduced on Victoria Road, providing a suitable frame and backdrop for Prince Alfred Park and minimising overshadowing of

this park. Building articulation and modulation of the Victoria Road facade will ensure that the building suitably addresses the road and Prince Alfred Park.

Active uses will be located on the ground floor of buildings fronting Victoria Road and Villiers Street to increase the vibrancy of the site and locality.

The property boundary on Villiers Street will incorporate a setback to allow under width road lanes in Villiers Street to be widened. A setback will be provided on the eastern boundary to allow the formation of a through site link between Victoria Road and Ross Street.

Development must comply with the objectives and controls set out below and any other relevant objectives and controls of this DCP.

Site Objectives

This Section documents the objectives that will determine the future form of development of the subject site. The objectives establish the key parameters that will ensure that future development on the site contributes to achieving the overall desired future character.

- O.01 To provide for development that supports the growth of a vibrant precinct on the northern edge of the Parramatta City Centre.
- O.02 To encourage high-quality built form outcomes and achieve design excellence.
- O.03 To minimise any adverse impacts on the amenity of adjoining heritage uses and in particular Prince Alfred Park.
- O.04 To improve pedestrian connectivity between Victoria Road and Ross Street.
- O.05 To provide for the establishment of non-residential uses on the Victoria Road and Villiers Street ground floor frontages of the site.
- O.06 To provide for improved traffic flows on Villiers Street.

9.10.19.2 BUILDING FORM AND MASSING

Objectives

- O.01 To respond sensitively to the scale, proportions and form of the nearby heritage items at Prince Alfred Park, St Patrick's Cathedral and Our Lady of Mercy College.
- O.02 To limit overshadowing impacts on Prince Alfred Park.
- O.03 To ensure that the Victoria Road facade is of a civic scale with strong vertical articulation and fine grain.
- O.04 To ensure that the Victoria Road frontage provides good pedestrian amenity by incorporating elements such as an open colonnade or continuous footpath awnings.
- O.05 To ensure that the built form at the Villiers Street corner complements the form and materials of St Patrick's Cathedral.

Controls

Maximum building heights

- C.01 The distribution of building height across the site is to be in accordance with Figure 9.10.19.1, 9.10.19.2, 9.10.19.3.

Street frontage heights

- C.02 Maximum street wall height of 14m facing Victoria Road and Villiers Street with a setback of 4m to the upper levels as shown in Figure 9.10.19.1, 9.10.19.2, 9.10.19.3.

Building setbacks

- C.03 Minimum 3m on the eastern boundary to allow for the establishment of a through site link between Victoria Road and Ross Street, as shown in Figure 9.10.19.1.

Building design

- C.04 Buildings are to be designed with regard to nearby heritage items and to ensure sensitive consideration of colour, materials, and building articulation.

9.10.19.3 TRAFFIC AND TRANSPORT

Site Objectives

- O.01 To minimise pedestrian and vehicle conflict by limiting vehicle crossings in the public domain.
- O.02 To provide space to widen Villiers Street to accommodate increased traffic and pedestrian volumes as a result of additional development on the site.

Controls

- C.01 All vehicular access must only be provided along Villiers Street and be located as far as possible from Victoria Road.
- C.02 A minimum 1m boundary setback is to be provided on Villiers Street, as shown in Figure 9.10.19.1.



Figure 9.10.19.1 – Built Form Design Controls – Heights and Setbacks

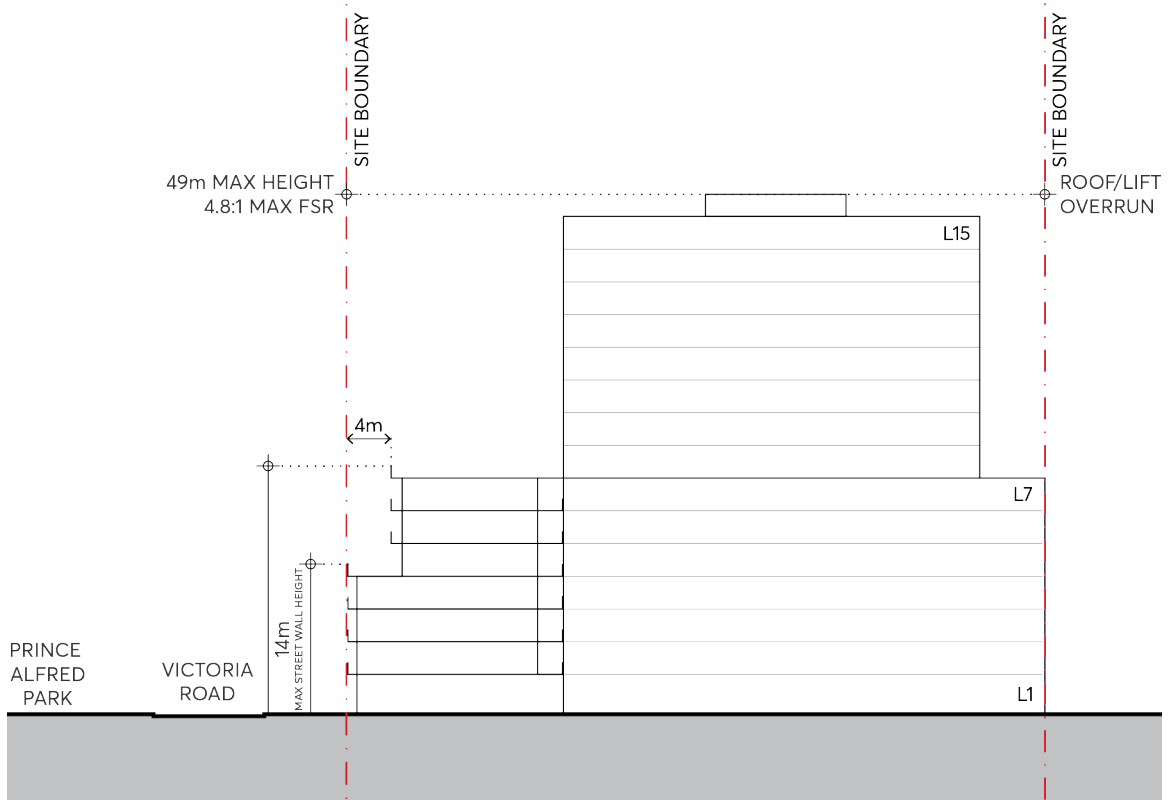

Figure 9.10.19.2 – North - South Section of Site Building Envelope

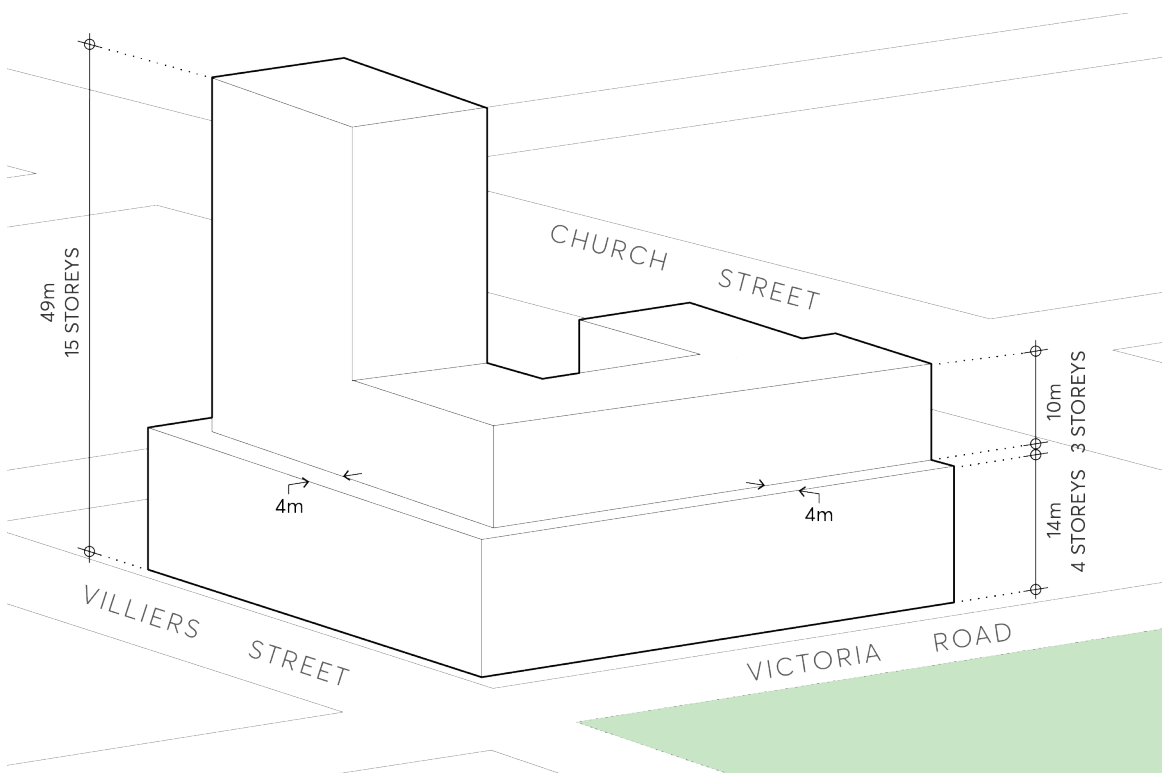

Figure 9.10.19.3 – Indicative Built Form

9.10.20 470 CHURCH STREET, PARRAMATTA

This Section applies to land at 470 Church Street, Parramatta legally known as Lot 1 DP 785930 within the Parramatta City Centre – Deferred Area A as illustrated in Figure 9.10.20 below.



 SUBJECT SITE

Figure 9.10.20 – Land application map

This Section establishes site specific principles, objectives and controls to be interpreted during preparation and assessment of Development Applications for the site and is to be read in conjunction with Part 9 including Section 9.5.11 – Church Street North Special Area.

9.10.20.1 DESIRED FUTURE CHARACTER

Future mixed use development proposed at the site is consistent with the State Government policies to facilitate a renewed Parramatta City Centre. The site is located adjacent the Parramatta Light Rail route, that connects the Westmead Precinct (to the west of the site) and the centre of the Parramatta City Centre (to the south of the site).

The mixed use character of development complements the Parramatta City Centre and provides a positive design outcome. The proposed mix of land uses includes retail/commercial uses on the ground floor and level 1 and residential apartments above.

Design Principles

The following design principles are to be incorporated into the future design of the building:

- P.01 Respond to the north facing frontage and generally east-west site with an appropriate built form that maximises solar access.
- P.02 Create a podium and presentation to the street of design excellence which contributes to the design quality of space and streets in the City Centre.
- P.03 Comprise a podium edge to the streets with recessed tower form. The podium is to be four storeys.
- P.04 The street wall should be designed to provide a well-modulated pedestrian experience at street level. A smaller, more detailed scale should be used in its articulation.
- P.05 Ground floor façade should be rich in variation and detail. Vertical relief in the façade maximises the walking experience, with awnings included and integrated in the design so as to provide adequate pedestrian shelter.
- P.06 Development is to comply with the objectives and controls set out below and any other relevant objectives and controls of this Section.

Site objectives

- O.01 To provide a mix of uses that support the role of Parramatta City Centre.
- O.02 To revitalise Church Street and Harold Street.
- O.03 To encourage high-quality built form outcomes and achieve design excellence.
- O.04 To minimise adverse impacts on the amenity of adjoining uses.

9.10.20.2 BUILT FORM, DESIGN AND MASSING

Objectives

To ensure that the built form:

- O.01 Responds positively to the site's location in relation to the City Centre, nearby Sorrell Street Heritage Conservation Area and the streetscape.
- O.02 Has a positive and cohesive relationship with surrounding land and uses.
- O.03 Has adequate separation to minimise visual bulk and to ensure adequate amenity within the site and to neighbouring development.
- O.04 Achieves usable and pleasant street and podium environment in terms of daylight and solar access, scale and wind mitigation.

Controls

Street Frontage Heights

C.01 The street wall is to be built to a height of 14m (3-4 storeys) fronting Church and Harold Streets.

Building Setbacks

C.02 The minimum building setbacks are to be in accordance with the table below:

Minimum setback (m)	
Podium	
Western boundary (Church Street)	0m
Northern boundary (Harold Street)	3m
Eastern boundary	4.5m
Southern boundary	0m (commercial) 6m (residential levels 2-3)
Tower (upper level)	
Western boundary (Church Street)	6m
Eastern boundary	12m
Northern boundary (Harold Street)	6m (to the property boundary, 3m to the podium)
Southern boundary	6m (to the property boundary)

Tower Floor Plate

C.03 The reduced tower setback of 6m to the southern boundary will accommodate a tower with a floorplate of approximately 650m².

Building Design

C.04 The street wall/podium is to be a separate architectural element, that is distinct and different in character from the tower element.

C.05 High-quality design and materials are to be used for the security shutters into the car park and loading areas.

C.06 To ensure landscape courtyard on the podium is usable, take into account solar access and wind mitigation.

9.10.20.3 LAND USES

Objectives

O.01 To provide for useable and functional commercial floor space that can support the desired use, achieve internal spaces appropriate to their function and support the Parramatta City Centre.

Controls

O.01 The ground floor street frontage is to be used for active commercial uses.

O.02 Commercial/retail tenancies are to be of a sufficient size and layout to cater for their desired use and function.

9.10.20.4 TRAFFIC AND TRANSPORT

Objectives

- O.01 To ensure adequate parking is provided on site.
- O.02 To minimise pedestrian and vehicle conflict by locating vehicle access away from the Church Street intersection.
- O.03 To ensure parking design is integrated into the design of the building.

Controls

- C.01 Vehicle access is to be from Harold Street, at the eastern end of the site.
- C.02 Parking in the podium is discouraged. However, where it is provided it must be well integrated into the overall facade and not be visible from the public domain utilising screening or other appropriate design excellence solution.
- C.03 Car parking is to be provided in accordance with clause 7.18 in *Parramatta LEP 2023* and bicycle parking is to be provided in accordance with Section 9.9.3 – Bicycle Parking and End of Journey Facilities.

9.10.21 65-79 MACQUARIE STREET, 38 HUNTER STREET, 195 CHURCH STREET AND 45 HUNTER STREET, PARRAMATTA (ST JOHN'S ANGLICAN CATHEDRAL)

This Section applies to 65-79 Macquarie Street (Lot E-K, DP15108), 38 Hunter Street (Lot M, DP15108), 195 Church Street (Lot 1-2, DP1110057) and 45 Hunter Street (Lot 1-2, DP575473), Parramatta as shown in Figure 9.10.21.1.



Figure 9.10.21.1 – Land application map

This Section must be read in conjunction with other Sections of Parramatta DCP 2023 and *Parramatta LEP 2023*. If there is any inconsistency between this Section and other Sections of this DCP, this Section prevails.

This Section establishes objectives and controls to be interpreted during the preparation and assessment of Design Competitions and Development Applications (DAs) and supports the objectives of the relevant provisions in *Parramatta LEP 2023*.

Options for Development and Planning Pathway

The structure of Section 9.10.21 reflects the two re-development options for the subject site. The options include:

Option A – for the redevelopment of the St John’s Church site for a new commercial building, new residential building and associated public domain works including expansion of the open space area to incorporate part of Hunter Street located on the western side of the Cathedral and removal of the St Johns Parish Hall building and replacement with new Parish facilities in the podium of the new commercial building and hereafter referred to as “Option A - St Johns Parish Hall removed and replaced”.

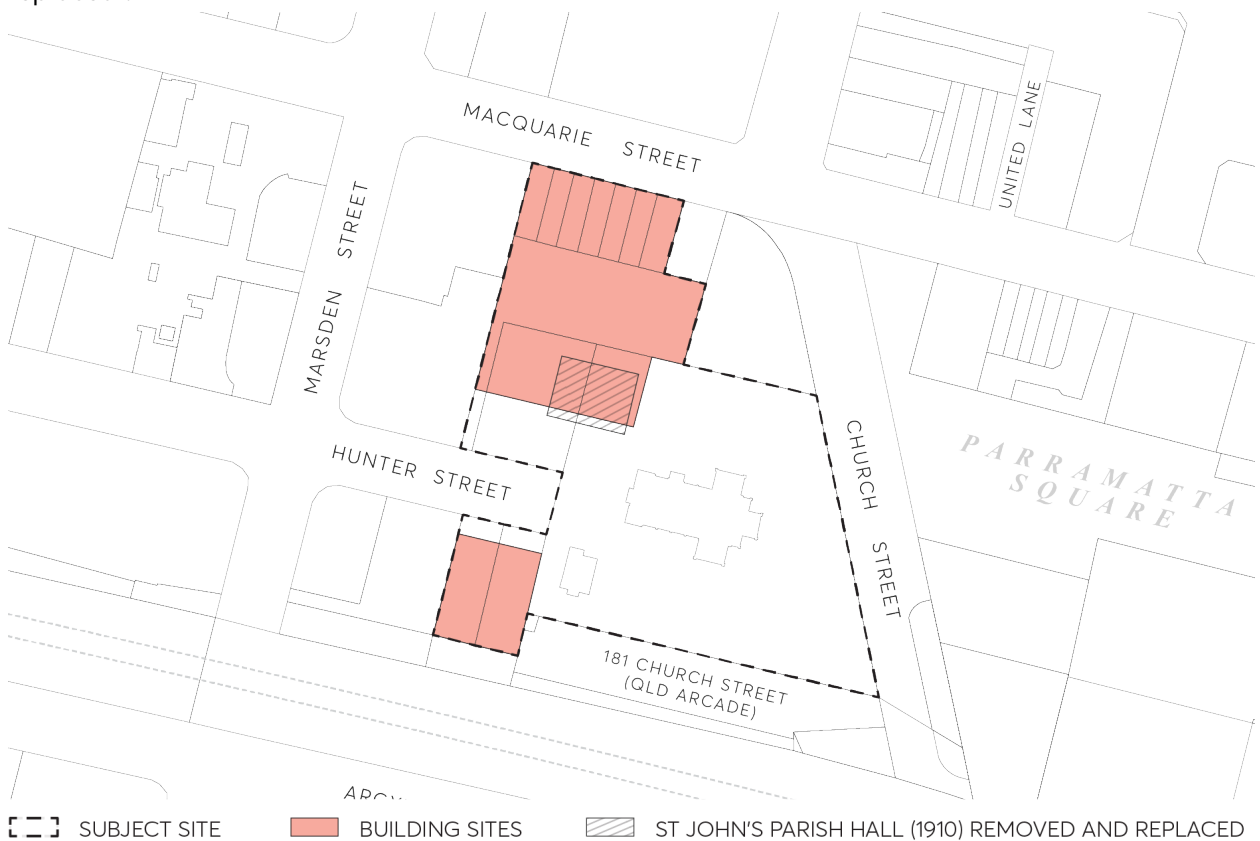

Figure 9.10.21.2 – St John’s Parish Hall under Option A

Option B – for the redevelopment of the St John’s Church site for a new commercial building, new residential building and associated public domain works that includes the retention of the original part of the St Johns Parish Hall building and hereafter referred to as “Option B - St Johns Parish Hall partially retained”.



Figure 9.10.21.3 – St John's Parish Hall under Option B

Council's Design Excellence Process requires a successful Architectural Design Competition Process to be undertaken before a Development Application can be lodged with Council. To enable a Design Competition process to deliver Design Excellence, the preferred planning pathway is a staged Development Application process comprising of the following three key steps:

STEP 1: Stage 1 Development Application for the proponent's building envelopes, proposed removal and replacement or partial retention of the St John's Parish Church Hall, public domain design and vehicle access and basement design. Supporting the assessment, the following documents must be submitted:

- i) Updated Reference Design
- ii) Conservation Management Plan
- iii) Structural Report (assessing impacts of underground car parking on heritage items).
- iv) Acoustic Report (assessing noise and vibration impacts from underground car parking on heritage items).
- v) Interpretation Strategy (finalised Interpretation Plan will be lodged at Stage 2).
- vi) Concept Landscape Plan.
- vii) Arborist Report
- viii) Heritage Impact Statement.
- ix) Archaeological Test Excavation Report

STEP 2: Design Excellence Competition for a single design scenario based on approval of the Stage 1 DA.

STEP 3: Stage 2 Detailed Development Application based on winning Design Competition entry.

Where a Stage 1 Development Application determined that the St Johns Parish Hall should be removed and replaced, the DCP controls for "Option A - St Johns Parish Hall removed and replaced" and "Controls that apply to Option A and Option B " would be used to inform a Design Brief for the Design Competition and to assess a Stage 2 Development Application.

Conversely, where a Stage 1 Development Application determined that St Johns Parish Hall should be partially retained, the DCP controls for "Option B - St Johns Parish Hall partially retained" and "Controls that apply to Option A and Option B " would be used to inform a Design Brief for the Design Competition and to assess a Stage 2 Development Application.

The preferred planning pathway outlined above is considered the most appropriate pathway, providing certainty regarding the proposed form of development to occur on the site. As the primary objective of a Design Excellence Competition is to deliver the highest standard of architectural, urban and landscape design, understanding the heritage significance of the St John's Parish Church Hall prior to undertaking the Design Competition is considered best practice. Further, the above process requiring a Stage 1 Development Application would remove the requirement for competitors to submit two design scenarios for consideration.

Before lodging a Development Application, including a Stage 1 Development Application, early consultation with Council is encouraged to formulate an agreed public domain design brief and public domain design, as well as an Interpretation Strategy.

OPTION A - ST JOHN'S PARISH HALL REMOVED AND REPLACED

9.10.21.2 DESIRED FUTURE CHARACTER

St John's Anglican Cathedral occupies a prominent site in the heart of the City Centre. It is the oldest Church site and continuous place of Christian worship in Australia dating from 1803. Development of the site is congruent with the Cathedral's State heritage significance. This DCP supports the on-going role and heritage significance of St John's Anglican Cathedral, as a landmark site in the City Centre.

Development of the site must enhance the heritage values associated with the St John's Anglican Cathedral, and its immediate surrounds. The site extends the public spaces created by Parramatta Square and Centenary Square, framed by built form around the Cathedral with buildings positioned to maintain solar access to the key public open spaces. St John's Anglican Cathedral is reinforced as the focal point for key views following the alignment of Church Street and Parramatta Square. The design of new open space accommodates the use of the St John's Anglican Cathedral as a place of Anglican worship and provides for general movement and public uses.

Building design achieves elegant, contextually responsive forms that contribute to the significance of the area and reinforce the character of Parramatta as a centre for employment, business and living. New buildings enhance activation of the publicly accessible spaces around St John's Anglican

Cathedral connecting with new Parish facilities of the Church and the Southern development site to comprise of an amalgamation with 41 and 43 Hunter Street in order for any future development to achieve good amenity and appropriate relationships to the heritage context of the Cathedral complex.

An enlarged, publicly accessible open space to the west of St John's Anglican Cathedral (once St John's Parish Hall is removed) is provided.

Site Objectives

- O.01 Provide a setting for St John's Anglican Cathedral and the associated public domain that is sensitive to the heritage significance of the site and its significant elements.
- O.02 Deliver employment uses within the City Centre that contribute to Parramatta's employment objectives.
- O.03 Deliver a civic response through the provision of public access, additional open space and public domain upgrades.
- O.04 Facilitate the continued use of the site for Anglican worship supported by contemporary spaces for the Parish of Parramatta to support their ongoing use of the place.
- O.05 Balance active street frontages and flood mitigation requirements.
- O.06 Enhance the heritage significance of the Warden Cottage (Verger's Cottage), St John's Building and the Bicentennial Square heritage listing, to communicate the historical evolution of the landmark site between St John's Anglican Cathedral and contemporary development.

9.10.21.3 HERITAGE

This Section of this DCP must be read in conjunction with:

- Section 9.6 – Heritage
- Part 7 – Heritage and Archaeology
- Clause 7.22 Managing heritage impacts of Parramatta LEP 2023

Where there is an inconsistency between the heritage controls and objectives in this Section and other Parts of this DCP, this Section prevails.

9.10.21.3.1 HERITAGE LISTINGS

State heritage listing

- The subject site contains a State heritage item known as St John's Anglican Cathedral (SHR ID 01805)

Local heritage listing

- St John's Anglican Cathedral (item no. I465)
- St John's Parish Hall (item no.I466)
- Warden's Cottage (Verger's Cottage) (item no.I467)
- Bicentennial Square and adjoining buildings (item no.I461)
- St John's Building at 38 Hunter Street (included in the Bicentennial Square heritage listing)

The subject site is in the vicinity of several state and locally listed heritage items, including:

- Centenary Square and adjoining buildings (item no.1461).
- Murray's Building (and potential archaeological site) (item no.I464)
- Centennial Memorial Clock (item no.I468)
- Parramatta Town Hall (and potential archaeological site) (item no.I463)
- Shop (and potential archaeological site) (item no.I469)
- Two-storey residence, No. 41 Hunter Street (item no.I573)

The *Parramatta LEP 2023* sets out the controls for development within the vicinity of heritage items.

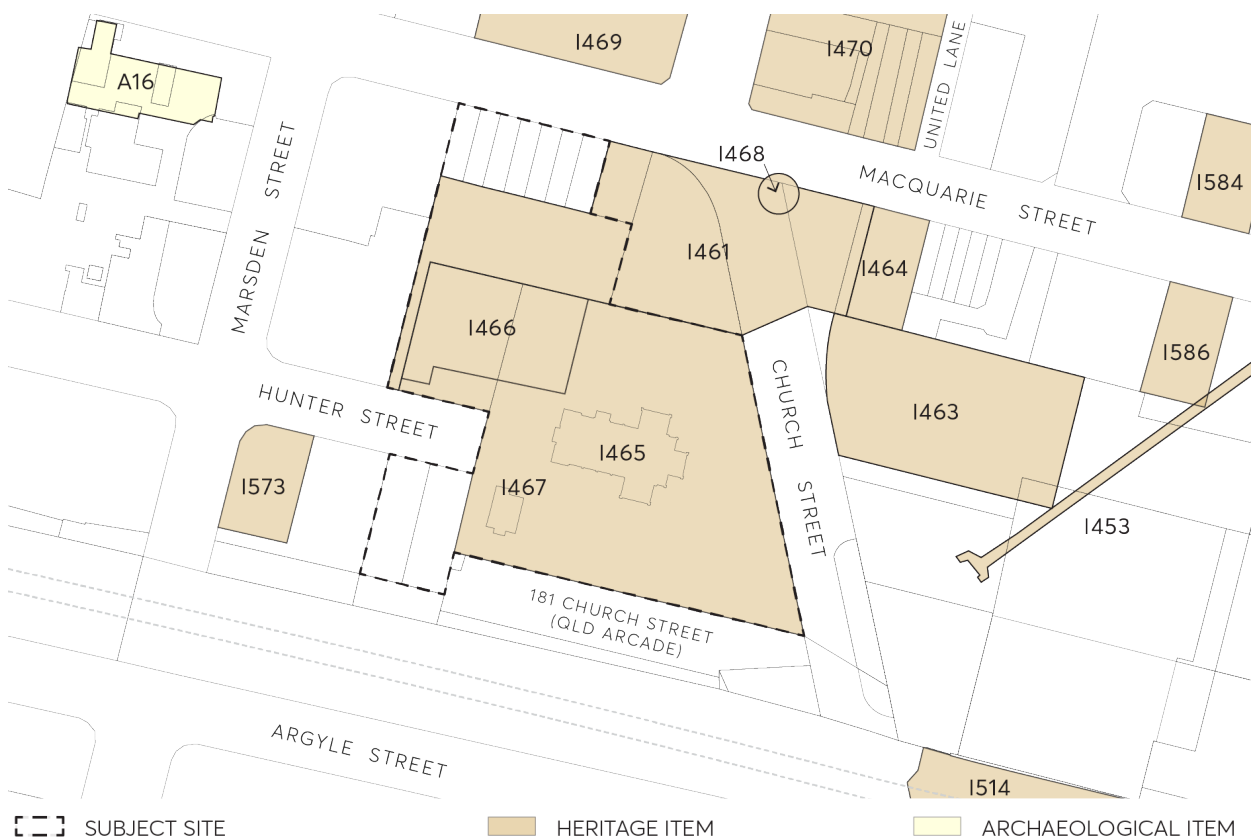

Figure 9.10.21.4 – State and local heritage items in the vicinity of St John's Anglican Cathedral, Parramatta

General Objectives

- O.01 Ensure that new development of the land owned by the Anglican Church is congruent with the heritage values of the Cathedral complex and appropriate in the context of the heritage items located within the vicinity of the site.
- O.02 Ensure that the Cathedral complex retains its preeminent status in the City Centre. New development does not reduce the importance of the Cathedral complex in its immediate context, or the landmark quality of the Cathedral.
- O.03 New development retains the relationships between the Cathedral complex and the historic buildings of Centenary Square as well as broader relationships within the City Centre.
- O.04 Provide an appropriate setting for St John's Anglican Cathedral, the former Warden's Cottage (Verger's Cottage), and St John's Building on the site of any new development. This includes the retention of existing significant trees, an enhancement of the existing setting by the removal of at-grade car parking, and the ongoing incorporation of the land around the Cathedral complex into the public domain of Centenary Square.
- O.05 Ensure new development responds appropriately to its historic context, including the historic street pattern.

9.10.21.3.2 UNDERSTANDING THE PLACE

Objectives

- O.01 Ensure the heritage values of St John's Anglican Cathedral complex, including the Warden's Cottage (Verger's Cottage), the St John's Building, and the existing grounds are well understood to inform any future redevelopment.
- O.02 Ensure the important relationships between St John's Anglican Cathedral complex and City Centre, including heritage listed places, the historic street pattern and broader historic landscape context, are well understood to inform any future redevelopment.
- O.03 Ensure the archaeological resources of the place determined through early archaeological test excavations and incorporated into the Archaeological report inform the detailed design for the site. of the excavations are incorporated into the detailed design.

Controls

- C.01 The relationship between the St John's Anglican Cathedral complex, the adjacent heritage items, broader City Centre and landscape context must be set out within a heritage impact statement submitted with the Development application and Council-supported Conservation Management Plan prepared for the St John's Anglican Cathedral complex. This explanation must include a views analysis, analysis of relationships with Centenary Square and the new Parramatta Square, and assessment of the historic landscape context.
- C.02 The recommendations of the Archaeological report (that includes the results of the test excavations) are to be incorporated into the detailed design. This includes the conservation of local and State significant archaeology. Where this is not possible or practical, excavation,

salvage, reuse and/or interpretation of the archaeology in accordance with an approved archaeological research design and excavation methodology is to occur.

9.10.21.3.3 HERITAGE RELATIONSHIPS

Objectives

- O.01 A detailed curtilage (setting) should be retained around the Cathedral complex, in particular the St John's Anglican Cathedral, such that the building can continue to be a dominant civic element. The St John's Anglican Cathedral should not be "crowded" by new development.
- O.02 The site of St John's Anglican Cathedral complex should continue to provide open pedestrian access within the subject site and enhancing permeability through the City Centre. In particular, development should encourage pedestrian access around heritage buildings and features.
- O.03 Retain and enhance the important relationships between St John's Anglican Cathedral complex and City Centre, including the retention and enhancement of publicly accessible grounds around the Cathedral.
- O.04 Create appropriate relationships between new development (northern and southern towers, public domain and Hunter Street) and heritage items, in a way that retains and enhances the heritage value of the place and the City Centre.

Controls

- C.01 A defined curtilage (setting) must be retained around St John's Anglican Cathedral complex, in particular the Cathedral so that the building can continue to be a dominant element. The Cathedral must not be "crowded" by new development.
- C.02 The site of St John's Anglican Cathedral complex must continue to provide open pedestrian access within the subject site. In particular, development must encourage pedestrian access around heritage buildings and features.
- C.03 The Warden's Cottage (Verger's Cottage) should be set in its own fenced garden, the extent to match the historical extent. The existing faux heritage fence must be replaced with one to match the original.
- C.04 If the eastern end of Hunter Street is incorporated into the open space around the Cathedral complex, this space should be publicly accessible and designed in response to and to enhance the setting of adjacent heritage buildings, in particular, St John's Anglican Cathedral. The public domain design should ensure that the enlarged public space has a primary relationship with St John's Anglican Cathedral.
- C.05 Development on the subject site must maintain historical views to and from heritage buildings, where they still exist.
- C.06 Setbacks and landscaping are to be designed to protect and enhance key views to St John's Anglican Cathedral. Setbacks should reinforce key views of St John's Anglican Cathedral along the alignment of Church Street, Parramatta Square and Hunter Street.

- C.07 Vehicular parking should not be provided at ground level. On grade vehicular access and temporary parking can be provided for Parish activities (such as weddings and funerals). Vehicle access is to have minimal visual impact.
- C.08 If a driveway is required from Hunter Street to access either the Northern or Southern tower buildings, it should be located on that part of the site furthest from St John's Anglican Cathedral.
- C.09 The podium level facades of future development fronting the Cathedral, Cathedral open spaces and Centennial Square should be of restrained design so that the facades are not visually intrusive in the setting of the historic buildings on the site or in relation to the landscape of the complex, in particular, the Cathedral and the Hunter Street forecourt. The design must incorporate (but not be limited to) the following measures to manage potential visual impact:
- a) The podium must have a regular form, a regular pattern of openings and limited decorative details.
 - b) The parapet of the podium must have a horizontal top without any stepping.
 - c) The eastern façade must have a high proportion of solid to opening.
 - d) Materials and colours must be limited in range, and carefully selected to help ensure a restrained ("quiet") facade.
 - e) The eastern and southern facades of the podium must not have awnings.
 - f) The eastern façade of the podium must not have an active frontage.
 - g) Active uses such as outdoor dining and the like, if desired near the southern façade must not be located such that they would face into the area of the existing western forecourt of the Cathedral. They must instead be located in that part of the site facing into Hunter Street, or in the case that the eastern end of Hunter Street is incorporated into a public space, where Hunter Street was previously located.
 - h) Signage must be restrained and restricted to the ground floor. There must be few, if any, signs on the eastern and southern façades.
- C.10 Any changes in ground level must occur within the building footprint, not in the public domain or external spaces. If the ground level needs to be for flood reasons, this must be within the building footprint. The existing relationship of heritage buildings to existing ground levels must not be altered.
- C.11 New development must be undertaken in accordance with the conservation policies of a Conservation Management Plan that has been accepted by Council.
- C.12 New signage should be restrained and designed contextually in relation to the heritage values, should be consistent across the development and should not be visually intrusive.
- C.13 Future development of the St John's Building should involve retaining the whole of the parapeted section of the building as a minimum. The junction between the retained section of the building and new development should be a single storey visually recessive element that does not directly adjoin a new tower building. No new openings are to be made in the retained facades of the existing building and awning must not be added.

9.10.21.3.4 ARCHIVAL RECORDING

Objective

- O.01 Undertake an archival recording of the site and buildings to ensure that a record of the whole of the place is undertaken prior to any works commencing.

Control

- C.01 Prepare an archival recording of the site.

9.10.21.3.5 AMALGAMATION OF LOTS AND LANDSCAPE SETTING

Objective

- O.01 Retain the setting and relationship of the heritage items on the site irrespective of possible site amalgamation.

Controls

- C.01 Irrespective of lot amalgamations or adjustments, the setting of the heritage buildings on the site is to be managed to retain the place as an integrated group of elements with new development responding to the heritage setting and form of the site. Essential to this concept is ensuring that the public spaces principally are designed in relation to the cathedral building, then to the other heritage elements and finally in response to the new built elements on the site. The St John's Anglican Cathedral Building should retain primacy in future development.
- C.02 A detailed design is to be submitted for the public domain around the St John's Anglican Cathedral. The public domain must include deep soil planted areas and vegetated areas in order to reflect the historic landscape setting of the St John's Anglican Cathedral. Existing significant trees should be retained. New tree plantings and landscape elements are to first reinforce the Cathedral in its setting and secondarily integrate with new built form and open spaces.
- C.03 Excavation should not adversely impact the structural stability or heritage fabric of heritage items, nor adversely affect the health of existing significant trees. A report from a suitably qualified and experienced structural engineer must be submitted attesting that excavation work will not impact the built and decorative elements of heritage items. An arborist's report should be submitted attesting that the excavation will not affect the health of retained trees.\
- C.04 Ventilation structures must not be located in outdoor areas that are public spaces or accessible to the public.
- C.05 Any proposed underground car park and associated driveway must be acoustically isolated from St John's Anglican Cathedral, such that the use of the carpark and driveways cannot be heard or felt in the St John's Anglican Cathedral, Warden's Cottage, St John's Parish Hall or in any new publicly accessible space to the western side of the Cathedral.

9.10.21.3.6 DEVELOPMENT TO BENEFIT A HERITAGE ITEM

Objectives

- O.01 Conserve heritage items through appropriate conservation works.
- O.02 Set out and undertake appropriate conservation works to ensure the future of heritage elements.
- O.03 Develop a long-term conservation program for the site and its heritage elements that is adequately funded.

Controls

- C.01 A detailed schedule of conservation works including detail drawings, is to be submitted as a component of the Stage 2 DA for the retained heritage buildings and elements, including St John's Anglican Cathedral, St John's Building, Warden's Cottage and memorial gateway.
- C.02 The conservation works must be overseen and signed-off as acceptable by a heritage architect. The name, qualifications and experience of the heritage architect who will oversee and sign-off on the conservation works must be submitted. The methodology for exactly how the heritage architect will oversee the works must be submitted.

9.10.21.3.7 INTERPRETATION

Objectives

- O.01 Interpretation of the heritage values of the place is to be undertaken through the process of a Heritage Strategy and Heritage Interpretation Plan. Key values include understanding the heritage significance of St John's Anglican Cathedral as the oldest Church site and continuous place of Christian worship in Australia.

Controls

- C.01 Interpret the heritage values of the St John's Anglican Cathedral complex in a way that does not adversely impact the heritage items or their setting. Any heritage interpretation that is part of proposed new buildings should be integrated into the design of the site and any new buildings.
- C.02 A Heritage Interpretation Strategy as well as a detailed draft Heritage Interpretation Plan must be submitted. They are to be derived from the heritage values of the site, and prepared in accordance with relevant guidelines and policy, as follows:
 - A Conservation Management Plan that has been determined by Council's Heritage Officer as being suitable for the St John's Cathedral complex.
 - NSW Heritage Manual;
 - NSW Heritage Branch Interpreting Heritage Places and Items: Guidelines (August 2005);

- NSW Heritage Branch Heritage Interpretation Policy (endorsed by the Heritage Council August 2005); and
 - Australia ICOMOS Burra Charter 2013.
- C.03 The formalisation of the Heritage Interpretation Plan will be undertaken during the development assessment process in consultation with Council. The final design of the interpretation would be subject to detailed design development so to integrate interpretation within the future development of the site in a way that respects the heritage value of the place, is appropriate to its context, and is not visually intrusive.
- C.04 In the case that the eastern end of Hunter Street is incorporated into new public space, the former location of Hunter Street must be interpreted in a subtle way in the new public space.

9.10.21.4 PUBLIC DOMAIN

This Section of this DCP must be read in conjunction with the Parramatta [Public Domain Guidelines 2017](#) and Section 9.4 – Public Domain of Parramatta DCP 2023.

The controls in Section 9.4 – Public Domain consolidate and update the public domain controls for the City Centre and, where there is an inconsistency between the public domain controls and objectives in this Section and other Parts of this DCP, this Section prevails.

Before lodging a Development Application early consultation with Council is encouraged to formulate an agreed design brief and public domain design. Design Submission Requirements are to be prepared in accordance the Parramatta [Public Domain Guidelines 2017](#).

Objectives

- O.01 Provide open spaces that are designed in relation to and which provide for a liturgical, parish and functional needs of St John's Anglican Cathedral.
- O.02 Provide open spaces that are publicly accessible and are complementary to the existing Parramatta Square and Centenary Square.
- O.03 Contribute to connectivity and legibility within the City Centre including reinforcement of the historic pattern of development in the City Centre and ensuring that development is integrated with Parramatta's urban structure.
- O.04 Provide activation of publicly accessible spaces through church use and a diverse mix of others uses.
- O.05 Provide a comfortable microclimate within the open spaces.
- O.06 Provide safe, at-grade vehicle access across pedestrian areas to the existing and proposed buildings.
- O.07 Engage with Council regarding the open space design on the Western side of St John's Anglican Cathedral prior to lodgement of the Development Application.

Controls

- C.01 Council approval of an agreed detailed design brief and public domain design must be achieved before submission of a Development Application. The Applicant is to liaise with Council at 50% and 90% completion of the public domain design prior to lodgement of the Development Application.
- C.02 The set-out of public domain and new built form at ground level shall be consistent with Figure 9.10.21.5. The new St John's public domain shall be framed by new buildings set back 20 metres from the centreline of St John's Anglican Cathedral and Parramatta Square.

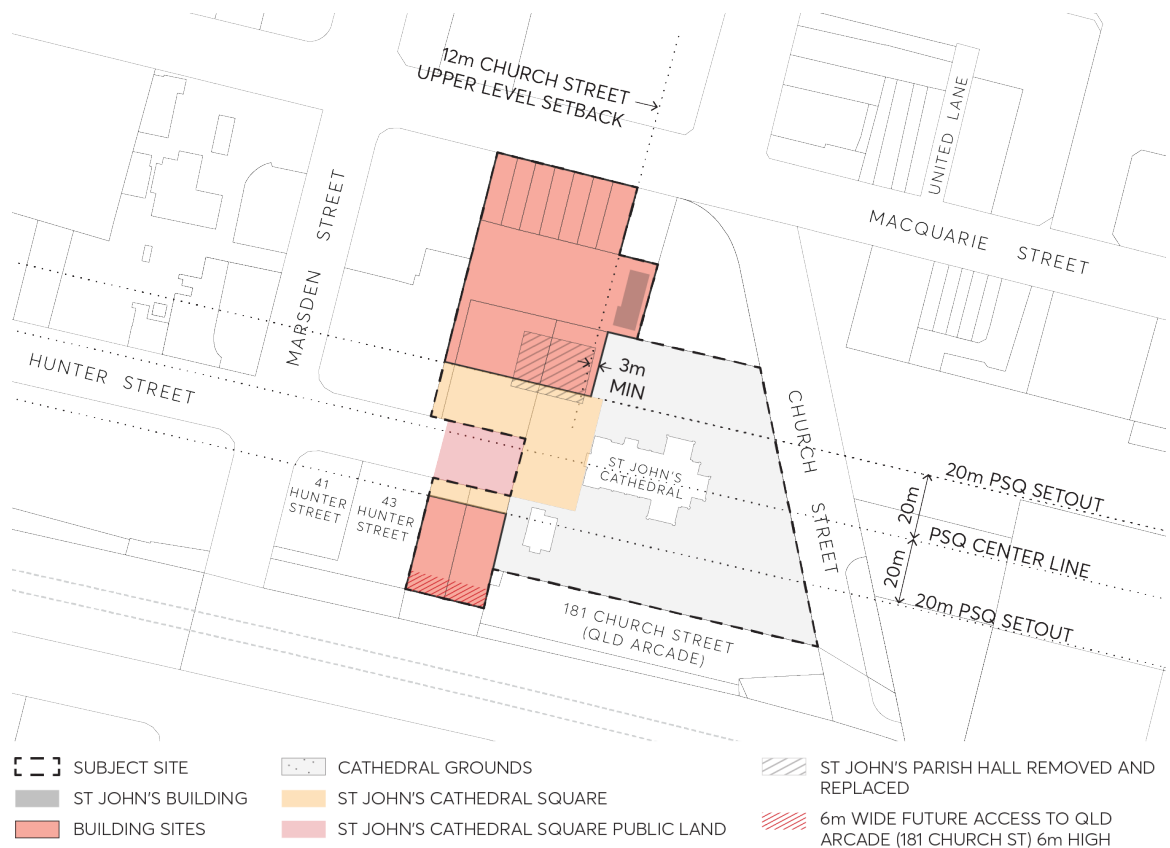

Figure 9.10.21.5 – Public domain set-out plan for Option A

- C.03 Pedestrian access through the open space between Church Street and Hunter Street shall be open to the public 24/7, where possible, whilst providing for the requirements of St John's Anglican Cathedral.
- C.04 Tree planting shall be provided within the public domain that is appropriate to its role, respectful of sight lines including from Hunter Street facing St John's Anglican Cathedral and at a scale that is appropriate to a setting for the St John's Anglican Cathedral. Trees shall be planted at natural (pre new development maximum) ground level, not in raised planters. The size of trees shall be maximized, within the considerations otherwise outlined in this control.
- C.05 A minimum soil depth of 1 metre (excluding structural, drainage and mulch layers) above any basement structure shall be provided for all trees, in contiguous planting pits. Minimum soil

volumes for trees on podiums over basements are to be provided according to the [Apartment Design Guide](#).

- C.06 Spaces for public seating shall be provided in a range of locations and to suit different users.
- C.07 Designs shall demonstrate the ability to accommodate a range of uses and activities including servicing requirements in the new public domain, including Parish of Parramatta events such as weddings and funerals and public events.

9.10.21.5 BUILT FORM

This Section of this DCP must be read in conjunction with:

- Section 9.3 – Built Form
- Clause 7.3 Floor space ratio, Clause 7.7 Sun access, Clause 7.23 End of journey facilities, and Clause 7.10 Active frontages in *Parramatta LEP 2023*.

Where there is an inconsistency between the built form controls and objectives in this Section and other Sections of this DCP, this Section prevails.

Objectives

- O.01 Ensure built form outcomes respond to the heritage significant of the site.
- O.02 Ensure built form outcomes that respond to the human scale around St John's Anglican Cathedral, the associated public domain, other heritage items, existing buildings and any proposed street walls.
- O.03 Ensure that street walls of new buildings frame the public domain through appropriate design, scale, and materiality to reflect the primacy of St John's Anglican Cathedral within the overall site.
- O.04 Respond to view corridors including those towards St John's Anglican Cathedral along Church Street, Parramatta Square and Hunter Street.
- O.05 Provide appropriate solar access to the public domain compliant with *Parramatta LEP 2023*.
- O.06 The built form is to provide for flexible and efficient commercial floorplates, whilst satisfying the heritage objectives of this DCP.
- O.07 Provide appropriate building separation to neighbouring sites.
- O.08 Provide weather and wind protection to the open spaces.
- O.09 Ensure architectural responses make a high-quality contribution to the setting and urban design of the area consistent with Council's design excellence policies.
- O.10 Ensure built form outcomes respond to any adjacent buildings or likely future envelopes on neighbouring sites to enable informed consideration of suitable setbacks, built form, access and public domain outcomes as well as amenity impacts.
- O.11 Provide a tall, slender tower on the Northern development site by requiring a splayed edge on the north-eastern Macquarie Street/Centenary Square corner of the tower to reduce the mass

and presence of the tower on the civic spaces and open up views across the podium to the street and sky.

Controls

- C.01 Development Applications for new buildings within the St John's Anglican Cathedral complex site must comply with the controls in Section 9.3 – Built Form unless adjusted by the controls below.
- C.02 Street wall or podium interfaces of new development must comply with the following:
- a) Street wall heights to the public domain areas in front of St John's Anglican Cathedral should be in the range of 14-16m in height. The exact height of street walls is to be underpinned by detailed heritage, urban design, and architectural analysis.
 - b) DCP controls in Section 9.3 – Built Form must be applied to determine the outcomes for the Macquarie Street of the podium at the Northern development site, including analysis requirements found in Section 9.4.4 – The Street Wall.
 - c) Resolution of the eastern podium interface at the Northern development site is subject to Section 9.10.21.3 – Heritage of this DCP.
- C.03 The southern and western setback of the Northern development site tower must be a minimum of 6 metres from the podium edge.
- C.04 The eastern setback of the Northern development site tower must not encroach the Church Street upper-level setback line in *Parramatta LEP 2023*.
- C.05 The eastern setback of the Northern development site tower must ensure compliance with the solar access requirement for Parramatta Square set out in Clause 7.7 Sun access of *Parramatta LEP 2023*.
- C.06 The design of basement entry and exit points including any ramps to access lower levels must be contained within the building envelope where possible. No dive structures are permitted within Council owned land and within the open space areas around the Cathedral.
- C.07 If site amalgamation of 41, 43 and 45 Hunter Street can not be achieved, additional massing up to one (1) storey above the specified street wall may be considered for the Southern development site where amenity and heritage impacts can be satisfied and the additional storey is setback a minimum 6 metres from Hunter Street, and the eastern, southern and western setbacks are established through detailed urban design and architectural analysis taking into consideration potential development at 41-43 Hunter Street and the surrounding heritage context. Any upper-level addition above the specified street wall should apply construction methods and materiality which reinforce a lightweight and recessive appearance to the architecture above the street wall.
- C.08 The height and design of the street wall/podium at the base of both the northern and southern development sites must respond to the varying interface conditions (street, squares, heritage, and open space). For the Northern development site, development above the podium shall not encroach the PSQ SAP Angle at 2pm mid-winter solstice line shown in Figure 9.10.21.6 to ensure a well-proportioned commercial tower that is tall and slender allowing views across the podium to the surrounding streets and sky from Centenary Square.

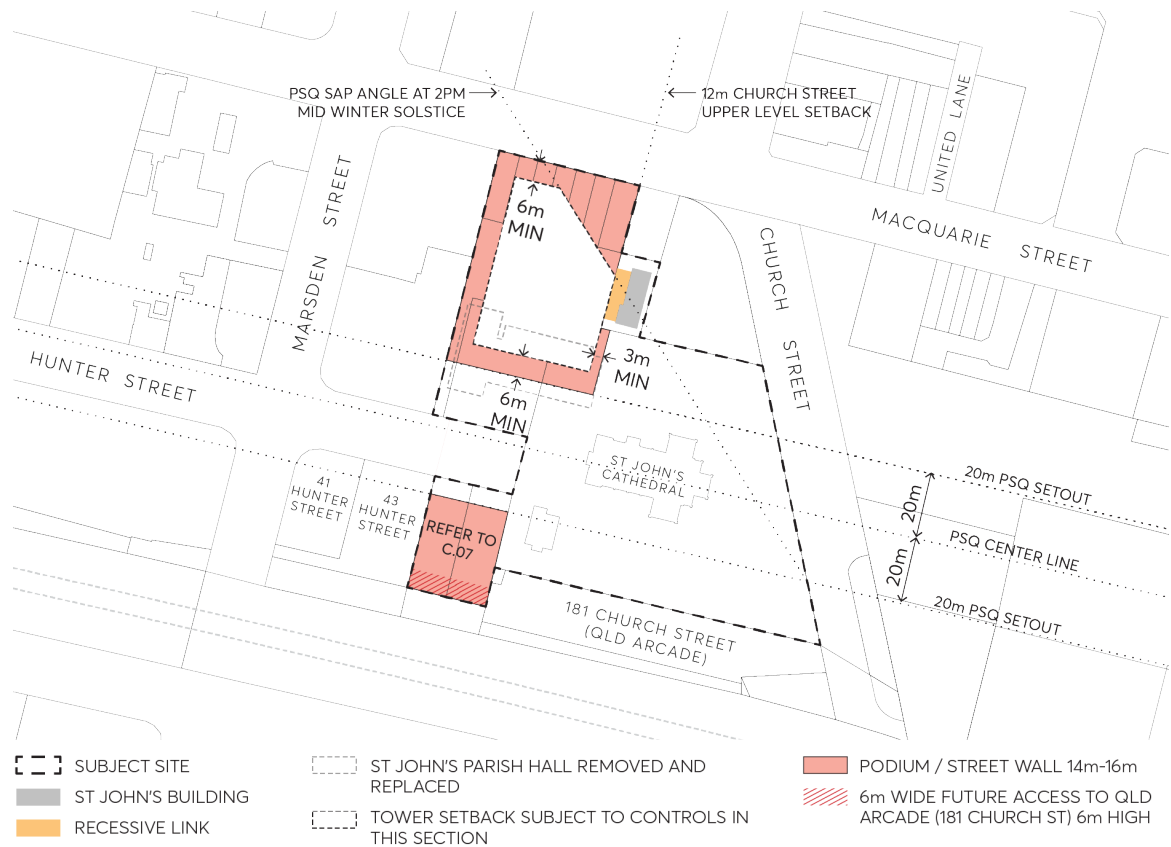

Figure 9.10.21.6 – Built Form set-out plan for Option A

OPTION B - ST JOHN'S PARISH HALL PARTIALLY RETAINED

9.10.21.6 DESIRED FUTURE CHARACTER

St John's Anglican Cathedral occupies a prominent site in the heart of the City Centre. It is the oldest Church site and continuous place of Christian worship in Australia dating from 1803. Development of the site is congruent with the Cathedral's State heritage significance. This DCP supports the on-going role and heritage significance of St John's Anglican Cathedral, as a landmark site in the City Centre.

Development of the site must enhance the heritage values associated with the St John's Anglican Cathedral, and the immediate surrounds. The site extends the open spaces created by Parramatta Square and Centenary Square, framed by built form around the Cathedral with buildings positioned to maintain solar access to the key public open spaces. St John's Anglican Cathedral is reinforced as the focal point for key views following the alignment of Church Street and Parramatta Square. The open space around the Cathedral accommodates the use of the Cathedral as a place of Anglican worship and provides for general movement.

Building design achieves elegant, contextually responsive forms that contribute to the significance of the area and reinforce the character of Parramatta as a centre for employment, business, and living. New buildings enhance activation of the spaces around St John's Anglican Cathedral connecting with the Parish facilities of the Church, with the southern development site comprising

of an amalgamation with 41 and 43 Hunter Street in order for any future development to achieve adequate amenity and appropriate relationships to the heritage context of the Cathedral complex.

The heritage values of the site as a whole and the significant built elements including the Cathedral Building, St John's Parish Hall, the St John's Building, and the former Vergers Cottage are enhanced by development.

Site objectives

- O.01 Provide an enhanced and recovered setting for St John's Anglican Cathedral and the associated public domain that is sensitive to the heritage significance of the site and its significant elements.
- O.02 Deliver employment uses within the City Centre that contribute to Parramatta's employment objectives.
- O.03 Deliver a civic response through the provision of access and public domain upgrades.
- O.04 Facilitate the continued use of the site for religious Anglican worship supported by contemporary spaces for the Parish of Parramatta to support their ongoing use of the place.
- O.05 Balance active street frontages and flood mitigation requirements.
- O.06 Enhance the heritage significance of St John's Parish Hall, Warden Cottage (Verger's Cottage), St John's Building and the Bicentennial Square heritage listing, to communicate the historical evolution of the landmark site between St John's Anglican Cathedral and contemporary development.

9.10.21.7 HERITAGE

This Section of this DCP must be read in conjunction with:

- Section 9.6 – Heritage
- Part 7 – Heritage and Archaeology
- Clause 7.22 Managing heritage impacts of *Parramatta LEP 2023*

Where there is an inconsistency between the heritage controls and objectives in this Section and other Parts of this DCP, this Section prevails.

9.10.21.7.1 HERITAGE LISTINGS

State heritage listing

- The subject site contains a State heritage item known as St John's Anglican Cathedral (SHR ID 01805)

Local heritage listing

- St John's Anglican Cathedral (item no. I465)
- St John's Parish Hall (item no.I466)
- Warden's Cottage (Verger's Cottage) (item no.I467)
- Bicentennial Square and adjoining buildings (item no.I461)
- St John's Building at 38 Hunter Street (included in the Bicentennial Square heritage listing)

The subject site is in the vicinity of several state and locally listed heritage items, including:

- Centenary Square and adjoining buildings (item no.I461).
- Murray's Building (and potential archaeological site) (item no.I464)
- Centennial Memorial Clock (item no.I468)
- Parramatta Town Hall (and potential archaeological site) (item no.I463)
- Shop (and potential archaeological site) (item no.I469)
- Two-storey residence, No. 41 Hunter Street (item no.I573)

The *Parramatta LEP 2023* sets out the controls for development within the vicinity of heritage items.

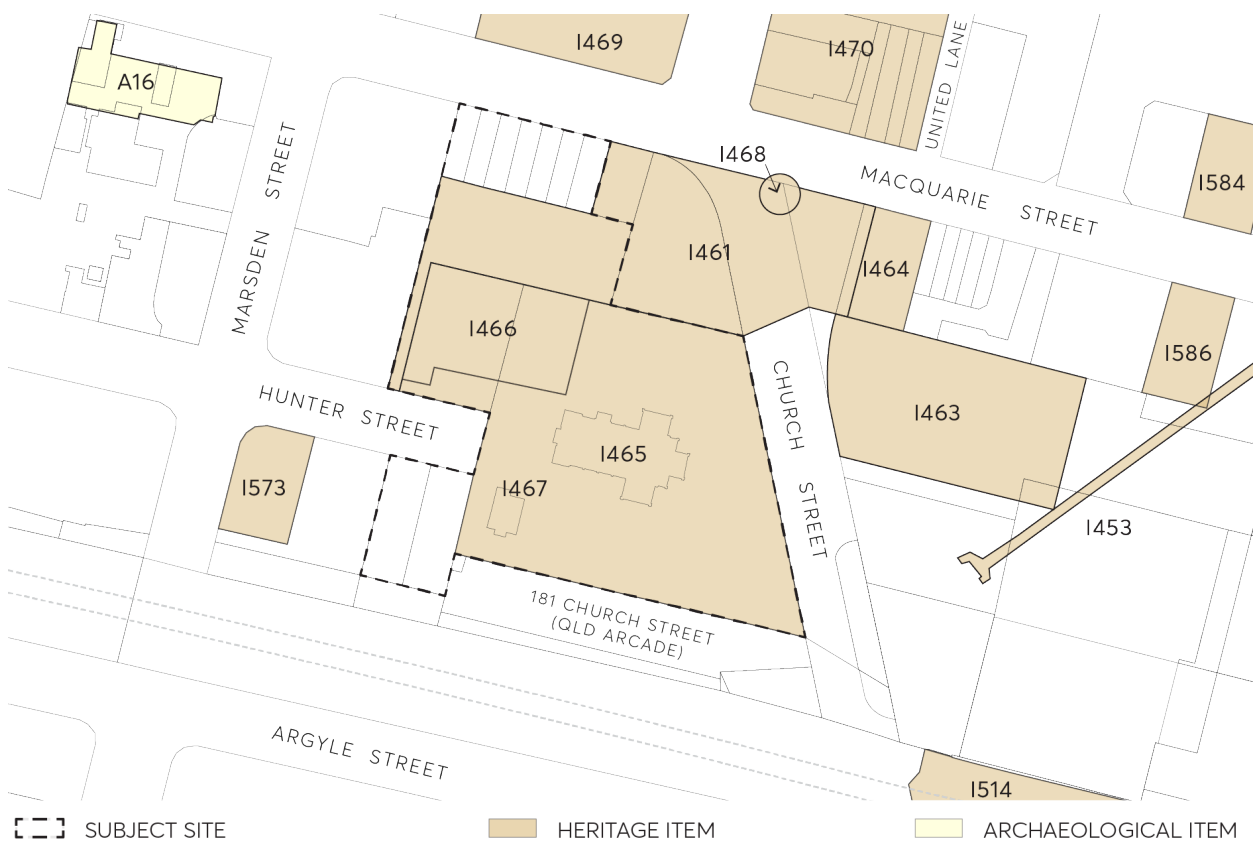

Figure 9.10.21.7 – State and local heritage items in the vicinity of St John's Anglican Cathedral, Parramatta

General Objectives

- O.01 Ensure that any new development of the land owned by the Anglican Church is congruent with the heritage values of the Cathedral complex and appropriate in the context of the heritage items located within the vicinity of the site.
- O.02 Retain the Cathedral complex's preeminent status in the City Centre. New development does not reduce the importance of the St John's Anglican Cathedral complex in its immediate context, or the landmark quality of the Cathedral.
- O.03 Ensure that new development retains the relationships between the St John's Anglican Cathedral complex and the historic buildings of Centenary Square as well as broader relationships within the City Centre.
- O.04 Provide an appropriate setting for St John's Anglican Cathedral, St John's Parish Hall, the former Warden's Cottage (Verger's Cottage), and the St John's Building in any new development. This includes the retention of existing significant trees, an enhancement of the existing setting by the removal of at-grade car parking, and the usage of the land around the Cathedral complex for pedestrian access into the public domain of Centenary Square.
- O.05 Ensure new development responds appropriately to its historic context, including the historic street pattern.

9.10.21.7.2 UNDERSTANDING THE PLACE

Objectives

- O.06 Ensure the heritage values of St John's Anglican Cathedral complex, including the Warden's Cottage (Verger's Cottage), the St John's Building, and the existing grounds are well understood to inform any future redevelopment.
- O.07 Ensure the important relationships between St John's Anglican Cathedral complex and City Centre, including heritage listed places, the historic street pattern and broader historic landscape context, are well understood to inform any future redevelopment.
- O.08 Ensure the archaeological resources of the place determined through early archaeological test excavations and incorporated into the Archaeological report inform the detailed design for the site. of the excavations are incorporated into the detailed design.

Controls

- C.01 The relationship between the St John's Anglican Cathedral complex, the adjacent heritage items, broader City Centre and landscape context must be set out within a heritage impact statement submitted with the Development application and Council-supported Conservation Management Plan prepared for the St John's Anglican Cathedral complex. This explanation must include a views analysis, analysis of relationships with Centenary Square and the new Parramatta Square, and assessment of the historic landscape context.
- C.02 The recommendations of the Archaeological report (that includes the results of the test excavations) are to be incorporated into the detailed design. This includes the conservation of

local and State significant archaeology. Where this is not possible or practical, excavation, salvage, reuse and/or interpretation of the archaeology in accordance with an approved archaeological research design and excavation methodology is to occur.

9.10.21.7.3 HERITAGE RELATIONSHIPS

Objectives

- O.01 Ensure the retention and enhancement of the landmark quality of St John's Anglican Cathedral and the preeminent status of the Cathedral complex in the City Centre.
- O.02 Retain and enhance the relationship between the different components of St John's Anglican Cathedral complex, and the contribution they make to the heritage values of the place.
- O.03 Retain and enhance the important relationships between St John's Anglican Cathedral complex and City Centre, including the retention and enhancement of publicly accessible grounds around the Cathedral.
- O.04 Create appropriate relationships between new development (northern and southern towers, public domain and Hunter Street) and heritage items, in a way that retains and enhances the heritage value of the place and the City Centre.

Controls

- C.01 A detailed curtilage (setting) should be retained around the Cathedral complex, in particular the St John's Anglican Cathedral, such that the building can continue to be a dominant element. The St John's Anglican Cathedral must not be "crowded" by new development.
- C.02 The site of St John's Anglican Cathedral complex must continue to provide open pedestrian access within the subject site. In particular, development must encourage pedestrian access around heritage buildings and features.
- C.03 The Warden's Cottage (Verger's Cottage) should be set in its own fenced garden, the extent to match the historical extent. The existing faux heritage fence must be replaced with one to match the original.
- C.04 If the eastern end of Hunter Street is incorporated into the open space around the Cathedral complex, this space should be publicly accessible and designed in response to and enhance the setting of adjacent heritage buildings, in particular, St John's Anglican Cathedral. The public domain design should ensure that the enlarged public space has a primary relationship with St John's Anglican Cathedral.
- C.05 Development on the subject site must maintain historical views to and from heritage buildings, where they still exist.
- C.06 Setbacks and landscaping are to be designed to protect and enhance key views to St John's Anglican Cathedral. Setbacks should reinforce key views of St John's Anglican Cathedral along the alignment of Church Street, Parramatta Square and Hunter Street.

- C.07 Vehicular parking should not be provided at ground level. On grade vehicular access and temporary parking can be provided for Parish activities (such as weddings and funerals). Vehicle access is to have minimal visual impact.
- C.08 If a driveway is required from Hunter Street to access either the Northern or Southern tower buildings, it should be located on that part of the site furthest from St John's Anglican Cathedral.
- C.09 The podium level facades of future development fronting the Cathedral, Cathedral open spaces and Centenary Square should be of restrained design so that the facades are not visually intrusive in the setting of the historic buildings on the site or in relation to the landscape of the complex, in particular, the Cathedral and the Hunter Street forecourt. The design must incorporate (but not be limited to) the following measures to manage potential visual impact:
- a) The podium must have a regular form, a regular pattern of openings and limited decorative details.
 - b) The parapet of the podium should have a horizontal top without any stepping.
 - c) The eastern façade of the podium must not have an active frontage.
 - d) Materials and colours should be limited in range, and carefully selected to help ensure a restrained (quiet) design of the facade.
 - e) Signage must be restrained and restricted to the ground floor. There must be few, if any, signs on the eastern and southern façades
- C.10 The St John's Parish Hall and new podium/tower interface is to be designed to ensure that the hall building retains its integrity and form. Potential connections between these elements are to be designed to ensure that the hall building retains its setting within the overall open space of the site, and does not butt up hard against the new tower building but must be separated by at least 3 metres, and may include a link formed between the two buildings that is visually recessive, preferably glazed.
- C.11 Future development of the St John's Building should involve retaining the whole of the parapeted section of the building as a minimum. The junction between the retained section of the building and new development should be a single storey visually recessive element that does not directly adjoin a new tower building. No new openings are to be made in the retained facades of the existing building.
- C.12 Changes in ground level should occur within the building footprint, not in the public domain or external spaces. If the ground level needs to be raised for flood reasons, this is to be designed within the building footprint. The existing relationship of heritage buildings to existing ground is to be generally retained.
- C.13 New development must be undertaken in accordance with the conservation policies of a Conservation Management Plan that has been accepted by Council.
- C.14 Existing unsympathetic alterations to St John's Hall as detailed in a schedule of conservation works must be reversed.
- C.15 In the case that the historic part (c.1910) of St John's Parish Hall is retained, active uses are not appropriate, in particular, outdoor dining or noisy venues.

- C.16 In the case that the latter additions to St John's Parish Hall are removed, the new wall to enclose the hall should respect the heritage values of the hall.
- C.17 New signage must be restrained and restricted. It must not be visually intrusive in the setting of the historic buildings. Drawings of all signage must be submitted. Existing signage, including interpretation signage, must be removed if it is inconsistent with a new signage approach or if it detracts from the setting of a heritage item.

9.10.21.7.4 ARCHIVAL RECORDING

Objective

- O.01 Undertake an archival recording of the site and buildings to ensure that a record of the whole of the place is undertaken prior to any works commencing.

Control

- C.01 Prepare an archival recording of the site.

9.10.21.7.5 AMALGAMATION OF LOTS AND LANDSCAPE SETTING

Objective

- O.01 Retain the setting and relationship of the heritage items on the site irrespective of possible site amalgamation.

Controls

- C.01 Irrespective of lot amalgamations or adjustments, the setting of the heritage buildings on the site is to be managed to retain the place as an integrated group of elements with new development responding to the heritage setting and form of the site. Essential to this concept is ensuring that the public spaces principally are designed in relation to the cathedral building, then to the other heritage elements and finally in response to the new built elements on the site. The St John's Anglican Cathedral Building should retain primacy in future development.
- C.02 A detailed design is to be submitted for the public domain around the St John's Anglican Cathedral. The public domain must include deep soil planted areas and vegetated areas in order to reflect the historic landscape setting of the St John's Anglican Cathedral. Existing significant trees should be retained. New tree plantings and landscape elements are to first reinforce the Cathedral in its setting and secondarily integrate with new built form and open spaces.
- C.03 Excavation should not adversely impact the structural stability or heritage fabric of heritage items, nor adversely affect the health of existing significant trees. A report from a suitably qualified and experienced structural engineer must be submitted attesting that excavation

work will not impact the built and decorative elements of heritage items. An arborist's report should be submitted attesting that the excavation will not affect the health of retained trees.

- C.04 Ventilation structures must not be located in outdoor areas that are public spaces or accessible to the public.
- C.05 Any proposed underground car park and associated driveway must be acoustically isolated from St John's Anglican Cathedral, such that the use of the carpark and driveways cannot be heard or felt in the St John's Anglican Cathedral, Warden's Cottage, St John's Parish Hall or in any new publicly accessible space to the western side of the Cathedral.

9.10.21.7.6 DEVELOPMENT TO BENEFIT A HERITAGE ITEM

Objectives

- O.01 Conserve heritage items through appropriate conservation works.
- O.02 Set out and undertake appropriate conservation works to ensure the future of heritage elements.

Controls

- C.01 A detailed schedule of conservation works including detail drawings, is to be submitted as a component of the Stage 2 DA for the retained heritage buildings and elements, including St John's Anglican Cathedral, St John's Building, Warden's Cottage and memorial gateway.
- C.02 The conservation works must be overseen and signed-off as acceptable by a heritage architect. The name, qualifications and experience of the heritage architect who will oversee and sign-off on the conservation works must be submitted. The methodology for exactly how the heritage architect will oversee the works must be submitted.

9.10.21.7.7 INTERPRETATION

Objectives

- O.01 Interpretation of the heritage values of the place is to be undertaken through the process of a Heritage Strategy and Heritage Interpretation Plan. Key values include understanding the heritage significance of St John's Anglican Cathedral as the oldest Church site and continuous place of Christian worship in Australia.

Controls

- C.01 Interpret the heritage values of the St John's Anglican Cathedral complex in a way that does not adversely impact the heritage items or their setting. Any heritage interpretation that is part of proposed new buildings should be integrated into the design of the site and any new buildings.

- C.02 A Heritage Interpretation Strategy is to be prepared to inform the architectural design competition.
- C.03 A Heritage Interpretation Plan is to be developed and provided as part of the Stage 2 DA arising from the architectural design competition.
- C.04 The documents are to be derived from the heritage values of the site, and prepared in accordance with relevant guidelines and policy, as follows:
- A Conservation Management Plan that is accepted by Council;
 - NSW Heritage Manual;
 - NSW Heritage Branch Interpreting Heritage Places and Items: Guidelines (August 2005);
 - NSW Heritage Branch Heritage Interpretation Policy (endorsed by the Heritage Council August 2005); and
 - Australia ICOMOS Burra Charter 2013.

9.10.21.8 PUBLIC DOMAIN

This Section of this DCP must be read in conjunction with the Parramatta [Public Domain Guidelines 2017](#) and Section 9.4 – Public Domain of Parramatta DCP 2023.

Before lodging a Development Application early consultation with Council is encouraged to formulate an agreed design brief and public domain design. Design Submission Requirements are to be prepared in accordance the Parramatta [Public Domain Guidelines 2017](#).

Objectives

- O.01 Provide open spaces that are designed in relation to and which provide for a liturgical, parish and functional needs of St John's Anglican Cathedral.
- O.02 Provide open spaces that are publicly accessible and are complementary to the existing Parramatta Square and Centenary Square.
- O.03 Contribute to connectivity and legibility within the City Centre including reinforcement of the historic pattern of development in the City Centre and ensuring that development is integrated with Parramatta's urban structure.
- O.04 Provide activation of publicly accessible spaces through church use and a diverse mix of others uses.
- O.05 Provide a comfortable microclimate within the open spaces.
- O.06 Provide safe, at-grade vehicle access across pedestrian areas to the existing and proposed buildings.
- O.07 Engage with Council regarding the open space design on the Western side of St John's Anglican Cathedral prior to lodgement of the Development Application.

Controls

- C.01 Council approval of an agreed detailed design brief and public domain design must be achieved before submission of a Development Application. The Applicant is to liaise with Council at 50% and 90% completion of the public domain design prior to lodgement of the Development Application.
- C.02 The set-out of public domain and new built form at ground level shall be consistent with Figure 9.10.21.8. The new St John's public domain shall be framed by new buildings set back 20 metres from the centreline of St John's Anglican Cathedral and Parramatta Square.



Figure 9.10.21.8 – Public domain set-out plan for Option B

- C.03 Pedestrian access through the open space between Church Street and Hunter Street shall be open to the public 24/7, where possible, whilst providing for the requirements of St John's Anglican Cathedral.
- C.04 Tree planting shall be provided within the public domain that is appropriate to its role, respectful of sight lines including from Hunter Street facing St John's Anglican Cathedral and at a scale that is appropriate to a setting for the St John's Anglican Cathedral. Trees shall be planted at natural (pre new development maximum) ground level, not in raised planters. The size of trees shall be maximized, within the considerations otherwise outlined in this control.
- C.05 A minimum soil depth of 1 metre (excluding structural, drainage and mulch layers) above any basement structure shall be provided for all trees, in contiguous planting pits. Minimum soil volumes for trees on podiums over basements are to be provided according to the [Apartment Design Guide](#).

- C.06 Spaces for public seating shall be provided in a range of locations and to suit different users.
- C.07 Designs shall demonstrate the ability to accommodate a range of uses and activities including servicing requirements in the new public domain, including Parish of Parramatta events such as weddings and funerals and public events.

9.10.21.9 BUILT FORM

This Section of this DCP must be read in conjunction with:

- Section 9.3 – Built Form
- Clause 7.3 Floor space ratio, Clause 7.7 Sun access, Clause 7.23 End of journey facilities, and Clause 7.10 Active frontages in *Parramatta LEP 2023*.

Where there is an inconsistency between the built form controls and objectives in this Section and other Sections of this DCP, this Section prevails.

Objectives

- O.01 Ensure built form outcomes respond to the heritage significant of the site.
- O.02 Ensure built form outcomes that respond to the human scale around St John's Anglican Cathedral, the associated public domain, other heritage items, existing buildings and any proposed street walls.
- O.03 Ensure that street walls of new buildings frame the public domain through appropriate design, scale, and materiality to reflect the primacy of St John's Anglican Cathedral within the overall site.
- O.04 Respond to view corridors including those towards St John's Anglican Cathedral along Church Street, Parramatta Square and Hunter Street.
- O.05 Provide appropriate solar access to the public domain compliant with *Parramatta LEP 2023*.
- O.06 The built form is to provide for flexible and efficient commercial floorplates, whilst satisfying the heritage objectives of this DCP.
- O.07 Provide appropriate building separation to neighbouring sites.
- O.08 Provide weather and wind protection to the open spaces.
- O.09 Ensure architectural responses make a high-quality contribution to the setting and urban design of the area consistent with Council's design excellence policies.
- O.10 Ensure built form outcomes respond to any adjacent buildings or likely future envelopes on neighbouring sites to enable informed consideration of suitable setbacks, built form, access and public domain outcomes as well as amenity impacts.
- O.11 Provide a tall, slender tower on the Northern development site by requiring a splayed edge on the north-eastern Macquarie Street/Centenary Square corner of the tower to reduce the mass and presence of the tower on the civic spaces and open up views across the podium to the street and sky.

Controls

- C.01 Development Applications for new buildings within the St John's Anglican Cathedral complex site must comply with the controls in Section 9.3 – Built Form unless adjusted by the controls below.
- C.02 Street wall or podium interfaces of new development must comply with the following:
- a) Street wall heights to the public domain areas in front of St John's Anglican Cathedral should be in the range of 14-16m in height. The exact height of street walls is to be underpinned by detailed heritage, urban design, and architectural analysis.
 - b) DCP controls in Section 9.3 – Built Form must be applied to determine the outcomes for the Macquarie Street of the podium at the Northern development site, including analysis requirements found in Section 9.4.4 – The Street Wall.
 - c) Resolution of the eastern podium interface at the Northern development site is subject to Section 9.10.21.7 – Heritage of this DCP.
- C.03 The southern and western setback of the Northern development site tower must be a minimum of 6 metres from the podium edge.
- C.04 The eastern setback of the Northern development site tower must not encroach the Church Street upper-level setback line in *Parramatta LEP 2023*.
- C.05 The eastern setback of the Northern development site tower must ensure compliance with the solar access requirement for Parramatta Square set out in Clause 7.7 Sun access of *Parramatta LEP 2023*.
- C.06 The design of basement entry and exit points including any ramps to access lower levels must be contained within the building envelope where possible. No dive structures are permitted within Council owned land and within the open space areas around the Cathedral.
- C.07 If site amalgamation of 41, 43 and 45 Hunter Street can not be achieved, additional massing up to one (1) storey above the specified street wall may be considered for the Southern development site where amenity and heritage impacts can be satisfied and the additional storey is setback a minimum 6 metres from Hunter Street, and the eastern, southern and western setbacks are established through detailed urban design and architectural analysis taking into consideration potential development at 41-43 Hunter Street and the surrounding heritage context.
- Any upper-level addition above the specified street wall should apply construction methods and materiality which reinforce a lightweight and recessive appearance to the architecture above the street wall.
- C.08 The height and design of the street wall/podium at the base of both the northern and southern development sites must respond to the varying interface conditions (street, squares, heritage, and open space). For the Northern development site, development above the podium shall not encroach the PSQ SAP Angle at 2pm mid-winter solstice line shown in Figure 9.10.21.9 to ensure a well-proportioned commercial tower that is tall and slender allowing views across the podium to the surrounding streets and sky from Centenary Square.



Figure 9.10.21.9 – Built Form set-out plan for Option B

CONTROLS THAT APPLY TO OPTION A AND OPTION B

9.10.21.10 VEHICLE ACCESS, PARKING AND SERVICING

This Section of this DCP must be read in conjunction with:

- Section 9.9 – Vehicular Access, Parking and Servicing
- Part 6 – Traffic and Transport
- Division 4 Car parking in *Parramatta LEP 2023*

Where there is an inconsistency between the vehicular access, parking and servicing controls and objectives in this Section of this DCP and other Parts of this DCP, this Section prevails.

Before lodging a Development Application, early consultation with Transport for NSW and Council is encouraged to formulate an agreed access point for ingress and egress to the subject site.

Objectives

- O.01 Minimise the impact of basement facilities on heritage structures and minimise the size and quantity of vehicular access points and driveway crossovers on streetscape amenity, pedestrian safety and the quality of the public domain to be delivered on site.

- O.02 Ensure vehicular access points, driveway crossovers and drive points to basements do not detract the heritage value of the St John's Anglican Cathedral complex.
- O.03 Minimise the vehicle and service crossings to reinforce a high-quality public domain along Macquarie Street, Hunter Street, and the broader St John's Anglican Cathedral complex.
- O.04 Minimise the impact of vehicular servicing and loading activities on the surrounding street network.

Controls

- C.01 The preferred parking/service access for the St John's Anglican Cathedral complex is to be designed in consultation with Transport for NSW to ensure the safe and efficient operation of the Parramatta Light Rail. Interface between new development and the Parramatta Light Rail Corridor is to be designed in consultation with Council and Transport for NSW to ensure safety for pedestrians, accessibility and visual amenity.
- C.02 Where a vehicular driveway to the site is permitted from Macquarie Street, the driveway should be located nearest to the Western site boundary. The vehicular driveway should not interfere with traffic signals and high pedestrian activity occurring nearby in Church Street and Centenary Square. The vehicular driveway should be a minimum of 10 metres from the perpendicular of any intersection of any two streets.
- C.03 In the case that a connected basement cannot be accommodated on the site, access for servicing, waste and loading vehicles for the Southern development is to be provided from the new Southern laneway to the rear of the properties. Vehicle access for residents is to be provided from Hunter Street.
- C.04 A 6-metre-wide access shall be provided along the southern site boundary of the 45 Hunter Street property, with the intent of providing future alternative vehicular access to the Queensland Arcade site via Marsden Street
- C.05 The access to be delivered along the southern site boundary can be clear to sky or within a building overhang / tunnel. The access should allow for a minimum height of 6 metres to ensure access for servicing, waste and loading vehicles.
- C.06 In the case that vehicular access is required from Hunter Street to access either the northern or southern buildings, it should be located on that part of the site furthest from St John's Anglican Cathedral and should not interfere with this heritage item.
- C.07 Vehicular driveways located hard against the property boundary are acceptable, provided pedestrian sightlines are consistent with the relevant Australian Standard.
- C.08 For any development with a residential component, ramping to a basement will need to comply with the 4.5 metre clearance height to accommodate for waste vehicles. Ramping to a basement that is solely used for residential vehicles (no waste vehicles) will need to comply with the minimum 2.1 metre clearance height.
- C.09 Ramping to a basement will be subject to flooding requirements.
- C.10 Basement vehicular parking is to be provided on site to minimise the visual impact of car parking as viewed from the public domain and enhance pedestrian safety at ground level.

- C.11 Vehicular parking should not be provided at ground level. If on grade vehicular access and temporary parking is required for weddings and funerals, it should only be for access to the Cathedral entrances and should have minimal visual impact.
- C.12 In the case where the eastern end of Hunter Street is incorporated in the development site, the road width and cul-de-sac at the end of Hunter Street is to be designed to accommodate the largest vehicle that is expected to access this street (e.g. garbage truck or loading vehicle) and this is to be demonstrated using swept path plans and templates from Austroads Guidelines. Standard road surfaces and kerb and gutter is to be provided in accordance with Council's standards and specifications.
- C.13 Car parking rates provided on site must comply with the rates outlined in the *Parramatta LEP 2023*.
- C.14 All vehicular servicing and loading activities shall be accommodated on-site.

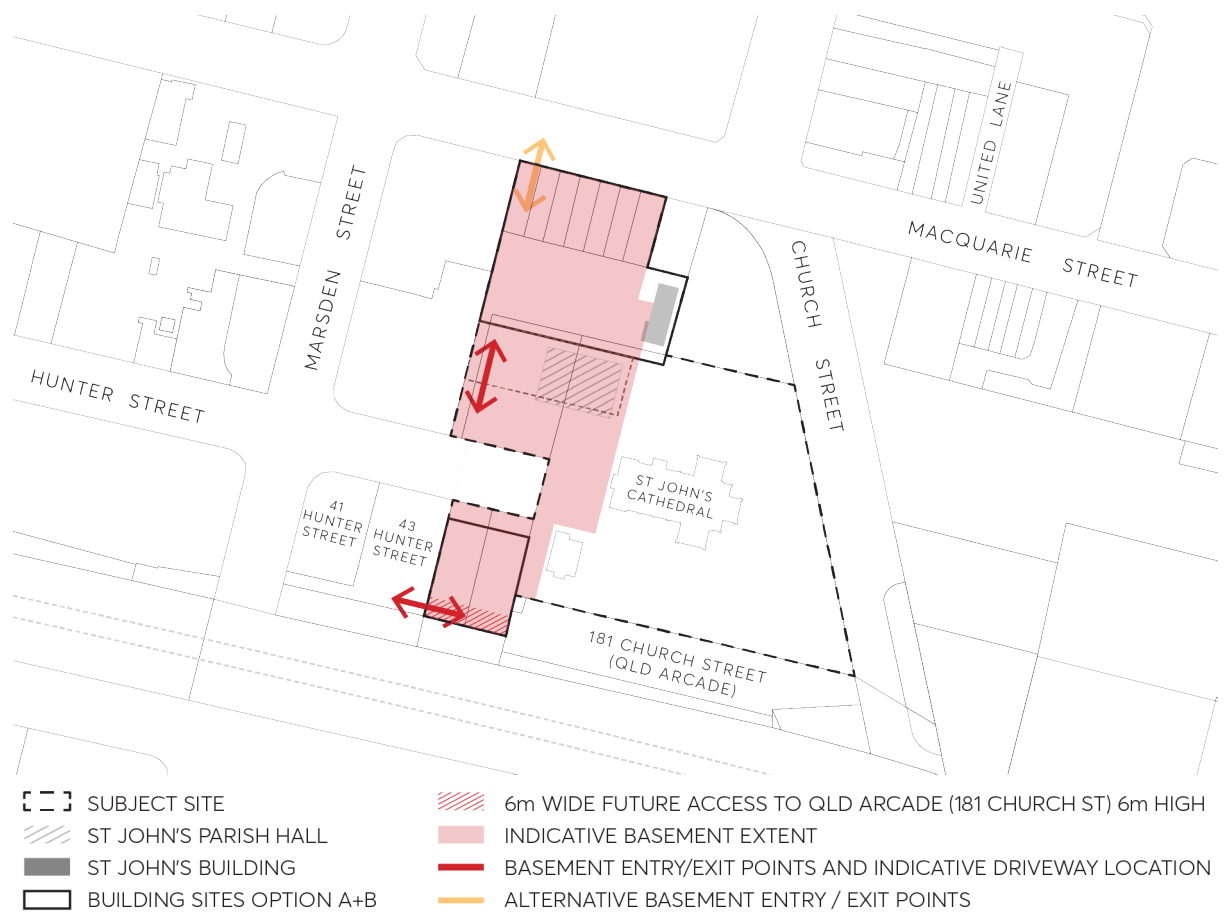

Figure 9.10.21.10 – Vehicular access

9.10.21.11 FLOOD RISK AND RAINWATER MANAGEMENT

This Section of this DCP must be read in conjunction with (but not limited to):

- Section 5.1.1 – Flooding
- Section 9.3.5.2 – Flood Affected Sites

- Section 9.7 – Flood Risk Management
- Clause 7.11 Floodplain risk management of *Parramatta LEP 2023*

Where there is an inconsistency between the flooding and rainwater management objectives and the controls in this Section of this DCP and other Parts of this DCP, this Section prevails.

Proponents are also encouraged to refer to Council's *Floodplain Risk Management Policy and Plan* which have been created as required by the NSW Flood Policy and NSW Floodplain Development Manual.

Note: A word or expression used in this Section of this DCP has the same meaning as it has in the Floodplain Development Manual (ISBN 0 7347 5476 0), published in 2005 by the NSW Government, unless it is otherwise defined in Parramatta DCP 2023.

Objectives

- O.01 Appropriately address the level of flood affectation on the site and manage flood risks and stormwater flows on the site and immediate surrounds.
- O.02 Achieve sustainable environmental management of rainwater.
- O.03 Integrate flood planning and risk management with urban design and active street frontages to minimise impacts associated with flood inundation.
- O.04 Deep soil and permeability of surfaces is to be provided to minimise rainwater runoff.

Controls

- C.01 The interaction between flooding and built form for redevelopment of the St John's Anglican Cathedral complex site should be modelled, planned and designed consistent with Clause 7.11 Floodplain risk management of *Parramatta LEP 2023* and controls in Section 9.7 – Flood Risk Management of this DCP.
- C.02 Future redevelopment of the St John's Anglican Cathedral complex site as a whole and for the individual buildings should be designed to respond to the flooding environment both from Parramatta River and from local overland flow.
- C.03 The Flood Planning Level is currently defined as the higher of the 1% Annual Exceedance Probability (AEP) riverine flood level plus 0.5m freeboard or the 1% AEP overland flow flood level plus 0.5m freeboard. Council reserves the right to increase the Flood Planning Level to account for Climate Change. Flood Planning Levels may vary around the precinct according to adjacent flood levels.
- C.04 Parramatta River (riverine) flooding which must be addressed includes 5% AEP, 1% AEP, a Climate Change scenario (1% AEP+ 20% increased rainfall intensity) and the Probable Maximum Flood (PMF). These levels and flood extents may be obtained from Council.
- C.05 Local overland flow flooding which must be addressed includes 5% AEP, 1% AEP and a Climate Change scenario (1% AEP+ 20% increased rainfall intensity) (PMF is not required.) These levels extents and flood properties are to be obtained from the overland flow flood study in consultation with Council.

- C.06 A 2D overland flow study is to be submitted with all future development applications and must be consistent with:
- Council requirements including modelling local overland flow flooding assuming no benefit from the network of piped drainage (100% blockage).
 - the 'Overland Flow Flood Study' prepared for Parramatta Square by BG&E Consultants on behalf of Council and Walker Corporation; and when it becomes available, reference Council's amended Flood Study now in preparation. (**Note:** Council officers will assist in reconciling these studies if necessary).
- C.07 Local stormwater must be managed by providing underground piped reticulation of stormwater to Council and Australian Standards for 5% AEP design storms designed in accordance with Australian Rainfall and Runoff 2019.
- C.08 Built form and public domain designs need to allow for overland flow paths between and around buildings.
- C.09 On site detention is required to:
- be provided and operated for all private land in accordance with the Upper Parramatta River Catchment Trust Handbook Edition 4. Land that is to be public land is exempt from this unless Council advises otherwise.
 - include rainfall on all horizontal surfaces, including roofing and at ground level, and also significant vertical structures subject to wind-driven rain.
- C.10 Rainwater must be captured to the maximum extent possible and used on-site as a substitute water supply to reduce the demand for drinking water, particularly for landscape irrigation. This may be integrated with, or be an alternative to, the OSD system.
- C.11 Deep soil and permeability of surfaces must be maximised to minimise rainwater runoff.
- C.12 Where horizontal evacuation is not feasible, Shelter In Place or vertical evacuation must be provided for all building occupants (residents, workers and visitors) consistent with:
- Clause 7.11 Floodplain risk management of *Parramatta LEP 2023* and,
 - Section 9.7.4 – Flood Warning and Emergency Response Planning of this DCP.
- C.13 Building Management Systems and Plans for the development are required and must include all necessary measures to maintain, test and operate the flood protection devices including flood gates, doors and barriers, flood sensors, flood refuges and Flood Emergency Response Plans (FERPs).
- C.14 Tanked (waterproof) basement construction is required, and groundwater must not be extracted, drained or pumped from the basement surrounds and underfloor into Council's drainage system at any time.
- C.15 Built form and public domain designs need to allow for overland flow paths between and around buildings
- C.16 Water Sensitive Urban Design (WSUD) must be integrated into the overall precinct and individual building designs, particularly as part of the landscape design. Water management and quality treatment must primarily be achieved in the landscape and 'end of pipe' proprietary treatment devices must not be the primary means of achieving water quality targets. WSUD systems must be conceptualised as treatment trains and networks and assessed using MUSIC

software modelling (or equivalent). Water quality targets must be in accordance with this DCP unless otherwise advised by Council.

- C.17 Commercial and retail development within a basement below the Flood Planning Level is, in general, not permitted within a building that occupies land subject to flooding in a PMF event.

9.10.21.12 ENVIRONMENTAL SUSTAINABILITY

This Section of this DCP must be read in conjunction with (but not limited to):

- Section 9.8 – Environmental Sustainability
- Clause 7.25 High performing buildings and Clause 7.24 Dual water systems of *Parramatta LEP 2023*

The controls in Section 9.10.21.12 respond to increasing demands on energy, water and sewerage infrastructure as well as in response to improve sustainable building technologies, and aim to deliver high performing buildings in the City Centre and limit environmental impacts from increased growth and the additional density in the St John's Anglican Cathedral complex.

Where there is an inconsistency between the environmental sustainability objectives and the controls in this Section of this DCP and other Sections of this DCP, this Section prevails.

Objectives

- O.01 Incorporate building services that reduces the demand for energy and water resources.
- O.02 Minimise the use of natural resources through resource recovery and waste avoidance measures.
- O.03 Ensure that buildings are designed to inhibit wind funnelling and that the major public spaces are screened from winter winds and open to cooling summer breezes.
- O.04 Ensure built form provides a comfortable pedestrian environment and public domain.
- O.05 Residential flat buildings are to minimise reliance on mechanical ventilation and reliance on artificial lighting by implementing passive design measures.
- O.06 Use landscape design to modify summer and winter climatic conditions and improve amenity for people using the open space.
- O.07 Maximise energy efficiency in building design, orientation, and siting.

Controls

- C.01 Development Applications for new buildings within the St John's Anglican Cathedral complex site must comply with:
- Section 9.8 – Environmental Sustainability
 - Clause 7.25 High performing buildings and Clause 7.24 Dual water systems of *Parramatta LEP 2023*

PARRAMATTA CITY CENTRE – AUTO ALLEY (WEST)

CONTENTS

9B.1	BUILDING FORM.....	391
9B.1.1	MINIMUM BUILDING STREET FRONTAGE.....	391
9B.1.2	BUILDING TO STREET ALIGNMENT AND STREET SETBACKS	392
9B.1.3	STREET AND RIVER FRORNTAGE HEIGHTS AND UPPER LEVEL SETBACKS.....	393
9B.1.4	BUILDING DEPTH AND BULK.....	395
9B.1.5	BULIDING SEPARATION	396
9B.1.6	BUILDING FORM AND WIND MITIGATION.....	396
9B.1.7	BUILDING EXTERIORS.....	397
9B.2	MIXED USE BUILDINGS.....	399
9B.3	PUBLIC DOMAIN AND PEDESTRIAN AMENITY	400
9B.3.1	ACTIVE FRONTAGES	400
9B.4	ACCESS AND PARKING	402
9B.4.1	VEHICLE FOOTPATH CROSSINGS.....	402
9B.4.2	PEDESTRIAN ACCESS AND MOBILITY	403
9B.4.3	VEHICULAR DRIVEWAYS AND MANOEUVRING AREAS	404
9B.4.4	ON-SITE PARKING	405
9B.4.5	ABOVE GROUND CAR PARKING.....	407
9B.4.6	LEASING OF EXISTING SURPLUS COMMERCIAL CAR PARKING SPACES.....	408
9B.5	ENVIRONMENTAL MANAGEMENT	410
9B.5.1	LANDSCAPE DESIGN.....	410
9B.5.2	PLANTING ON STRUCTURES.....	411
9B.5.3	GREEN ROOFS.....	412
9B.5.4	ENERGY AND WATER EFFICIENT DESIGN.....	413
9B.5.5	RECYCLED WATER.....	413

9B PARRAMATTA CITY CENTRE – AUTO ALLEY WEST

The controls in this Part apply to land zoned E3 Productivity Support within the Parramatta City Centre as shown in Figure 9B.1.

The specific objectives and controls for this precinct detailed below are to be applied in conjunction with the general objectives and controls in Part 2, 3, 5, 6 and 7 of this DCP. Where there is any inconsistency with any other part of the DCP, the objectives and controls of this section will prevail.

The broad objectives for the Auto Alley (West Area) are:

- O.01 To support the commercial core with surrounding mixed use development that reinforces and complements the centre’s core employment role.
- O.02 To ensure high-quality design of buildings.
- O.03 To provide for the conservation and interpretation of Parramatta’s heritage.
- O.04 To improve the natural environment.



Figure 9B.1 – Land Application Map – Auto Alley (West)

9B.1 BUILDING FORM

The provisions in this Section are intended to encourage high-quality design. New development should contribute to an attractive public domain and produce a desirable setting for its intended uses.

Objectives

The following general objectives apply to this Section:

- O.01 To establish appropriate scale, dimensions, form and separation of buildings.
- O.02 Achieve active street frontages with good physical and visual connections between buildings and the street.
- O.03 Define the public street so that it provides spaces that are legible, safe, comfortable, functional and attractive.
- O.04 Ensure building depth, bulk and separation allows for view sharing and protects amenity, daylight penetration and privacy between adjoining developments.
- O.05 Achieve an articulation and finish of building exteriors that contributes to a high-quality and sustainable urban environment.

9B.1.1 MINIMUM BUILDING STREET FRONTAGE

Objectives

- O.01 To ensure that visually, buildings have an appropriate overall horizontal proportion compared to their vertical proportions.
- O.02 To ensure that vehicular access is reasonably spaced and separated along roads and lanes.
- O.03 To provide appropriate dimensions for the design of car parking levels.

Controls

- C.01 Development parcels are required to have at least one street frontage of 20m or more.
- C.02 Exceptions to the minimum building street frontage will be considered:
 - if Council is satisfied that due to the physical constraints of the site or adjoining sites it is not possible for the building to be erected with at least one street frontage of 20m or more, and
 - the development meets the objectives of this clause.

9B.1.2 BUILDING TO STREET ALIGNMENT AND STREET SETBACKS

Street setbacks and building alignments establish the front building line and reinforce the spatial definition of streets. Consistent building lines within streets and blocks are desirable and generally buildings should be built to the street alignment to enhance pedestrian amenity and activity at street level. Setbacks should also respond to public spaces, the river foreshore, enhance heritage settings and may also provide for landscape areas and growing areas for street trees.

Objectives

- O.01 To provide street edges which reinforce, improve or support the hierarchy and character of specific city streets and lanes.
- O.02 To ensure there are consistent street frontages with buildings having common alignments.
- O.03 To present appropriate design responses to nearby development that complement the streetscape.
- O.04 To create a clear transition between public and private space.
- O.05 To assist in achieving visual privacy to apartments from the street.
- O.06 To allow for street landscape character, where appropriate.

Controls

- C.01 Comply with the street building alignment and front setbacks specified in Figure 9B.1.2.1.
- C.02 Building alignments and setbacks should also respond to important elements of the nearby context including public spaces and heritage buildings, monuments and landscape elements, in order to complement the streetscape. In some places, this may require greater building setbacks than those specified in Figure 9B.1.2.1.
- C.03 Where the building alignment is set back from the street alignment, balconies are to be generally within the building envelope and may project up to 600mm into front building setbacks.
- C.04 Minor projections into front building lines and setbacks for sun shading devices, entry awnings and cornices are permissible. (See also Section 9B.1.7 – Building Exteriors).



Figure 9B.1.2.1 – Building Alignment and Front Setbacks (to streets)

9B.1.3 STREET AND RIVER FRONTAGE HEIGHTS AND UPPER LEVEL SETBACKS

Street frontage heights refer to the height of the building that is built to the street alignment and therefore directly addresses the public street, lane or the river. The street section figures contained in this Section of this DCP specify the required street and river frontage heights and the required upper level setbacks above.

The street frontage height is the vertical distance measured at the centre of the street frontage from the average of the street levels at each end of the frontage to the parapet level of the frontage. The parapet level is the horizontal plane in which at least two thirds of the length of the top of the façade is situated.

Objectives

- O.01 To strengthen the urban form of the City Centre Deferred Area with consistent street wall heights.
- O.02 To achieve comfortable street and riverfront environments for pedestrians in terms of daylight, scale, sense of enclosure and wind mitigation as well as a healthy environment for street trees.
- O.03 To enhance the distinctive character of streets within Parramatta City Centre Deferred Area.

Controls

- C.01 Buildings must comply with the relevant street and river frontage heights and upper level setbacks as shown in Figures 9B.1.1 and 9B.1.2. Podium heights must not exceed both the number of storeys and the height in metres.
- C.02 The street frontage height that applies to a shared lane is the same as that of the closest street frontage height the lane connects to. In instances where the lane connects to two or more streets, the higher street frontage height applies (to a maximum of 26 metres).
- C.03 Corner sites may be built with no upper level setback to the secondary street edge for the first 45 metres within the same site/amalgamation. This helps to articulate corners, generate feasible floor plates as well as allow corner towers to engage directly with the street and footpath. Refer to Figure 9B.1.6.
- C.04 The following take precedence in determining the primary and secondary street frontages:
 - Streets running E-W
 - Streets running N-S



Figure 9B.1.1 – Street / River Frontage Heights – Parramatta City Centre Deferred Area

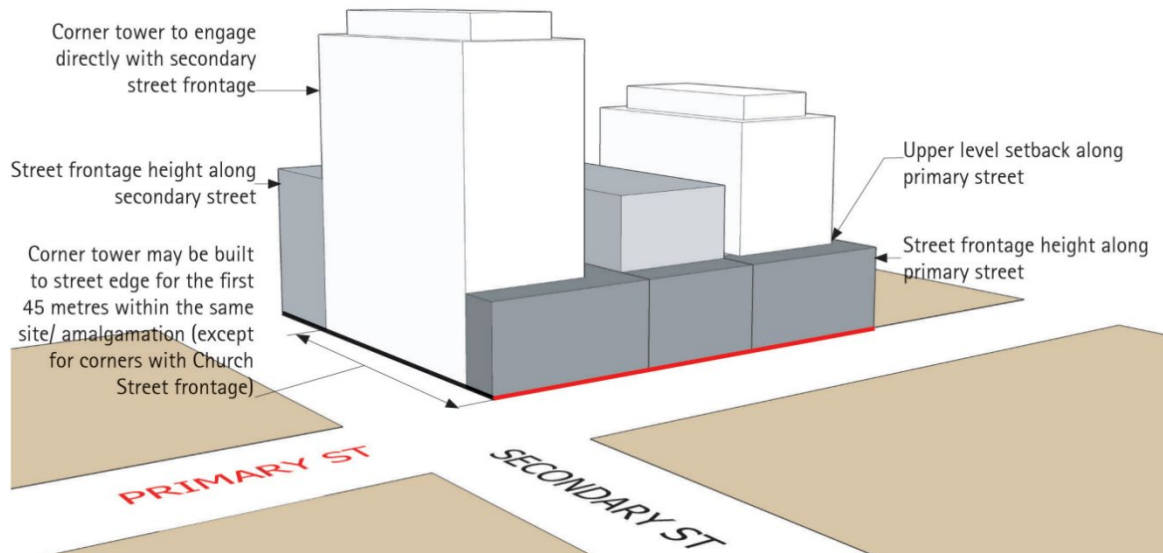

Figure 9B.1.2 – Indicative Corner Condition with different Street Frontage Heights

9B.1.4 BUILDING DEPTH AND BULK

Controlling building depth and bulk allows for good internal amenity, access to natural light and ventilation and mitigates potential adverse effects that tall and bulky buildings may have on the public domain.

Building depth is typically related to building use and the need for access to light and ventilation to building interiors and the comfort and amenity required for inhabitants.

Objectives

- O.01 To promote the design and development of sustainable buildings.
- O.02 To achieve living and working environments with good internal amenity and minimise the need for artificial heating, cooling, and lighting.
- O.03 To provide viable and useable commercial floor space.
- O.04 To achieve usable and pleasant streets and public domain at ground level by controlling the size of upper level of buildings.
- O.05 To achieve a city skyline sympathetic to the topography and context.
- O.06 To allow for view sharing and view corridors.
- O.07 To reduce the apparent bulk and scale of buildings by breaking up expanses of building wall with modulation of form.

Controls

- C.01 All points on an office floor should be no more than 12m from a source of daylight (e.g. window, atria, or light wells).

9B.1.5 BULIDING SEPARATION

Objectives

- O.01 To ensure an appropriate level of amenity for building occupants in terms of daylight, outlook, view sharing, ventilation, wind mitigation, and privacy.
- O.02 To achieve usable and pleasant streets, lanes, parks, and public spaces in terms of wind mitigation, daylight, and solar access.

Controls

- C.01 Where permissible, side and rear boundaries are to be built to zero metres at lower levels of buildings.
- C.02 Where a rear setback/courtyard is proposed at ground level, a minimum dimension of 6 metres must be provided. Ground level setbacks must have daylight and amenity. Deep soil zones/podium landscape should be co-located to the rear to create pockets of landscape/mature trees within the block.
- C.03 Notwithstanding side setback controls, the podium should be built to the side boundaries (0 metres setback) where fronting the street.
- C.04 If the specified setback distances cannot be achieved when an existing building is being refurbished or converted to another use, appropriate visual privacy levels are to be achieved through other means.
- C.05 The building separation distances between buildings on the same site are not to be less than those required between buildings on adjoining sites, unless it can be demonstrated that reducing the separation distances provides adequate privacy and solar access to the buildings concerned.

9B.1.6 BUILDING FORM AND WIND MITIGATION

Objectives

- O.01 To ensure that building form enables the achievement of nominated wind standards to maintain safe and comfortable conditions in the City Centre deferred area streets and lanes.

Controls

- C.01 To ensure public safety and comfort the following maximum wind criteria are to be met by new buildings:
 - i) 10 metres/second in retail streets
 - ii) 13 metres/second along major pedestrian streets, parks and public places
 - iii) 16 metres/second in all other streets

C.01 Site design for tall buildings (towers) should:

- i) Set tower buildings back from lower structures built at the street frontage.
- ii) Protect pedestrians from strong wind downdrafts at the base of the tower.
- iii) Ensure that tower buildings are well spaced from each other to allow breezes to penetrate City Centre Deferred Area.
- iv) Consider the shape, location and height of buildings to satisfy wind criteria for public safety and comfort at ground level.
- v) Ensure useability of open terraces and balconies.

9B.1.7 BUILDING EXTERIORS

Parramatta's cityscape and public domain is defined by its buildings, streets and public places. The maintenance and improvement of the public domain is dependent on a high-quality approach to the design of new development including the articulation and finish of building exteriors.

Objectives

To ensure that buildings:

- O.01 Contribute positively to the streetscape and public domain by means of high-quality architecture and selection of appropriate materials and finishes.
- O.02 Provide richness of detail and architectural interest especially at visually prominent parts of buildings such as lower levels and roof tops.
- O.03 Present appropriate design responses to nearby development that complement the streetscape.
- O.04 Clearly define the adjoining streets, street corners and public spaces and avoid ambiguous external spaces with poor pedestrian amenity and security.
- O.05 Maintain a pedestrian scale in the articulation and detailing of the lower levels of the building.
- O.06 Restrict the reflection of sunlight from buildings to surrounding areas and buildings.

Controls

- C.01 Adjoining buildings (particularly heritage buildings) are to be considered in the design of new buildings in terms of:
 - datum of main façade and roof elements,
 - appropriate materials and finishes selection, and
 - facade proportions including horizontal or vertical emphasis.
- C.02 Balconies and terraces should be provided, particularly where buildings overlook parks and on low rise parts of buildings. Gardens on the top of setback areas of buildings are encouraged.
- C.03 Articulate façades so that they address the street and add visual interest.

- C.04 External walls should be clad with high-quality and durable materials and finishes.
- C.05 Finishes with high maintenance costs, those susceptible to degradation or corrosion that result in unacceptable amenity impacts, such as reflective glass, are to be avoided.
- C.06 To assist articulation and visual interest, avoid large expanses of any single material.
- C.07 Limit opaque or blank walls for ground floor uses to 30% of the building street frontage.
- C.08 Maximise glazing for ground floor retail uses, but break glazing into sections to avoid large expanses of glass.
- C.09 A materials sample board and schedule is required to be submitted with applications for development over \$1 million or for that part of any development built to the street edge.
- C.10 Minor projections up to 450mm from building walls in accordance with those permitted by the Building Code of Australia may extend into the public space providing it does not fall within the definition of gross floor area and there is a public benefit, such as:
- expressed cornice lines that assist in enhancing the streetscape, and
 - projections such as entry canopies that add visual interest and amenity.
- C.11 The design of roof plant rooms and lift overruns is to be integrated into the overall architecture of the building.
- C.12 New buildings and facades should not result in glare that causes discomfort or threatens safety of pedestrians or drivers.
- C.13 Subject to the extent and nature of glazing and reflective materials used, a Reflectivity Report that analyses potential solar glare from the proposed development on pedestrians or motorists may be required.

9B.2 MIXED USE BUILDINGS

Auto Alley (West) buildings provide for a variety of uses and activities that reinforce the character and function of the Auto Alley (West) and create activity and lively streets. In mixed use buildings, different uses are contained within the same building and are best located to a pattern and layout suitable to the mix of uses.

Objectives

- O.01 To create active and lively streets with enhanced public safety by increasing activity in the public domain.
- O.02 To minimise potential conflicts and achieve compatibility between different uses.
- O.03 To create legible and safe access and circulation in mixed use buildings.
- O.04 To ensure that buildings address the public domain and the street.

Controls

- C.01 Specialised retail and business activity should be provided at ground level to support street activation.
- C.02 Ground floor of all mixed-use buildings are to have a minimum floor to ceiling height of 3.6m in order to provide for flexibility of future use. Above ground level, minimum floor to ceiling heights are to be a minimum of 2.7 metres.
- C.03 Provide security access controls to all entrances into private areas, including car parks and internal courtyards.
- C.04 Front buildings onto major streets with active uses.
- C.05 Avoid the use of blank building walls at the ground level at street or lane frontages.
- C.06 Facilities for servicing the building, sub-stations, waste collection and the like are to be integrated as part of the building design to minimise the impact on active street frontages.

9B.3 PUBLIC DOMAIN AND PEDESTRIAN AMENITY

The public domain includes the publicly accessible shared spaces, including streets, lanes, squares and parks. The public domain is also affected by the private domain - the design quality of adjoining buildings, overshadowing, the design and location of building entrances, setbacks and signage.

The pedestrian network is a key aspect of the public domain. The pedestrian amenity provisions in this Section are intended to achieve a high-quality of urban design, pedestrian comfort and safety in the public spaces of the Auto Alley (West).

Council has adopted the [Parramatta Public Domain Guidelines](#) which are available on Council's web site. These guidelines need to be referred to for new developments in the Auto Alley (West) and require the preparation for approval of an Alignments Plan and a Public Domain Plan.

Council's tree mapping in its [Parramatta Public Domain Guidelines](#) has a Street Tree Plan, available on request, which should be consulted when preparing a public domain plan. Species selection for Auto Alley (West) developments should be appropriate for proposed building heights and Auto Alley (West) micro-climates to mitigate the urban heat island effect.

9B.3.1 ACTIVE FRONTAGES

Active frontages provide a visual connection between the public domain and the interiors of buildings. This can be achieved by the design and level of building entries from streets, lanes and other public spaces, window displays, façade modulation and glazing and location of uses such as cafes, restaurants, reception areas and customer service counters at visible frontages to the public domain.

Active frontage uses are defined as one, or a combination of the following at street level:

- Entrance to specialised retail.
- Glazed entries to lobbies.
- Café or restaurant if accompanied by an entry from the street.
- Active office uses, such as reception, if visible from the street.
- Public building if accompanied by an entry.

Objectives

- O.01 To promote pedestrian activity and safety in the public domain.
- O.02 To maximise active street and lane fronts in the Auto Alley (West).
- O.03 To define areas where active frontages are required.

Controls

Active Frontages

- C.01 Active frontages are required throughout the Auto Alley (West) for a minimum of 50% of each building front.
- C.02 Active ground floor uses are to be at the same level as the footpath and be accessible directly from the street. (Refer to Council's [Parramatta Public Domain Guidelines](#) and the requirement for an Alignments Plan).
- C.03 Provide multiple entrances for large developments including an entrance on each street frontage.
- C.04 Security grilles detract from an active street front, but where they are essential, must be fitted only internally within the shopfront and set back from the line of enclosure. Such grilles are to be fully retractable and at least 50% transparent in their closed state.
- C.05 Extend active frontages above ground floor level with uses and building design, which provide transparency, and visual contact with the public domain.

9B.4 ACCESS AND PARKING

9B.4.1 VEHICLE FOOTPATH CROSSINGS

The design and location of vehicle access to developments should minimise both conflicts between pedestrians and vehicles on footpaths, particularly along pedestrian priority places and visual intrusion and disruption of streetscape continuity.

Objectives

- O.01 To make vehicle access to buildings more compatible with pedestrian movements and the public domain.
- O.02 To ensure vehicle entry points are integrated into building design and contribute to high-quality architecture and streetscapes.

Controls

Location of Vehicle Access

- C.01 One vehicle access point only (including the access for service vehicles and parking for non-residential uses within mixed use developments) will be generally permitted.
- C.02 Where practicable, vehicle access is to be from lanes and minor streets rather than primary street fronts or streets with major pedestrian activity.
- C.03 Where practicable, adjoining buildings are to share or amalgamate vehicle access points. Internal on-site signal equipment is to be used to allow shared access. Where appropriate, new buildings should provide vehicle access points so that they are capable of shared access at a later date.
- C.04 Vehicle access may not be required or may be denied to some heritage buildings.

Design of Vehicle Access

- C.05 Vehicle access ramps parallel to the street frontage will not be permitted.
- C.06 Doors to vehicle access points are to be fitted behind the building façade and to be of materials that integrate with the design of the building and contribute to a positive public domain.
- C.07 Vehicle entries are to have high-quality finishes to walls and ceilings as well as high standard detailing. No service ducts or pipes are to be visible from the street.

Porte Cocheres

- C.08 Porte cocheres disrupt pedestrian movement and do not contribute to active street frontage. They may only be permitted in exceptional circumstances for hotels and major tourist venues subject to high-quality urban design, streetscape, heritage and pedestrian amenity considerations.
- C.09 If justified, porte cocheres should preferably be internal to the building with one combined vehicle entry and exit point, or one entry and one exit point on two different street fronts of the development.

- C.10 In exceptional circumstances for buildings with one street frontage only, an indented porte cochere with separate entry and exit points across the footpath may be permitted, as long as:
- it is constructed entirely at the footpath level,
 - provides active street frontage uses in addition to any hotel entry or lobby at its perimeter,
 - is of high-quality design and finish, and
 - provides for safe and clear pedestrian movement along the street.

9B.4.2 PEDESTRIAN ACCESS AND MOBILITY

Objectives

- O.01 To ensure that all people who live, work, or visit the city are able to access and use all spaces, services and facilities through the creation of a barrier free environment in all public spaces, premises and associated spaces.
- O.02 To provide a safe and easy access to buildings to enable better use and enjoyment by people regardless of age and physical condition, whilst also contributing to the vitality and vibrancy of the public domain.

Controls

- C.01 Main building entry points should be clearly visible from primary street frontages and enhanced as appropriate with awnings, building signage or high-quality architectural features that improve clarity of building address and contribute to visitor and occupant amenity.
- C.02 Access to public areas of buildings and dwellings should be direct and without unnecessary barriers. Avoid obstructions, which cause difficulties including:
- uneven and slippery surfaces;
 - steep stairs and ramps;
 - narrow doorways, paths and corridors; and
 - devices such as door handles which require two hands to operate.
- C.03 The design of facilities (including car parking requirements) for disabled persons must comply with the relevant Australian Standard (AS 1428.1 and AS1438.2, or as amended) and the *Disability Discrimination Act 1992* (as amended).
- C.04 The development must provide at least one main pedestrian entrance with convenient barrier free access in all developments to at least the ground floor.
- C.05 The development must provide continuous paths of travel from all public roads and spaces as well as unimpeded internal access.
- C.06 Pedestrian access ways, entry paths and lobbies must use durable materials commensurate with the standard of the adjoining public domain (street) with appropriate slip resistant materials, tactile surfaces and contrasting colours.

9B.4.3 VEHICULAR DRIVEWAYS AND MANOEUVRING AREAS

Objectives

- O.01 To minimise the impact of vehicle access points and driveway crossovers on streetscape amenity, pedestrian safety and the quality of the public domain by:
- designing vehicle access to required safety and traffic management standards,
 - integrating vehicle access with site planning, streetscape requirements, traffic patterns, and
 - minimising potential conflict with pedestrians.
- O.02 To minimise the size and quantity of vehicle and service crossings to retain streetscape continuity and reinforce a high-quality public domain.

Controls

- C.01 Driveways should be:
- Provided from lanes and secondary streets rather than the primary street, wherever practical.
 - Located taking into account any services within the road reserve, such as power poles, drainage inlet pits and existing or proposed street trees.
 - Located a minimum of 10 metres from the perpendicular of any intersection of any two roads.
 - If adjacent to a residential development, setback a minimum of 1.5m from the relevant side property boundary.
- C.02 Vehicle access is to be designed to:
- minimise the visual impact on the street, site layout and the building façade design, and
 - if located off a primary street frontage, integrated into the building design.
- C.03 All vehicles must be able to enter and leave the site in a forward direction without the need to make more than a three point turn.
- C.04 Separate and clearly differentiate pedestrian and vehicle access.
- C.05 Locate vehicle access a minimum of 3 metres from pedestrian entrances.
- C.06 Minimise the size and quantity and visual intrusion of vehicle access points.
- C.07 Vehicular access may not ramp along boundary alignments edging the public domain, streets, lanes parks, water frontages and the like.
- C.08 Design of driveway crossings must be in accordance with Council's standard Vehicle Entrance Designs, with any works within the footpath and road reserve subject to a Section 138 *Roads Act* approval.
- C.09 Driveway widths must comply with the relevant Australian Standards.
- C.10 Car space dimensions must comply with the relevant Australian Standards.

- C.11 Driveway grades, vehicular ramp width/grades and passing bays and sight distance for driveways must be in accordance with the relevant Australian Standard, (AS 2890.1).
- C.12 Vehicular ramps less than 20 metres long within developments and parking stations must have a maximum grade of 1 in 5 (20%). Ramp widths must be in accordance with AS 2890.
- C.13 Access ways to underground parking should not be located adjacent to doors of the habitable rooms of any residential development.
- C.14 For residential development, use semi-pervious materials for all uncovered parts of driveways/spaces to provide for some stormwater infiltration.
- C.15 Vehicular access, egress and manoeuvring is to be provided in accordance with the NSW Fire Brigades Code of Practice – Building Construction – NSWFB Vehicle Requirements.
- C.16 Generally, provision must be made for NSW Fire Brigade vehicles to enter and leave the site in a forward direction where:
- NSW Fire Brigade cannot park their vehicles within the road reserve due to the distance of hydrants from the building or restricted vehicular access to hydrants; or
 - the site has an access driveway longer than 15m.

9B.4.4 ON-SITE PARKING

On-site parking includes underground (basement), surface (at-grade) and above ground parking, including parking stations. Underground and semi-underground parking minimises the visual impact of car parks and is an efficient use of the site. Above ground parking may be appropriate for some sites, especially for sites constrained because of flood levels or archaeological conditions. However, above ground car parking will only be accepted if it is of a high design quality and meets the design controls specified in this Section. Car parking rates for the Parramatta City Centre Deferred Area are contained in Clause 7.17 Car Parking of *Parramatta LEP 2023*. These rates are maximums rates and are not to be exceeded.

9B.4.4.1 CAR PARKING RATES

Objectives

- O.01 To facilitate an appropriate level of on-site parking provision in Auto Alley (West) to cater for a mix of development types.
- O.02 To minimise the visual impact of on-site parking.
- O.03 To provide adequate space for parking and manoeuvring of vehicles (including service vehicles and bicycles).
- O.04 To recognise the complementary use and benefit of public transport and non-motorised modes of transport such as bicycles and walking.

Controls

- C.01 Where car parking is provided in basements, and semi-basements, development which will involve excavation shall incorporate the recommended site management procedures set out in the Parramatta Historical Archaeological Landscape Management Study.
- C.02 Consolidate basement car parking areas under building footprints to maximise the area available for deep soil planting beneath forecourts and courtyards.
- C.03 Maximise the efficiency of car park design with predominantly orthogonal geometry and related to circulation and car space sizes.
- C.04 Design parking structures which minimise reliance on artificial lighting and car exhaust ventilation.
- C.05 Provide 1-2% readily accessible parking spaces, designed and appropriately signed for use by people with disabilities.
- C.06 Provide separate parking for motorcycles for an area equal to 1 car parking space, as a minimum, for every 50 car parking spaces provided, or part thereof. Motor cycle parking does not contribute to the number of parking spaces for the purpose of complying with the maximum number of parking spaces permitted.
- C.07 On-site parking must meet the relevant Australian Standard (AS 2890.1 2004 – Parking facilities, or as amended).
- C.08 Provide marked pedestrian pathways to car parking areas with clear lines of sight and safe lighting especially at night.

Bicycle Parking

- C.09 Make provision for secure bicycle parking in all public car parks and every building with onsite parking, in compliance with Part 6 – Traffic and Transport of this DCP.
- C.10 Bicycle parking in public car parks will achieve safe, easy, and convenient access from the building to public streets.
- C.11 For commercial and retail development providing employment for 20 persons or more, provide adequate change and shower facilities for cyclists. Facilities should be conveniently located close to bike storage areas.

Parking for commercial developments and mixed use developments

- C.12 The impact of any at-grade car parking must be minimised by:
- locating parking on the side or rear of the lot away from the street frontage;
 - provision of fencing or landscaping to screen the view of cars from adjacent streets and buildings; and
 - allowing for safe and direct access to building entry points.
- C.13 Natural ventilation should be provided to underground parking areas where possible, with ventilation grilles and structures;
- integrated into the overall façade and landscape design of the development,
 - not located on the primary street façade, and

- oriented away from windows of habitable rooms and private open spaces areas.

9B.4.5 ABOVE GROUND CAR PARKING

Objectives

- O.01 To provide car parking in an efficient and cost-effective manner.
- O.02 Ensure the manner in which the car parking is provided maintains and improves the amenity, aesthetic quality and liveability of the public domain.
- O.03 Provide car parking in a manner that would make a reduction in the amount and rate of car parking provision possible as the city economy strengthens and alternative modes of transport are developed to serve the city.
- O.04 Design car parking to be energy efficient, well lit, safe, and attractive.

Controls

- C.01 The preferred location of car parking in the Auto Alley (West) is in basements. Above ground car parking may be appropriate for some sites, especially where there are constraints such as flood levels and/or archaeological conditions. Above ground car parking will only be permitted where the car parking:
 - Is of high-quality design and will not have an adverse impact on the visual and acoustic amenity of neighbouring buildings and public domain.
 - Is located behind other active uses including residential, retail and office when the frontage is to a primary street or public domain as indicated on Figure 9B.4.2. Where activation of above ground levels is required, the active use is to wrap around the corner of the building for a minimum of 15m. Refer to Figure 9B.4.3
 - Is screened from the public domain, including all streets and lanes through the use of screening devices, architectural elements and landscaping that is integrated into the design of the building. Cars are not to be visible from the public domain. Car parking luminaires are not to be visible from the public domain. Refer to Figure 9B.4.3.
 - Has an access that will not have an unacceptable impact on streetscape or the public domain in accordance with Figure 9B.4.1.
 - Does not extend higher than the frontage and podium heights permitted on adjoining streets and in the case of different heights the lesser of the two.
 - Is fully enclosed by a suitably designed wall or screen at ground level (on the frontages not required to be sleeved with active uses), with the exception of air supply vents, which should be a minimum of 2.3m above the ground at their lowest point, and designed to ensure the interior of the car park is not visible from the adjoining public domain.
 - Allows for the creation of mid-block connections and laneways as indicated on Figure 9B.4.2.

- Is set back from the rear boundary of lots by a minimum of 6 metres to allow for natural 'make up air supply' to ensure efficient low energy operation.
- New access points to all parking (above and below ground) are to be limited in accordance Figure 9B.4.2. New access points will be permitted from existing lanes or new lanes, which may be created as part of the development.
- If located on a roof top, is not open to the sky or visible from other buildings.
- Has a minimum floor to ceiling height, clear of obstruction, of 2.7 metres above ground level and 3.3m on ground level.

C.02 Car parking areas:

- are to be well lit,
- are to avoid hidden and enclosed areas to allow for casual surveillance where practicable,
- where hidden and enclosed areas such as staircases and lift lobbies cannot be avoided,
- are to include mirrors or similar devices to aid surveillance,
- are to be well ventilated, and
- are to provide natural rather than mechanical ventilation where practicable.

C.03 To facilitate adaptation of car parking to other uses in the long term, consideration will be given to car parking remaining as part of the common property and not part of, or attached to, individual strata units.

9B.4.6 LEASING OF EXISTING SURPLUS COMMERCIAL CAR PARKING SPACES

Objectives

- O.01 To facilitate the efficient use of under-occupied car parking spaces within existing commercial buildings in the Auto Alley (West).
- O.02 To appropriately regulate and manage the use of Auto Alley (West) parking spaces in a manner that responds to the changing demand for car parking over time.
- O.03 To encourage greater use of under-utilised car parking so as to increase the availability of short term parking in other locations in the Auto Alley (West).

Controls

Parking spaces within an existing commercial building or commercial component of a mixed use building (but not residential parking) may, subject to development consent, be leased as parking spaces to persons or businesses who do not occupy that building, as provided in Clause 7.17 of *Parramatta LEP 2023*.

Note: Commercial buildings may include activities such as retail premises, business premises, office premises, restaurants, and cafes.

The following criteria must be satisfied:

- C.01 The number of surplus spaces in the building must be specified, justified and shown on a site plan submitted with the Development Application. The number of surplus spaces represents the number of spaces above the maximum number required for the floorspace in the building based on the current car parking rates.
- C.02 There is demand for take up of this car parking by other commercial enterprises within the Auto Alley (West).
- C.03 The car parking layout and circulation routes, both pedestrian and vehicular are safe and suitable.
- C.04 To promote the orderly and efficient use of surplus parking, spaces will only be permitted to be leased for long term parking (a minimum continuous period of one month).

Any consent granted under this Section will apply for 2 years from the time the consent is issued. After that period, a new Development Application will be required.

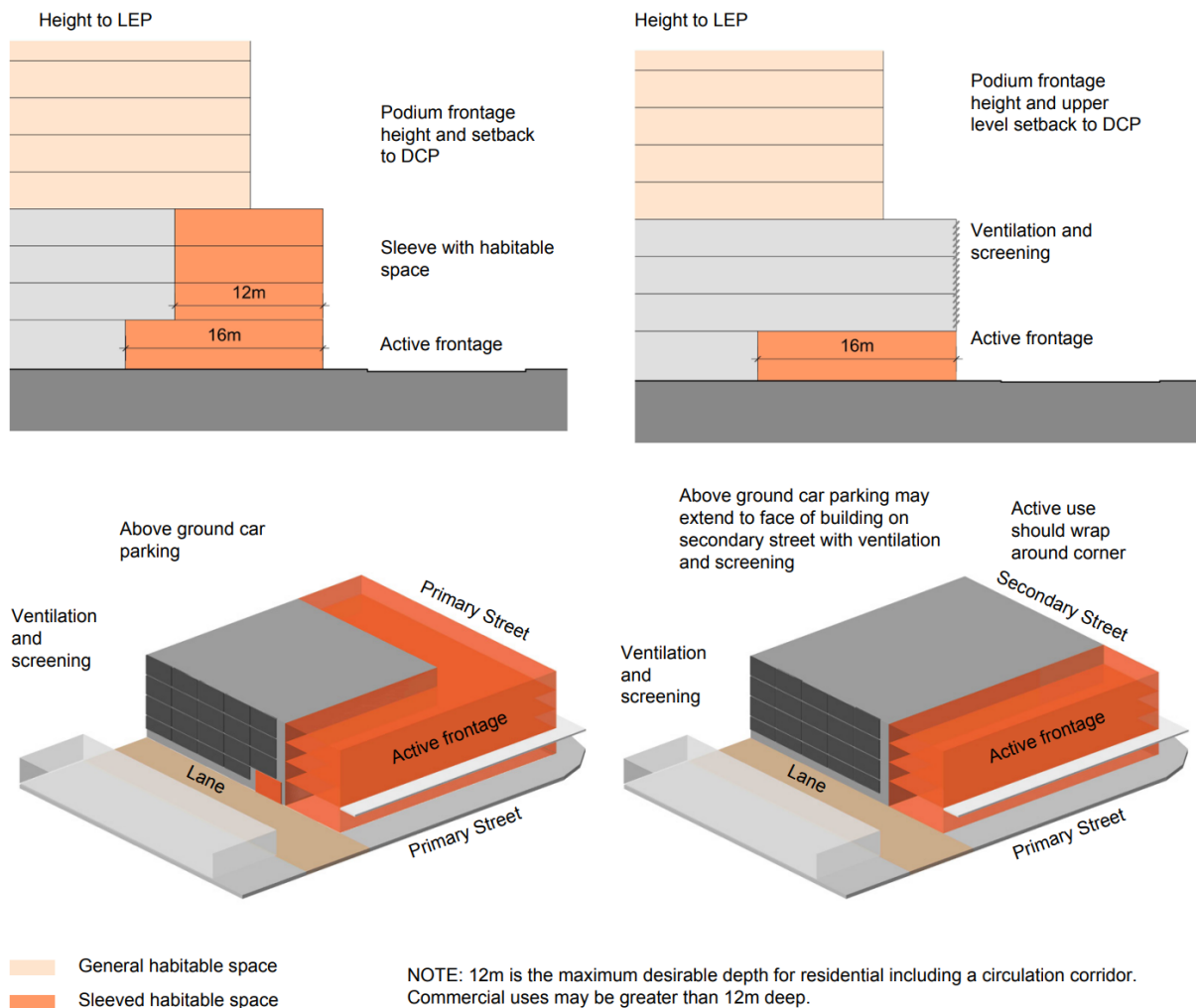

Figure 9B.4.2 – Frontage Treatments for Above Ground Car parking



Figure 9B.4.3 – Above Ground Carparking Frontage Treatments

9B.5 ENVIRONMENTAL MANAGEMENT

9B.5.1 LANDSCAPE DESIGN

Objectives

- O.01 To ensure landscaping is integrated into the design of development within the Auto Alley (West).
- O.02 To encourage well designed landscaping that ameliorates heat bank effects in the Auto Alley (West).

Controls

- C.01 Commercial and retail developments are to incorporate planting in accessible outdoor spaces such as courtyards, forecourts, terraces and roofs.
- C.02 A landscape concept plan must be provided for all landscaped areas. The plan must outline how landscaped areas are to be maintained for the life of the development.
- C.03 Street trees are to be provided in the footpath in accordance with the street tree mapping in Council's [Parramatta Public Domain Guidelines](#).
- C.04 Landscaping of city buildings should consider the use of 'green walls' in appropriate locations.

- C.05 Basement car parks should be contained predominantly within building footprints to allow for deep soil beneath forecourts and courtyards for canopy tree planting.

9B.5.2 PLANTING ON STRUCTURES

Constraints on the location of car parking structures due to water table conditions may mean that landscaping might need to be provided over parking structures, on roof tops or on walls. The following controls apply in these conditions.

Objectives

- O.01 To contribute to the landscape quality and amenity of buildings within the Auto Alley (West).
- O.02 To encourage the establishment and healthy growth of landscaping in urban areas within the Auto Alley (West).

Controls

- C.01 Design for optimum conditions for plant growth by:
- providing soil depth, soil volume, and soil area appropriate to the size of the plants to be established,
 - providing appropriate soil conditions including irrigation (where possible using recycled water) and suitable drainage.
- C.02 Design planters to support the appropriate soil depth and plant selection by:
- ensuring planter proportions accommodate the largest volume of soil possible and soil depths to ensure tree growth, and
 - providing square or rectangular planting areas rather than narrow linear areas.
- C.03 Provide sufficient soil depth and area to allow for plant establishment and growth. The following minimum standards are recommended:

Table 9B.5.2.1 – Minimum soil depth for plant establishment

Plant type	Min soil depth	Min soil volume
Large trees (over 8m high)	1.3m	150m ³
Medium trees (2m to 8m high)	1.0m	35m ³
Small trees (up to 2m high)	800mm	9m ³
Shrubs and ground cover	500mm	N/A

9B.5.3 GREEN ROOFS

A green roof or living roof is a roof of a building that is partially or completely covered with vegetation and a growing medium, planted over a waterproofing membrane. Container gardens on roofs, where plants are maintained in pots, are not considered to be green roofs.

Objectives

- O.01 To promote the use of green roofs to assist with reduction of energy use, improve stormwater management, enhance environmental biodiversity and reduce urban heat island effects.

Controls

- C.01 Buildings are encouraged to include a green roof component on the roof space.

9B.5.4 ENERGY AND WATER EFFICIENT DESIGN

In addition to the objectives and principles in Section 5.4 – Environmental Performance the following objectives also apply to the Auto Alley (West).

- O.01 Non-residential developments should be designed to meet a minimum rating of 5 Green Star Office Design.
- O.02 Any building refurbishment with a value greater than \$500,000 should result in a refurbished building with an estimate minimum 3.5 NABERS star rating.

9B.5.5 RECYCLED WATER

New developments should be connected to a source of recycled or reuse water wherever possible. Recycled/reuse water means treating and using water, such as sewage, stormwater, industrial wastewater or greywater, for non-drinking purposes such as for industry, toilets, cooling towers and irrigation of gardens, lawns, parks, and crops.

Objectives

- O.01 To increase the resilience of the City to interruptions in supply and during droughts by providing an alternative water supply to City buildings in the Auto Alley (West).
- O.02 To defer the need to invest in new potable water supply infrastructure to supply future demand in the City.
- O.03 To support the recycled water targets of the State Government's 'Metropolitan Water Plan'.

Controls

- C.01 Dual reticulation (dual pipe) systems should be installed in new commercial, industrial and mixed use buildings, with the dual reticulation system being of sufficient size to supply all non-potable water uses of the building.
- C.02 Use of building or precinct level water harvesting/treatment systems to reduce or eliminate non-potable water demand is encouraged.